



PART NAME

PTH MOUNTING PLATE (STEEL)

PART No.

PTX-22510

REVISION DATE 10-20-17

**DRAWING FOR REFERENCE**  
 WE RESERVE THE RIGHT TO MAKE CHANGES TO OUR STANDARD PRODUCTS. PLEASE CONSULT WITH BUD INDUSTRIES PRIOR TO USING THIS DRAWING FOR DESIGN PURPOSE.

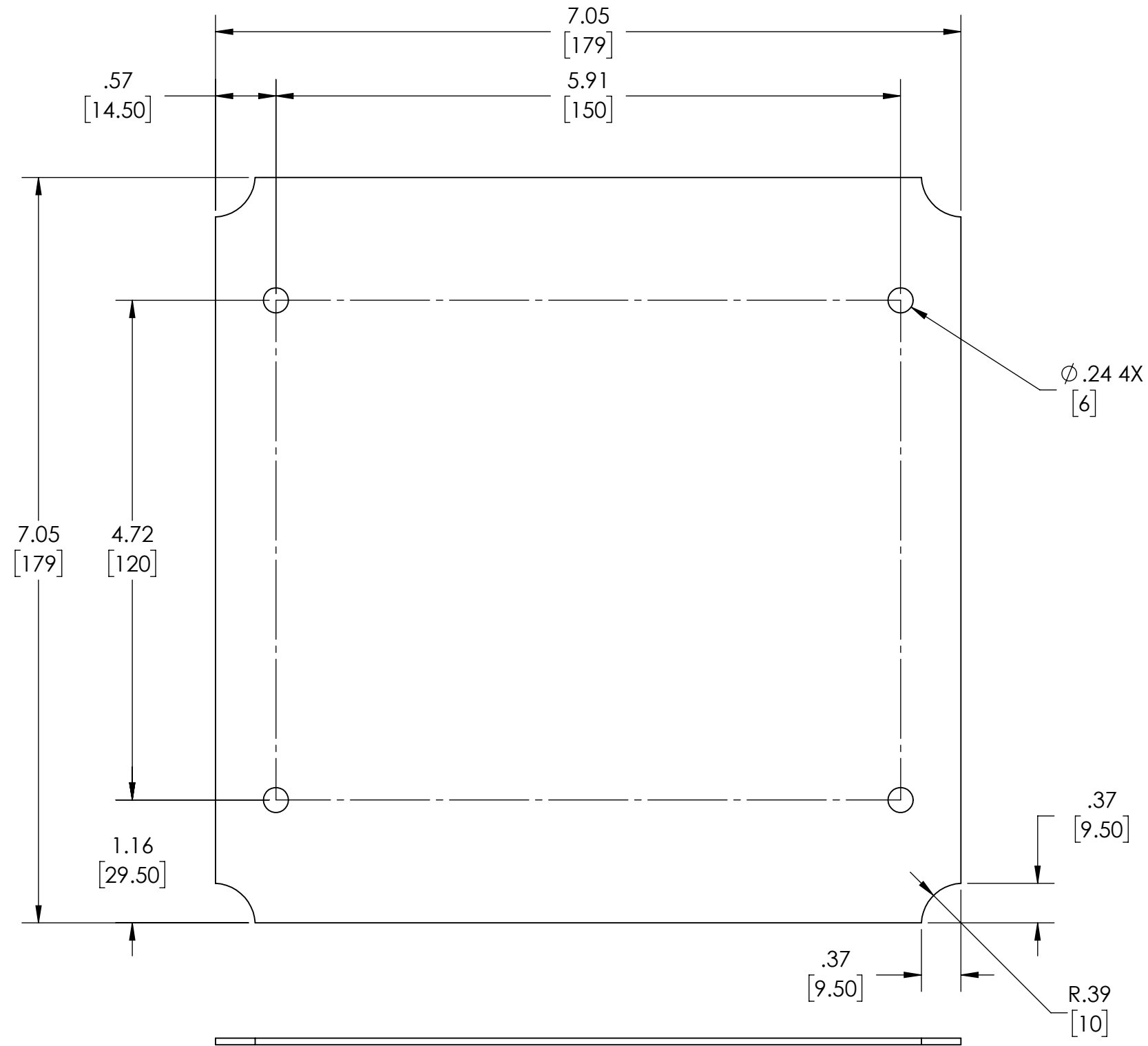

MATERIAL - .063 [1.6mm] THK. STEEL, ZINC PLATE

DIMENSIONS ARE INCH[MM]

 PANEL FITS THE FOLLOWING ENCLOSURES:  
 PTH-22510 & PTH-22510-C