

# TIGER EYE™ FLAT IDC WIRE CABLES

(1.27 mm) .050" PITCH • FFSD SERIES

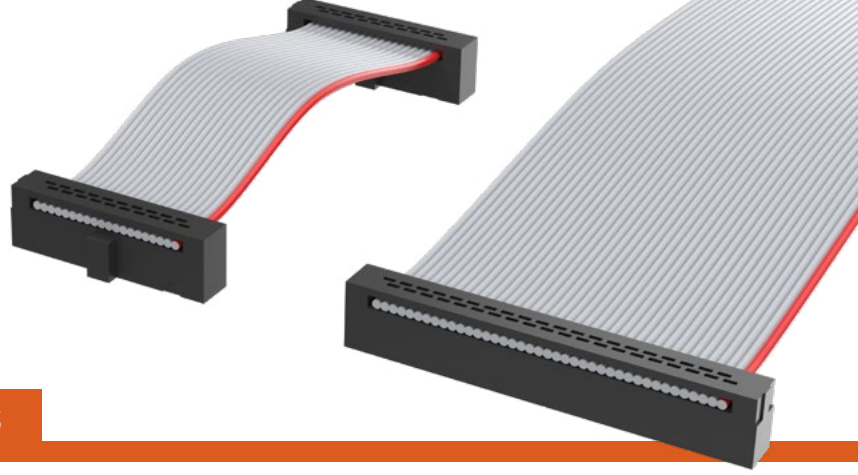

## FFSD

### Mates:

FTS, FTSH, EHF,  
SHF, ESHF

## SPECIFICATIONS

### Insulator Material:

PBT

### Contact:

BeCu

### Plating:

10 μ" (0.25 μm) Au over 50 μ"  
(1.27 μm) Ni on contact area;  
Sn over 50 μ" (1.27 μm) Ni  
on balance

### Wire:

30 AWG

### Current Rating (FFSD/FTSH):

2.3 A per pin  
(2 pins powered)

### Operating Temp Range:

-40 °C to +105 °C

### Lead Size Accepted:

(0.41 mm) .016" SQ

### Insertion Depth:

(2.64 mm) .104" to  
(3.17 mm) .125"

## ALSO AVAILABLE

Other Sizes  
(MOQ Required)

SERIES	NO. PINS PER ROW	END OPTION	OVERALL LENGTH	01	N	OTHER OPTION
--------	------------------	------------	----------------	----	---	--------------

**FFSD**  
= Socket Strip

**-04, -05, -06, -08, -10, -11, -12, -13, -15, -17, -20, -25**  
(Standard sizes)

**-S**  
= Single End  
**-D**  
= Double End

**-"XX.XX"**  
= Assembled Length

**-N**  
= Notch Polarization (Notch option not available with -04 position)

**-RW**  
= Reverse Wiring (Red wire opposite position #1)

**-D "XX"**  
= Daisy Chain

**-SR**  
= Strain Relief (Mates only with ESHF Series) (Not available with -O, -M, -R or -DXX)

**-R**  
= Reverse

**-M**  
= Middle Reverse (Requires -DXX)

**-O**  
= Outside Reverse (Requires -DXX)

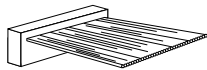
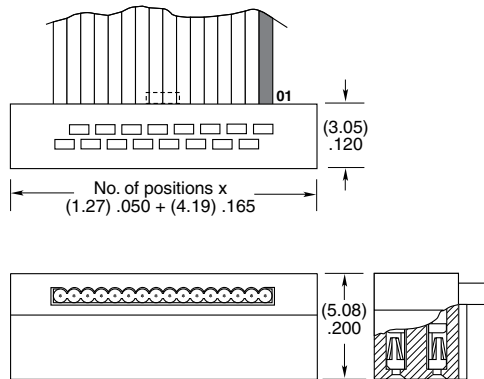

Single End (-S)

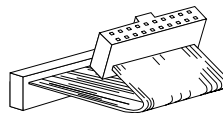

Double End (-D)

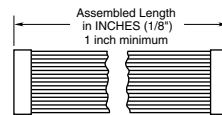

Assembled Length (-"XX.XX")

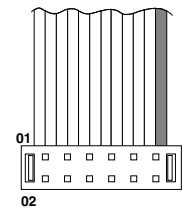

Reverse Wiring (-RW)

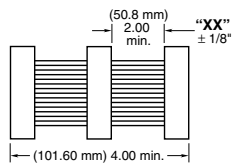

Daisy Chain (-D "XX")

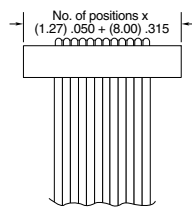

Strain Relief (-SR)

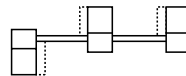

Reverse (-R)

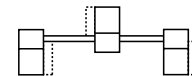

Middle Reverse (-M)

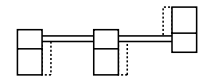

Outside Reverse (-O)

### Note:

This Series is non-standard, non-returnable.