

## SOD-123 Plastic-Encapsulate Diodes

### MBR0520-MBR0580 Schottky Barrier Diode

#### FEATURES

- Lead Free Finish/RoHS Compliant
- Extremely Low Thermal Resistance
- For Surface Mount Application and High Current Capability

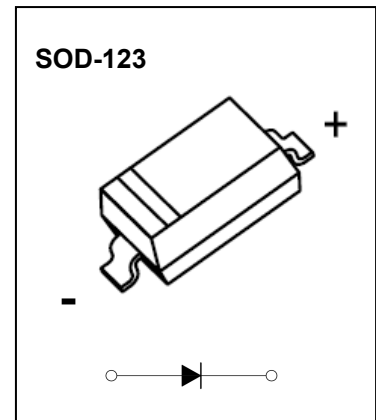

#### MARKING:

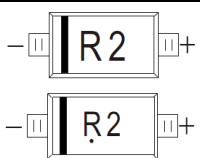
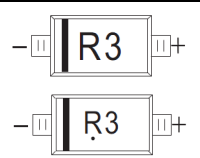
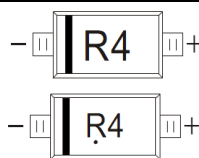
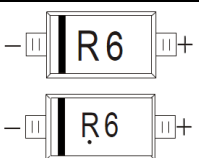
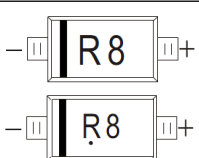
MBR0520:R2	MBR0530:R3	MBR0540:R4	MBR0560:R6	MBR0580:R8
				

The marking bar indicates the cathode  
 Solid dot = Green molding compound device, if none,  
 the normal device.

#### Maximum Ratings @T<sub>a</sub>=25°C

Parameter	Symbol	MBR	MBR	MBR	MBR	MBR	Unit
		0520	0530	0540	0560	0580	
<b>Maximum recurrent peak reverse voltage</b>	V <sub>RRM</sub>	20	30	40	60	80	V
<b>Maximum RMS voltage</b>	V <sub>RMS</sub>	14	21	28	42	56	
<b>Mean rectifying current</b>	I <sub>O</sub>	0.5					A
<b>Non-repetitive Peak forward surge current @t=8.3ms</b>	I <sub>FSM</sub>	5.5					A
<b>Power Dissipation</b>	P <sub>D</sub>	410					mW
<b>Thermal Resistance Junction to Ambient</b>	R <sub>θJA</sub>	244					°C/W
<b>Junction temperature</b>	T <sub>J</sub>	125					°C
<b>Storage temperature</b>	T <sub>stg</sub>	-55~+150					°C

---

## ELECTRICAL CHARACTERISTICS

---

$T_a=25\text{ }^\circ\text{C}$  unless otherwise specified

Parameter	Symbol	Min.	Typ.	Max.	Unit	Conditions
<b>Forward voltage</b> MBR0520 MBR0530 MBR0540 MBR0560 MBR0580	$V_F$			0.45 0.55 0.55 0.70 0.80	V	$I_F=500\text{mA}$
<b>Reverse current</b> MBR0520 MBR0530 MBR0540 MBR0560 MBR0580	$I_R$			80	$\mu\text{A}$	$V_R=20\text{V}$ $V_R=30\text{V}$ $V_R=40\text{V}$ $V_R=60\text{V}$ $V_R=80\text{V}$
<b>Capacitance between terminals</b>	$C_T$		30		pF	$V_R=4\text{V}$ , $f=1\text{MHZ}$

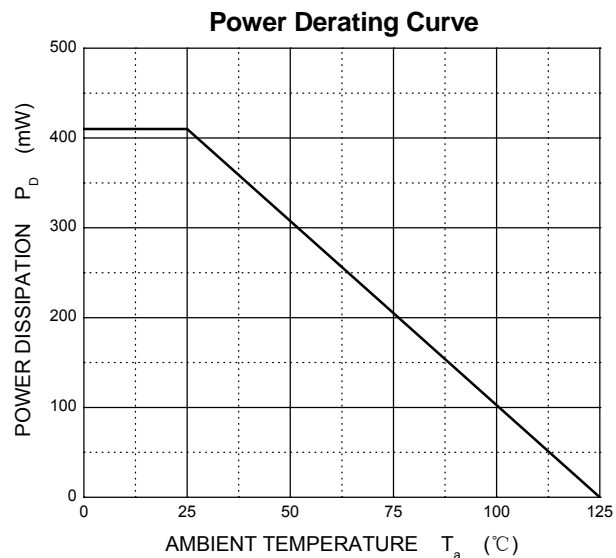
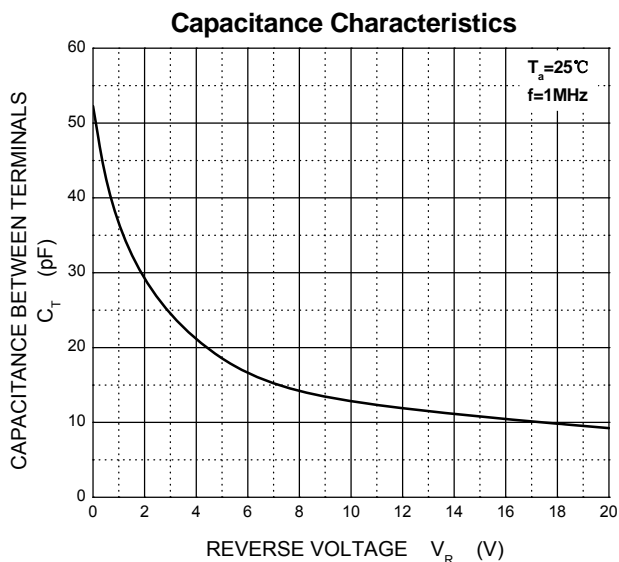
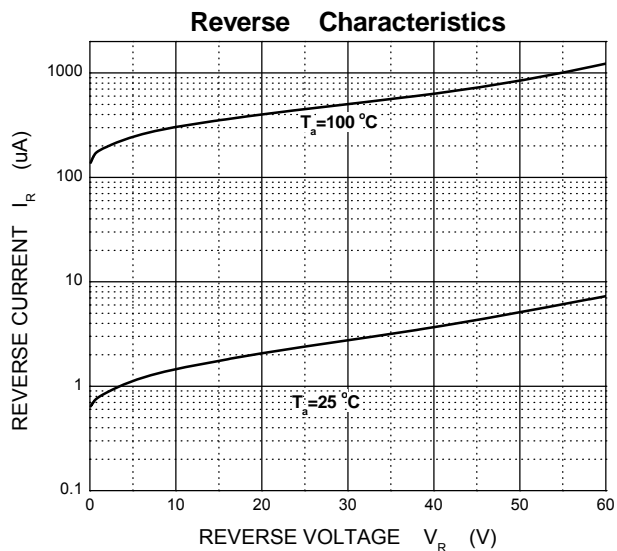
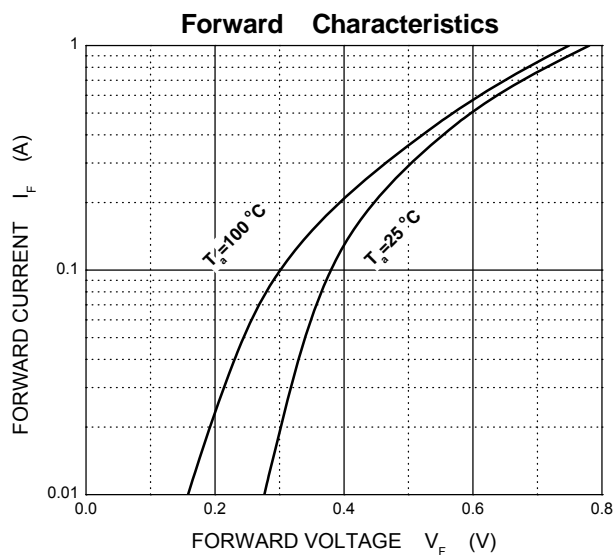

## SOD-123 Package Outline Dimensions

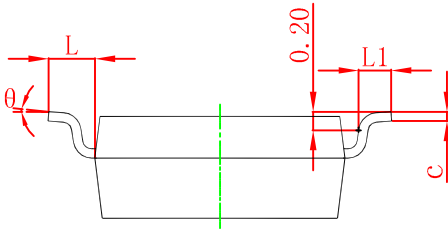
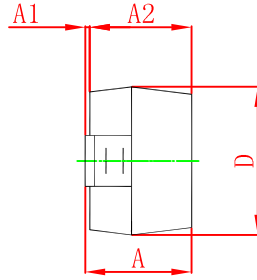
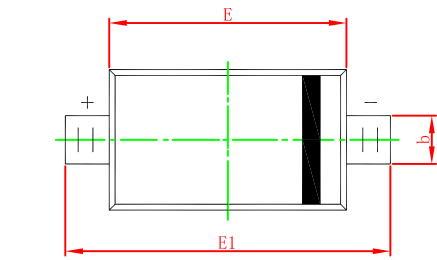

Symbol	Dimensions In Millimeters		Dimensions In Inches	
	Min	Max	Min	Max
A	1.050	1.250	0.041	0.049
A1	0.000	0.100	0.000	0.004
A2	1.050	1.150	0.041	0.045
b	0.450	0.650	0.018	0.026
c	0.080	0.150	0.003	0.006
D	1.500	1.700	0.059	0.067
E	2.600	2.800	0.102	0.110
E1	3.550	3.850	0.140	0.152
L	0.500 REF		0.020 REF	
L1	0.250	0.450	0.010	0.018
θ	0°	8°	0°	8°

## SOD-123 Suggested Pad Layout

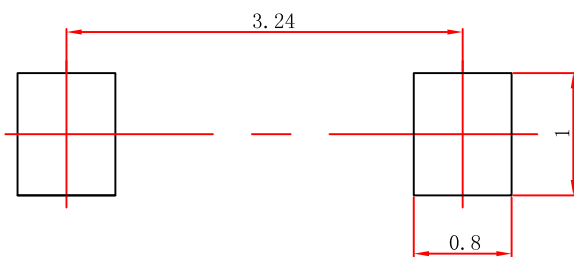

### Note:

1. Controlling dimension: in millimeters.
2. General tolerance:  $\pm 0.05\text{mm}$ .
3. The pad layout is for reference purposes only.

### NOTICE

JCET reserve the right to make modifications, enhancements, improvements, corrections or other changes without further notice to any product herein. JCET does not assume any liability arising out of the application or use of any product described herein.

# SOD-123 Tape and Reel

## SOD-123 Embossed Carrier Tape

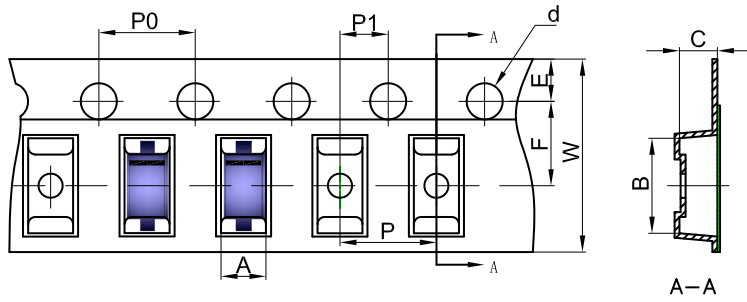

### Packaging Description:

SOD-123 parts are shipped in tape. The carrier tape is made from a dissipative (carbon filled) polycarbonate resin. The cover tape is a multilayer film (Heat Activated Adhesive in nature) primarily composed of polyester film, adhesive layer, sealant, and anti-static sprayed agent. These reeled parts in standard option are shipped with 3,000 units per 7" or 17.8cm diameter reel. The reels are clear in color and is made of polystyrene plastic (anti-static coated).

Dimensions are in millimeter											
Pkg type	A	B	C	d	E	F	P0	P	P1	W	
SOD-123	1.85	3.95	1.57	Ø1.55	1.75	3.50	4.00	4.00	2.00	8.00	

## SOD-123 Tape Leader and Trailer

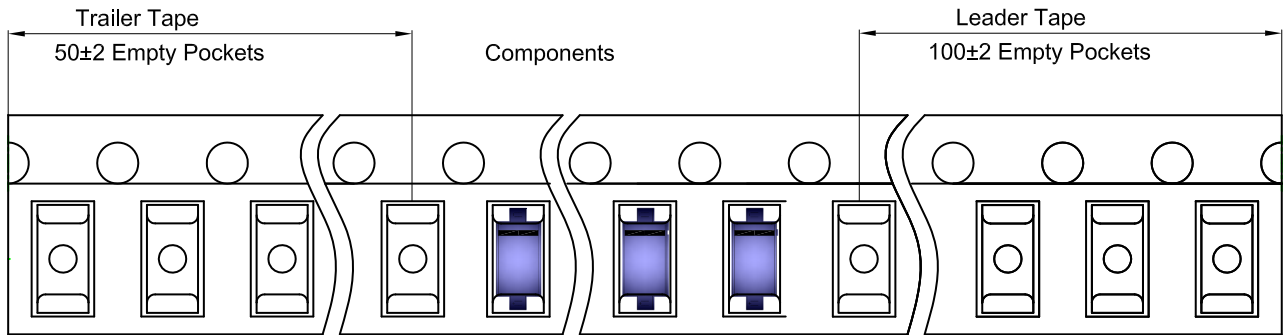

## SOD-123 Reel

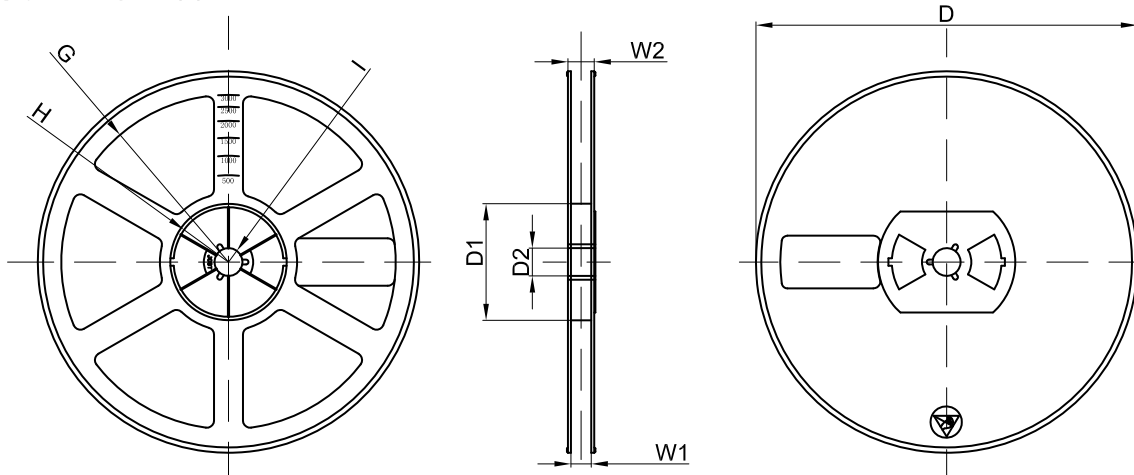

Dimensions are in millimeter								
Reel Option	D	D1	D2	G	H	I	W1	W2
7"Dia	Ø178.00	54.40	13.00	R78.00	R25.60	R6.50	9.50	12.30

REEL	Reel Size	Box	Box Size(mm)	Carton	Carton Size(mm)	G.W.(kg)
3000 pcs	7 inch	45,000 pcs	203×203×195	180,000 pcs	438×438×220	