

General Purpose Transistors

PNP Silicon

These transistors are designed for general purpose amplifier applications. They are housed in the SOT-323/SC-70 which is designed for low power surface mount applications.

Features

We declare that the material of product compliance with RoHS requirements.

MAXIMUM RATINGS

Rating	Symbol	BC856	BC857	BC858	Unit
Collector-Emitter Voltage	V_{CEO}	-65	-45	-30	V
Collector-Base Voltage	V_{CBO}	-80	-50	-30	V
Emitter-Base Voltage	V_{EBO}	-5.0	-5.0	-5.0	V
Collector Current — Continuous	I_C	-100	-100	-100	mAdc

LBC856AWT1G, BWT1G
 LBC857AWT1G, BWT1G
 CWT1G
 LBC858AWT1G, BWT1G
 CWT1G
 S-LBC856AWT1G, BWT1G
 S-LBC857AWT1G, BWT1G
 CWT1G
 S-LBC858AWT1G, BWT1G
 CWT1G

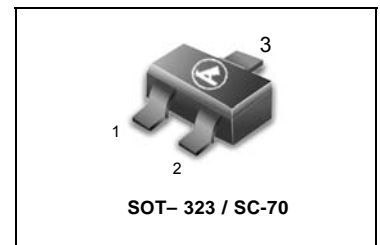

THERMAL CHARACTERISTICS

Characteristic	Symbol	Max	Unit
Total Device Dissipation FR-5 Board, (1) $T_A = 25^\circ\text{C}$	P_D	150	mW
Thermal Resistance, Junction to Ambient	$R_{\theta JA}$	833	$^\circ\text{C/W}$
Junction and Storage Temperature	T_J, T_{stg}	-55 to +150	$^\circ\text{C}$

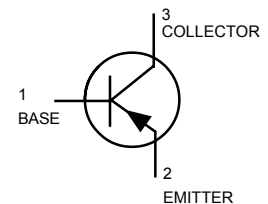

DEVICE MARKING

S-LBC856AWT1G= 3A; S-LBC856BWT1G= 3B; S-LBC857AWT1G= 3E; S-LBC857BWT1G = 3F;
 S-LBC857CWT1G= 3G; S-LBC858AWT1G= 3J; S-LBC858BWT1G= 3K; S-LBC858CWT1G= 3L

ELECTRICAL CHARACTERISTICS ($T_A = 25^\circ\text{C}$ unless otherwise noted.)

Characteristic	Symbol	Min	Typ	Max	Unit
----------------	--------	-----	-----	-----	------

OFF CHARACTERISTICS

Collector-Emitter Breakdown Voltage ($I_C = -10\text{ mA}$)	LBC856 Series	-65	—	—	
	LBC857 Series	$V_{(BR)CEO}$	-45	—	v
	LBC858 Series	-30	—	—	
Collector-Emitter Breakdown Voltage ($I_C = -10\ \mu\text{A}, V_{EB} = 0$)	LBC856 Series	-80	—	—	
	LBC857B Only	$V_{(BR)CES}$	-50	—	v
	LBC858 Series	-30	—	—	
Collector-Base Breakdown Voltage ($I_C = -10\ \mu\text{A}$)	LBC856 Series	-80	—	—	
	LBC857 Series	$V_{(BR)CBO}$	-50	—	v
	LBC858 Series	-30	—	—	
Emitter-Base Breakdown Voltage ($I_E = -1.0\ \mu\text{A}$)	LBC856 Series	-5.0	—	—	
	LBC857 Series	$V_{(BR)EBO}$	-5.0	—	v
	LBC858 Series	-5.0	—	—	
Collector Cutoff Current ($V_{CB} = -30\text{ V}$) ($V_{CB} = -30\text{ V}, T_A = 150^\circ\text{C}$)		I_{CBO}	—	-15	nA
			—	-4.0	μA

1.FR-5=1.0 x 0.75 x 0.062in

**LBC856AWT1G, BWT1G LBC857AWT1G, BWT1G,CWT1G LBC858AWT1G, BWT1G, CWT1G
S-LBC856AWT1G, BWT1G S-LBC857AWT1G, BWT1G,CWT1G S-LBC858AWT1G, BWT1G, CWT1G**

ELECTRICAL CHARACTERISTICS ($T_A = 25^\circ\text{C}$ unless otherwise noted) (Continued)

Characteristic	Symbol	Min	Typ	Max	Unit
----------------	--------	-----	-----	-----	------

ON CHARACTERISTICS

DC Current Gain ($I_C = -2.0\text{ mA}, V_{CE} = -5.0\text{ V}$)	h_{FE}				—
LBC856A, LBC857A, LBC858A		125	180	250	
LBC856B, LBC857B, LBC858B		220	290	475	
LBC857C, LBC858C		420	520	800	
Collector–Emitter Saturation Voltage ($I_C = -10\text{ mA}, I_B = -0.5\text{ mA}$) ($I_C = -100\text{ mA}, I_B = -5.0\text{ mA}$)	$V_{CE(sat)}$	—	—	-0.3 -0.65	V
Base–Emitter Saturation Voltage ($I_C = -10\text{ mA}, I_B = -0.5\text{ mA}$) ($I_C = -100\text{ mA}, I_B = -5.0\text{ mA}$)	$V_{BE(sat)}$	—	-0.7 -0.9	—	V
Base–Emitter Voltage ($I_C = -2.0\text{ mA}, V_{CE} = -5.0\text{ V}$) ($I_C = -10\text{ mA}, V_{CE} = -5.0\text{ V}$)	$V_{BE(on)}$	-0.6	—	-0.75 -0.82	V

SMALL–SIGNAL CHARACTERISTICS

Current–Gain — Bandwidth Product ($I_C = -10\text{ mA}, V_{CE} = -5.0\text{ Vdc}, f = 100\text{ MHz}$)	f_T	100	—	—	MHz
Output Capacitance ($V_{CB} = -10\text{ V}, f = 1.0\text{ MHz}$)	C_{ob}	—	—	4.5	pF
Noise Figure ($I_C = -0.2\text{ mA}, V_{CE} = -5.0\text{ Vdc}, R_S = 2.0\text{ k}\Omega, f = 1.0\text{ kHz}, BW = 200\text{ Hz}$)	NF	—	—	10	dB

ORDERING INFORMATION (Pb–Free)

Device	Package	Shipping
LBC856AWT1G series	SOT-23	3000/Tape & Reel
LBC856AWT3G series	SOT-23	10000/Tape & Reel

LBC856AWT1G, BWT1G LBC857AWT1G, BWT1G, CWT1G LBC858AWT1G, BWT1G, CWT1G
 S-LBC856AWT1G, BWT1G S-LBC857AWT1G, BWT1G, CWT1G S-LBC858AWT1G, BWT1G, CWT1G

LBC857/LBC858

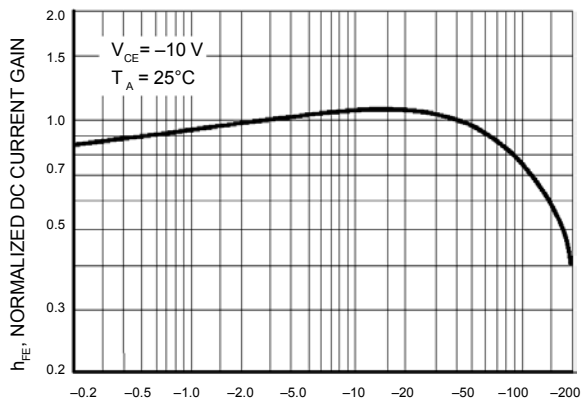

I_C , COLLECTOR CURRENT (mAdc)
Figure 1. Normalized DC Current Gain

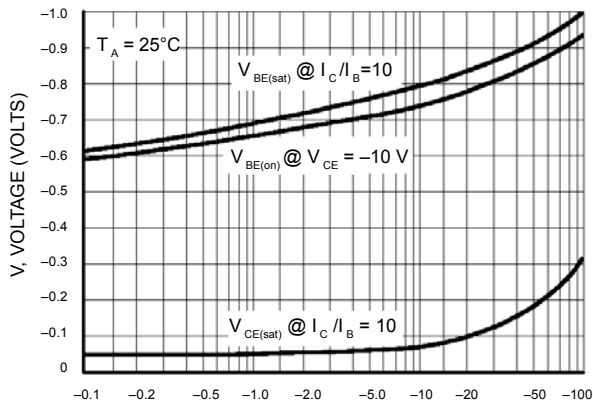

I_C , COLLECTOR CURRENT (mAdc)
Figure 2. "Saturation" and "On" Voltages

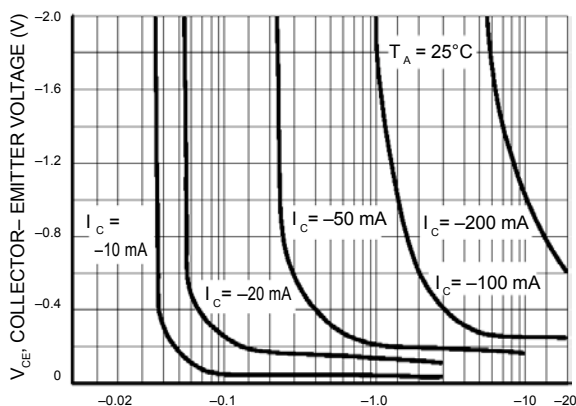

I_B , BASE CURRENT (mA)
Figure 3. Collector Saturation Region

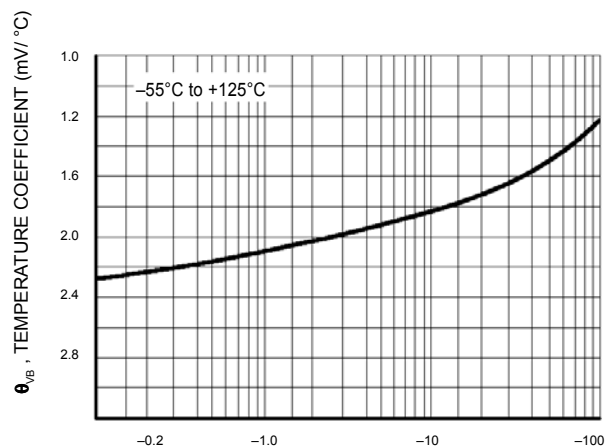

I_C , COLLECTOR CURRENT (mA)
Figure 4. Base-Emitter Temperature Coefficient

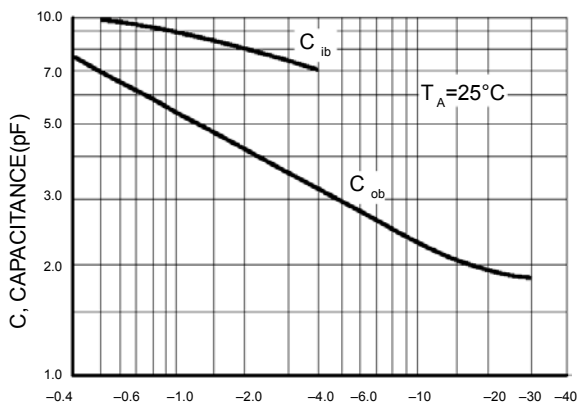

V_R , REVERSE VOLTAGE (VOLTS)
Figure 5. Capacitances

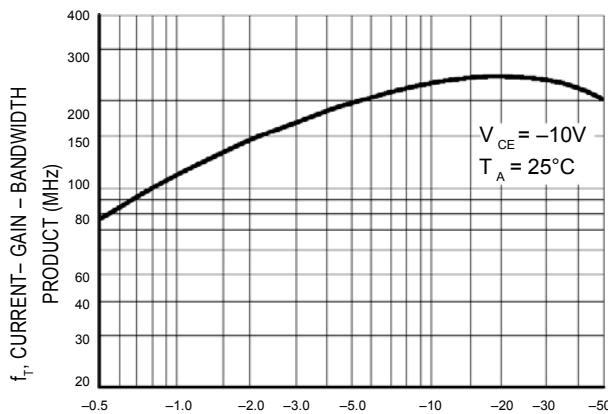

I_C , COLLECTOR CURRENT (mAdc)
Figure 6. Current-Gain - Bandwidth Product

LBC856AWT1G, BWT1G LBC857AWT1G, BWT1G, CWT1G LBC858AWT1G, BWT1G, CWT1G
 S-LBC856AWT1G, BWT1G S-LBC857AWT1G, BWT1G, CWT1G S-LBC858AWT1G, BWT1G, CWT1G

LBC856

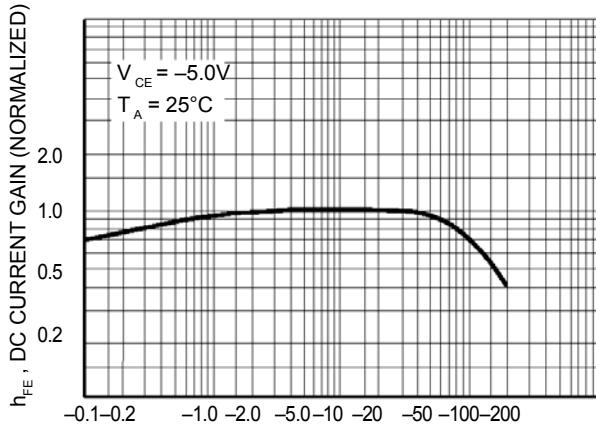

Figure 7. DC Current Gain

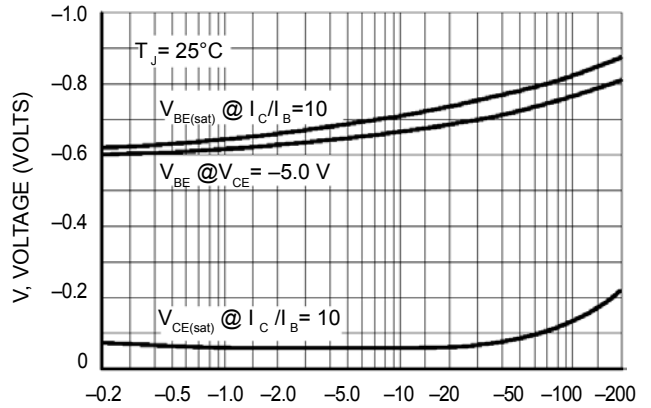

Figure 8. "On" Voltage

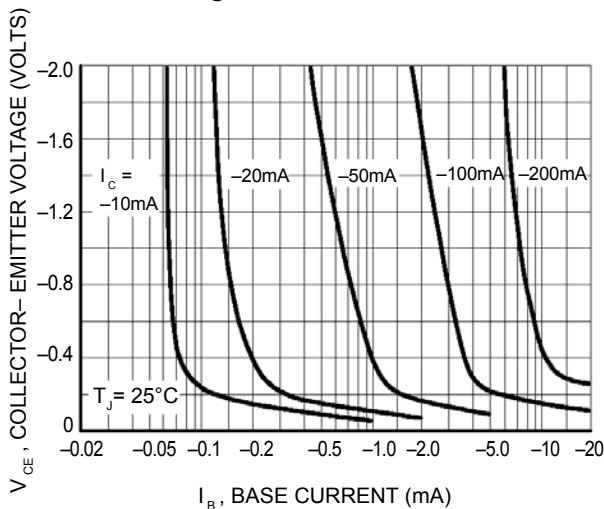

Figure 9. Collector Saturation Region

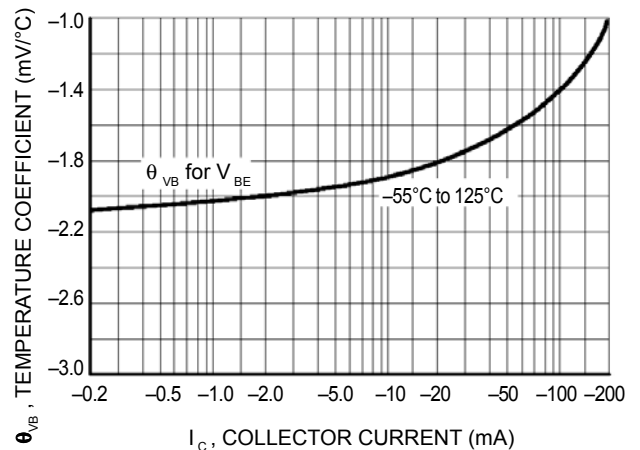

Figure 10. Base-Emitter Temperature Coefficient

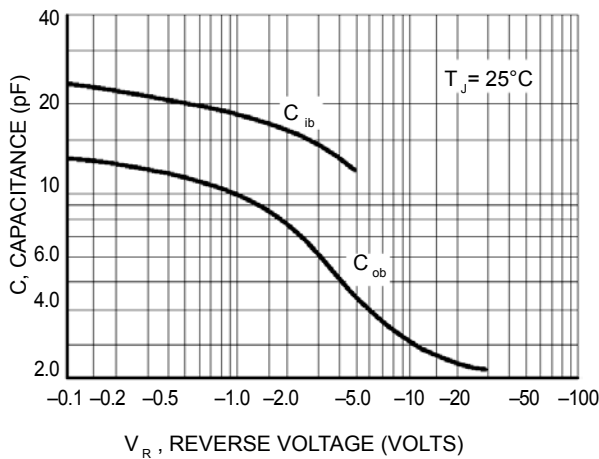

Figure 11. Capacitance

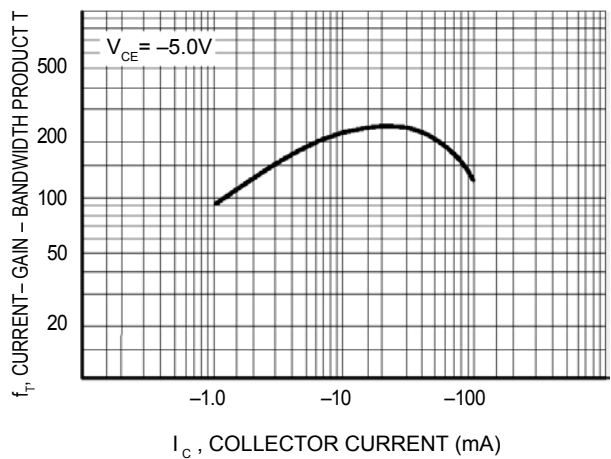

Figure 12. Current-Gain - Bandwidth Product

LBC856AWT1G, BWT1G LBC857AWT1G, BWT1G, CWT1G LBC858AWT1G, BWT1G, CWT1G
 S-LBC856AWT1G, BWT1G S-LBC857AWT1G, BWT1G, CWT1G S-LBC858AWT1G, BWT1G, CWT1G

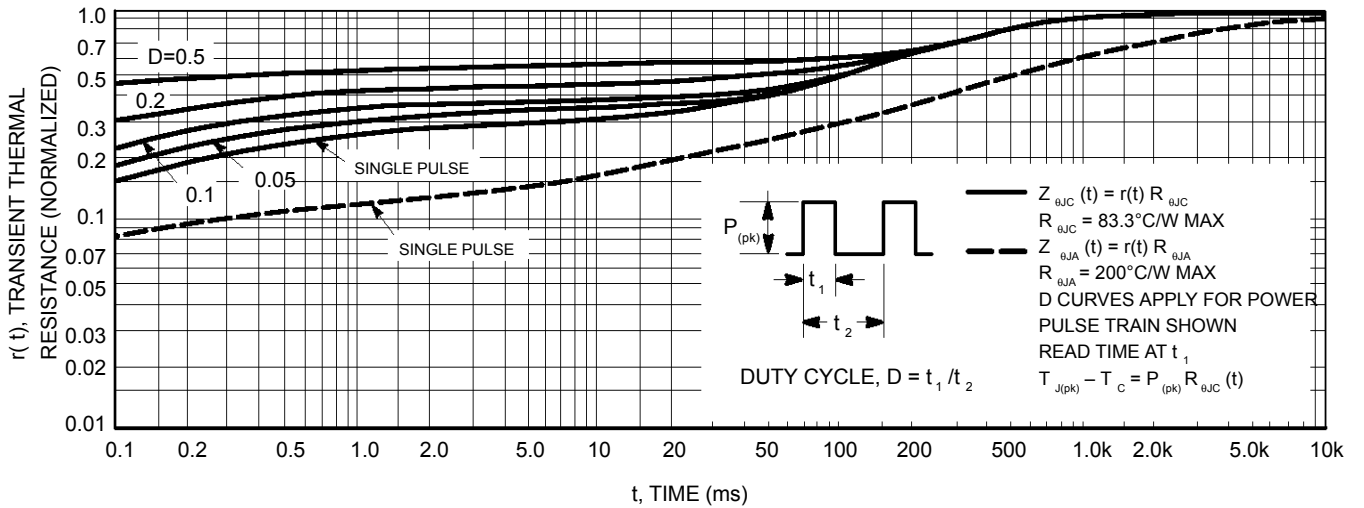

Figure 13. Thermal Response

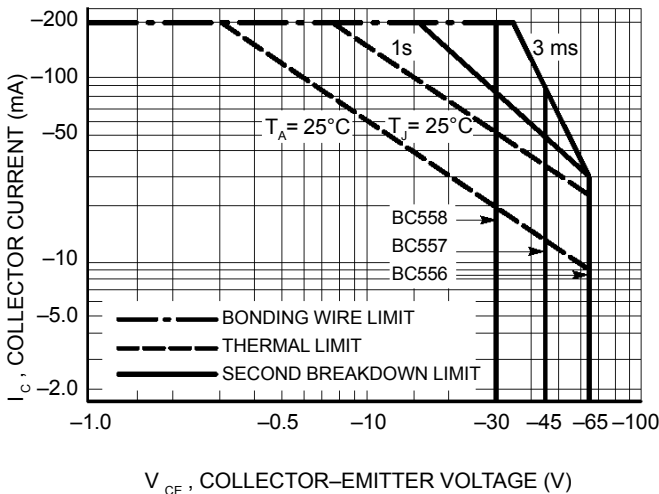

Figure 14. Active Region Safe Operating Area

The safe operating area curves indicate $I_C - V_{CE}$ limits of the transistor that must be observed for reliable operation. Collector load lines for specific circuits must fall below the limits indicated by the applicable curve.

The data of Figure 14 is based upon $T_{J(pk)} = 150^\circ\text{C}$; T_C or T_A is variable depending upon conditions. Pulse curves are valid for duty cycles to 10% provided $T_{J(pk)} \leq 150^\circ\text{C}$. $T_{J(pk)}$ may be calculated from the data in Figure 13. At high case or ambient temperatures, thermal limitations will reduce the power that can be handled to values less than the limitations imposed by the secondary breakdown.

LBC856AWT1G, BWT1G LBC857AWT1G, BWT1G, CWT1G LBC858AWT1G, BWT1G, CWT1G
 S-LBC856AWT1G, BWT1G S-LBC857AWT1G, BWT1G, CWT1G S-LBC858AWT1G, BWT1G, CWT1G

SC-70 / SOT-323

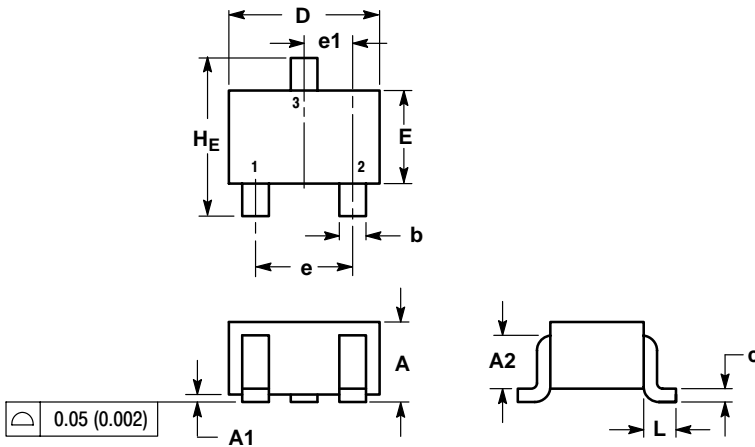

NOTES:
 1. DIMENSIONING AND TOLERANCING PER ANSI Y14.5M, 1982.
 2. CONTROLLING DIMENSION: INCH.

DIM	MILLIMETERS			INCHES		
	MIN	NOM	MAX	MIN	NOM	MAX
A	0.80	0.90	1.00	0.032	0.035	0.040
A1	0.00	0.05	0.10	0.000	0.002	0.004
A2	0.7 REF			0.028 REF		
b	0.30	0.35	0.40	0.012	0.014	0.016
c	0.10	0.18	0.25	0.004	0.007	0.010
D	1.80	2.10	2.20	0.071	0.083	0.087
E	1.15	1.24	1.35	0.045	0.049	0.053
e	1.20	1.30	1.40	0.047	0.051	0.055
e1	0.65 BSC			0.026 BSC		
L	0.425 REF			0.017 REF		
HE	2.00	2.10	2.40	0.079	0.083	0.095

GENERIC MARKING DIAGRAM

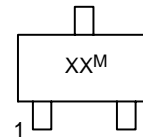

- XX = Specific Device Code
- M = Date Code
- = Pb-Free Package

*This information is generic. Please refer to device data sheet for actual part marking. Pb-Free indicator, "G" or microdot "▪", may or may not be present.

SOLDERING FOOTPRINT*

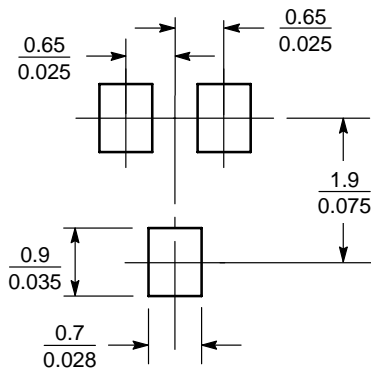

SCALE 10:1 (mm/inches)