

# 2N7002E

## Small Signal MOSFET

60 V, 310 mA, Single, N-Channel, SOT-23

### Features

- Low  $R_{DS(on)}$
- Small Footprint Surface Mount Package
- Trench Technology
- These Devices are Pb-Free, Halogen Free/BFR Free and are RoHS Compliant

### Applications

- Low Side Load Switch
- Level Shift Circuits
- DC-DC Converter
- Portable Applications i.e. DSC, PDA, Cell Phone, etc.

### MAXIMUM RATINGS (T<sub>J</sub> = 25°C unless otherwise stated)

Rating	Symbol	Value	Unit
Drain-to-Source Voltage	V <sub>DSS</sub>	60	V
Gate-to-Source Voltage	V <sub>GS</sub>	±20	V
Drain Current (Note 1) Steady State	I <sub>D</sub>	T <sub>A</sub> = 25°C	260
		T <sub>A</sub> = 85°C	190
t < 5 s	I <sub>D</sub>	T <sub>A</sub> = 25°C	310
		T <sub>A</sub> = 85°C	220
Power Dissipation (Note 1) Steady State	P <sub>D</sub>	t < 5 s	300
		t < 5 s	420
Pulsed Drain Current (t <sub>p</sub> = 10 μs)	I <sub>DM</sub>	1.2	A
Operating Junction and Storage Temperature Range	T <sub>J</sub> , T <sub>STG</sub>	-55 to +150	°C
Source Current (Body Diode)	I <sub>S</sub>	300	mA
Lead Temperature for Soldering Purposes (1/8" from case for 10 s)	T <sub>L</sub>	260	°C

Stresses exceeding those listed in the Maximum Ratings table may damage the device. If any of these limits are exceeded, device functionality should not be assumed, damage may occur and reliability may be affected.

### THERMAL CHARACTERISTICS

Characteristic	Symbol	Max	Unit
Junction-to-Ambient – Steady State (Note 1)	R <sub>θJA</sub>	417	°C/W
Junction-to-Ambient – t ≤ 5 s (Note 1)	R <sub>θJA</sub>	300	

1. Surface-mounted on FR4 board using 1 in sq pad size (Cu area = 1.127 in sq [1 oz] including traces)



ON Semiconductor®

[www.onsemi.com](http://www.onsemi.com)

V <sub>(BR)DSS</sub>	R <sub>DS(on)</sub> MAX	I <sub>D</sub> MAX (Note 1)
60 V	3.0 Ω @ 4.5 V	310 mA
	2.5 Ω @ 10 V	

### Simplified Schematic

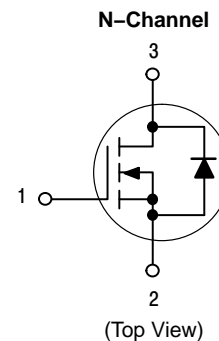

### MARKING DIAGRAM & PIN ASSIGNMENT

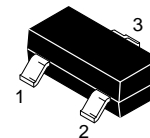

SOT-23  
CASE 318  
STYLE 21

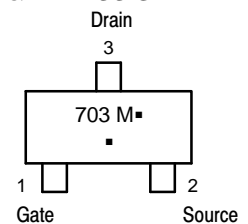

703 = Device Code  
M = Date Code  
▪ = Pb-Free Package

(Note: Microdot may be in either location)

### ORDERING INFORMATION

Device	Package	Shipping†
2N7002ET1G	SOT-23 (Pb-Free)	3000/Tape & Reel

†For information on tape and reel specifications, including part orientation and tape sizes, please refer to our Tape and Reel Packaging Specifications Brochure, BRD8011/D.

## 2N7002E

### ELECTRICAL CHARACTERISTICS ( $T_J = 25^\circ\text{C}$ unless otherwise specified)

Parameter	Symbol	Test Condition	Min	Typ	Max	Units
<b>OFF CHARACTERISTICS</b>						
Drain-to-Source Breakdown Voltage	$V_{(BR)DSS}$	$V_{GS} = 0\text{ V}, I_D = 250\ \mu\text{A}$	60			V
Drain-to-Source Breakdown Voltage Temperature Coefficient	$V_{(BR)DSS}/T_J$			75		$\text{mV}/^\circ\text{C}$
Zero Gate Voltage Drain Current	$I_{DSS}$	$V_{GS} = 0\text{ V},$ $V_{DS} = 60\text{ V}$	$T_J = 25^\circ\text{C}$		1	$\mu\text{A}$
			$T_J = 125^\circ\text{C}$		500	
Gate-to-Source Leakage Current	$I_{GSS}$	$V_{DS} = 0\text{ V}, V_{GS} = \pm 20\text{ V}$			$\pm 100$	nA

### ON CHARACTERISTICS (Note 2)

Gate Threshold Voltage	$V_{GS(TH)}$	$V_{GS} = V_{DS}, I_D = 250\ \mu\text{A}$	1.0		2.5	V
Negative Threshold Temperature Coefficient	$V_{GS(TH)}/T_J$			4.4		$\text{mV}/^\circ\text{C}$
Drain-to-Source On Resistance	$R_{DS(on)}$	$V_{GS} = 10\text{ V}, I_D = 240\text{ mA}$		0.86	2.5	$\Omega$
		$V_{GS} = 4.5\text{ V}, I_D = 50\text{ mA}$		1.1	3.0	
Forward Transconductance	$g_{FS}$	$V_{DS} = 5\text{ V}, I_D = 200\text{ mA}$		530		mS

### CHARGES AND CAPACITANCES

Input Capacitance	$C_{ISS}$	$V_{GS} = 0\text{ V}, f = 1\text{ MHz},$ $V_{DS} = 25\text{ V}$		26.7	40	$\text{pF}$
Output Capacitance	$C_{OSS}$			4.6		
Reverse Transfer Capacitance	$C_{RSS}$			2.9		
Total Gate Charge	$Q_{G(TOT)}$	$V_{GS} = 5\text{ V}, V_{DS} = 10\text{ V};$ $I_D = 240\text{ mA}$		0.81		$\text{nC}$
Threshold Gate Charge	$Q_{G(TH)}$			0.31		
Gate-to-Source Charge	$Q_{GS}$			0.48		
Gate-to-Drain Charge	$Q_{GD}$			0.08		

### SWITCHING CHARACTERISTICS, $V_{GS} = V$ (Note 3)

Turn-On Delay Time	$t_{d(ON)}$	$V_{GS} = 10\text{ V}, V_{DD} = 30\text{ V},$ $I_D = 200\text{ mA}, R_G = 10\ \Omega$		1.7		ns
Rise Time	$t_r$			1.2		
Turn-Off Delay Time	$t_{d(OFF)}$			4.8		
Fall Time	$t_f$			3.6		

### DRAIN-SOURCE DIODE CHARACTERISTICS

Forward Diode Voltage	$V_{SD}$	$V_{GS} = 0\text{ V},$ $I_S = 200\text{ mA}$	$T_J = 25^\circ\text{C}$		0.79	1.2	V
			$T_J = 85^\circ\text{C}$		0.7		

Product parametric performance is indicated in the Electrical Characteristics for the listed test conditions, unless otherwise noted. Product performance may not be indicated by the Electrical Characteristics if operated under different conditions.

2. Pulse Test: pulse width  $\leq 300\ \mu\text{s}$ , duty cycle  $\leq 2\%$
3. Switching characteristics are independent of operating junction temperatures

TYPICAL CHARACTERISTICS

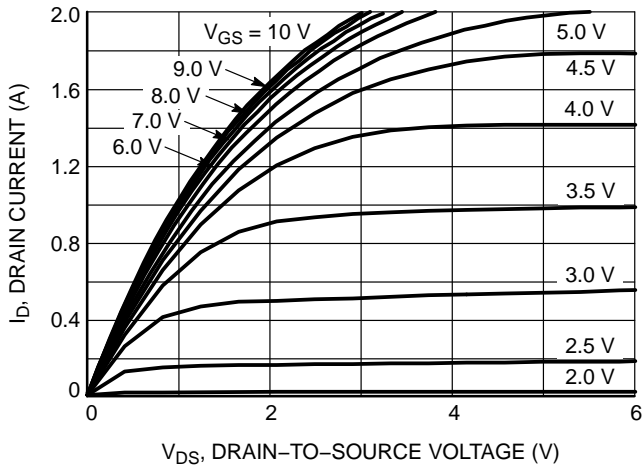

Figure 1. On-Region Characteristics

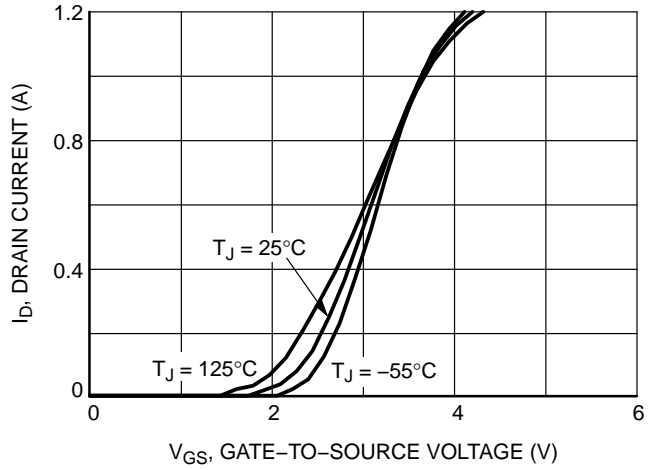

Figure 2. Transfer Characteristics

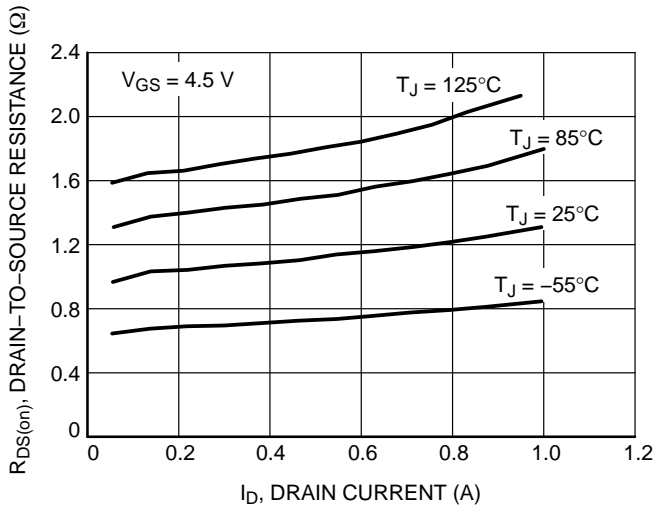

Figure 3. On-Resistance vs. Drain Current and Temperature

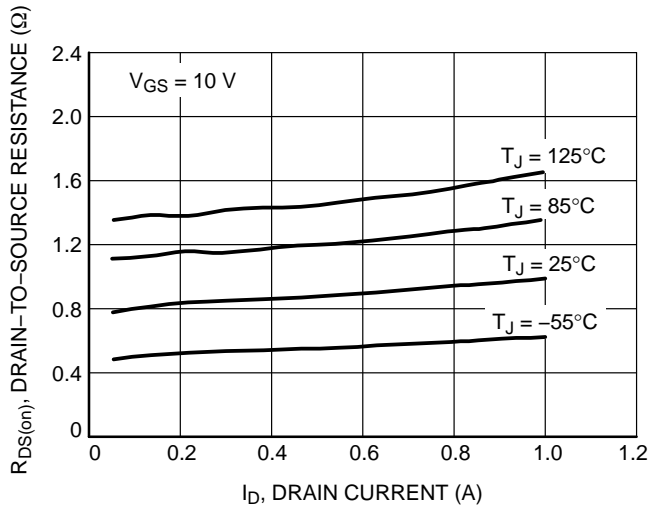

Figure 4. On-Resistance vs. Drain Current and Temperature

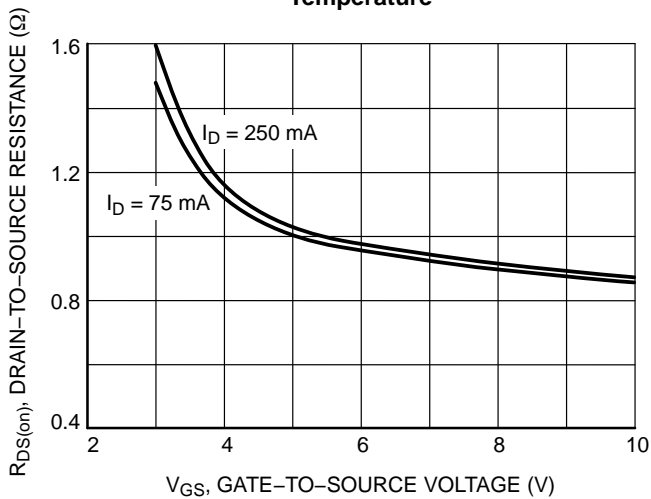

Figure 5. On-Resistance vs. Gate-to-Source Voltage

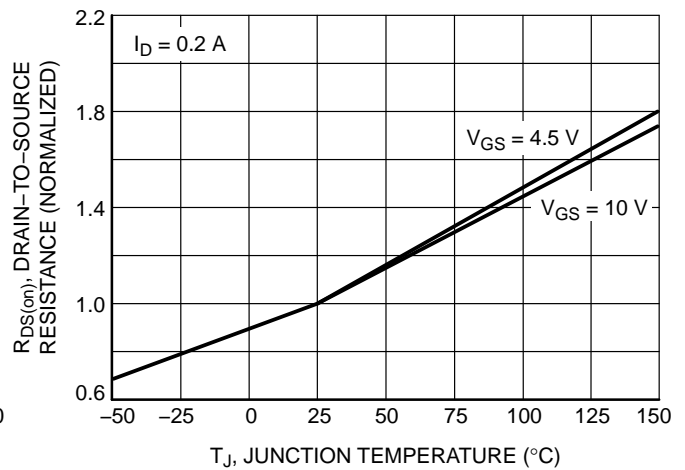

Figure 6. On-Resistance Variation with Temperature

# 2N7002E

## TYPICAL CHARACTERISTICS

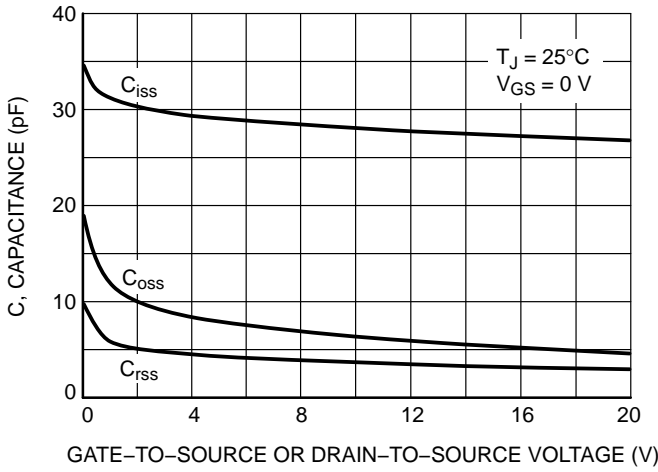

Figure 7. Capacitance Variation

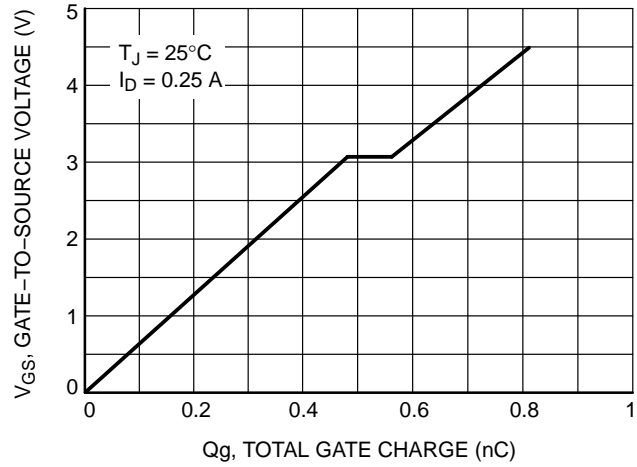

Figure 8. Gate-to-Source and Drain-to-Source Voltage vs. Total Charge

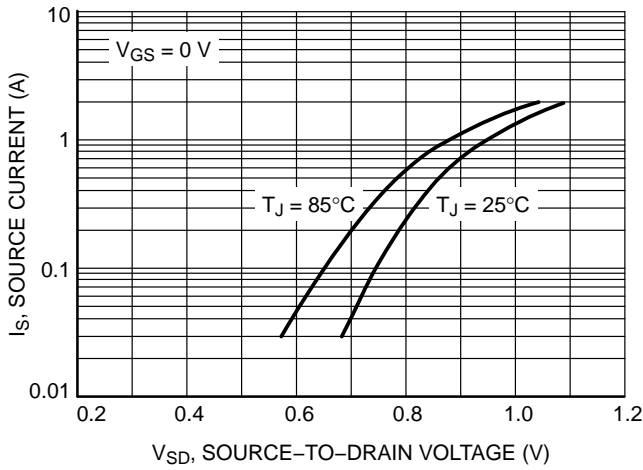

Figure 9. Diode Forward Voltage vs. Current

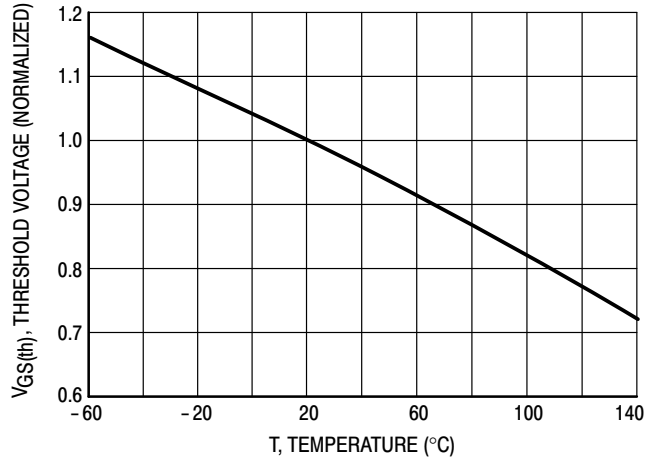
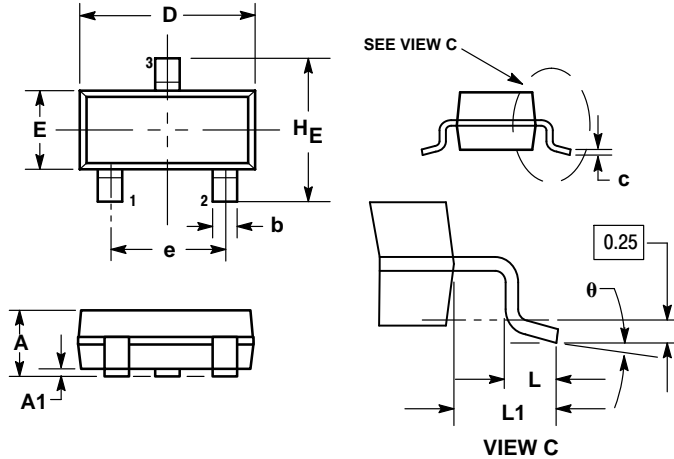

Figure 10. Temperature versus Gate Threshold Voltage

# 2N7002E

## PACKAGE DIMENSIONS

SOT-23 (TO-236)  
CASE 318-08  
ISSUE AP



NOTES:

1. DIMENSIONING AND TOLERANCING PER ANSI Y14.5M, 1982.
2. CONTROLLING DIMENSION: INCH.
3. MAXIMUM LEAD THICKNESS INCLUDES LEAD FINISH THICKNESS. MINIMUM LEAD THICKNESS IS THE MINIMUM THICKNESS OF BASE MATERIAL.
4. DIMENSIONS D AND E DO NOT INCLUDE MOLD FLASH, PROTRUSIONS, OR GATE BURRS.

DIM	MILLIMETERS			INCHES		
	MIN	NOM	MAX	MIN	NOM	MAX
A	0.89	1.00	1.11	0.035	0.040	0.044
A1	0.01	0.06	0.10	0.001	0.002	0.004
b	0.37	0.44	0.50	0.015	0.018	0.020
c	0.09	0.13	0.18	0.003	0.005	0.007
D	2.80	2.90	3.04	0.110	0.114	0.120
E	1.20	1.30	1.40	0.047	0.051	0.055
e	1.78	1.90	2.04	0.070	0.075	0.081
L	0.10	0.20	0.30	0.004	0.008	0.012
L1	0.35	0.54	0.69	0.014	0.021	0.029
HE	2.10	2.40	2.64	0.083	0.094	0.104
θ	0°	—	10°	0°	—	10°

STYLE 21:

1. GATE
2. SOURCE
3. DRAIN

### SOLDERING FOOTPRINT

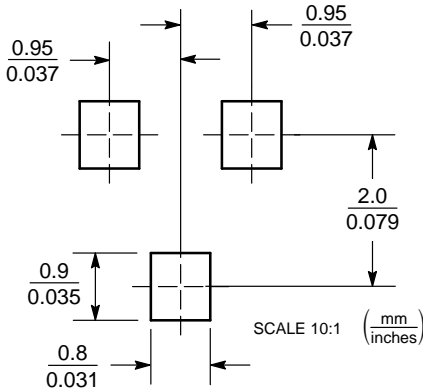

ON Semiconductor and the  are registered trademarks of Semiconductor Components Industries, LLC (SCILLC) or its subsidiaries in the United States and/or other countries. SCILLC owns the rights to a number of patents, trademarks, copyrights, trade secrets, and other intellectual property. A listing of SCILLC's product/patent coverage may be accessed at [www.onsemi.com/site/pdf/Patent-Marking.pdf](http://www.onsemi.com/site/pdf/Patent-Marking.pdf). SCILLC reserves the right to make changes without further notice to any products herein. SCILLC makes no warranty, representation or guarantee regarding the suitability of its products for any particular purpose, nor does SCILLC assume any liability arising out of the application or use of any product or circuit, and specifically disclaims any and all liability, including without limitation special, consequential or incidental damages. "Typical" parameters which may be provided in SCILLC data sheets and/or specifications can and do vary in different applications and actual performance may vary over time. All operating parameters, including "Typicals" must be validated for each customer application by customer's technical experts. SCILLC does not convey any license under its patent rights nor the rights of others. SCILLC products are not designed, intended, or authorized for use as components in systems intended for surgical implant into the body, or other applications intended to support or sustain life, or for any other application in which the failure of the SCILLC product could create a situation where personal injury or death may occur. Should Buyer purchase or use SCILLC products for any such unintended or unauthorized application, Buyer shall indemnify and hold SCILLC and its officers, employees, subsidiaries, affiliates, and distributors harmless against all claims, costs, damages, and expenses, and reasonable attorney fees arising out of, directly or indirectly, any claim of personal injury or death associated with such unintended or unauthorized use, even if such claim alleges that SCILLC was negligent regarding the design or manufacture of the part. SCILLC is an Equal Opportunity/Affirmative Action Employer. This literature is subject to all applicable copyright laws and is not for resale in any manner.

### PUBLICATION ORDERING INFORMATION

**LITERATURE FULFILLMENT:**  
Literature Distribution Center for ON Semiconductor  
19521 E. 32nd Pkwy, Aurora, Colorado 80011 USA  
**Phone:** 303-675-2175 or 800-344-3860 Toll Free USA/Canada  
**Fax:** 303-675-2176 or 800-344-3867 Toll Free USA/Canada  
**Email:** [orderlit@onsemi.com](mailto:orderlit@onsemi.com)

**N. American Technical Support:** 800-282-9855 Toll Free  
USA/Canada  
**Europe, Middle East and Africa Technical Support:**  
Phone: 421 33 790 2910  
**Japan Customer Focus Center**  
Phone: 81-3-5817-1050

**ON Semiconductor Website:** [www.onsemi.com](http://www.onsemi.com)  
**Order Literature:** <http://www.onsemi.com/orderlit>  
For additional information, please contact your local  
Sales Representative