



Is Now Part of



**ON Semiconductor®**

To learn more about ON Semiconductor, please visit our website at  
[www.onsemi.com](http://www.onsemi.com)

Please note: As part of the Fairchild Semiconductor integration, some of the Fairchild orderable part numbers will need to change in order to meet ON Semiconductor's system requirements. Since the ON Semiconductor product management systems do not have the ability to manage part nomenclature that utilizes an underscore (\_), the underscore (\_) in the Fairchild part numbers will be changed to a dash (-). This document may contain device numbers with an underscore (\_). Please check the ON Semiconductor website to verify the updated device numbers. The most current and up-to-date ordering information can be found at [www.onsemi.com](http://www.onsemi.com). Please email any questions regarding the system integration to [Fairchild\\_questions@onsemi.com](mailto:Fairchild_questions@onsemi.com).

ON Semiconductor and the ON Semiconductor logo are trademarks of Semiconductor Components Industries, LLC dba ON Semiconductor or its subsidiaries in the United States and/or other countries. ON Semiconductor owns the rights to a number of patents, trademarks, copyrights, trade secrets, and other intellectual property. A listing of ON Semiconductor's product/patent coverage may be accessed at [www.onsemi.com/site/pdf/Patent-Marking.pdf](http://www.onsemi.com/site/pdf/Patent-Marking.pdf). ON Semiconductor reserves the right to make changes without further notice to any products herein. ON Semiconductor makes no warranty, representation or guarantee regarding the suitability of its products for any particular purpose, nor does ON Semiconductor assume any liability arising out of the application or use of any product or circuit, and specifically disclaims any and all liability, including without limitation special, consequential or incidental damages. Buyer is responsible for its products and applications using ON Semiconductor products, including compliance with all laws, regulations and safety requirements or standards, regardless of any support or applications information provided by ON Semiconductor. "Typical" parameters which may be provided in ON Semiconductor data sheets and/or specifications can and do vary in different applications and actual performance may vary over time. All operating parameters, including "Typicals" must be validated for each customer application by customer's technical experts. ON Semiconductor does not convey any license under its patent rights nor the rights of others. ON Semiconductor products are not designed, intended, or authorized for use as a critical component in life support systems or any FDA Class 3 medical devices or medical devices with a same or similar classification in a foreign jurisdiction or any devices intended for implantation in the human body. Should Buyer purchase or use ON Semiconductor products for any such unintended or unauthorized application, Buyer shall indemnify and hold ON Semiconductor and its officers, employees, subsidiaries, affiliates, and distributors harmless against all claims, costs, damages, and expenses, and reasonable attorney fees arising out of, directly or indirectly, any claim of personal injury or death associated with such unintended or unauthorized use, even if such claim alleges that ON Semiconductor was negligent regarding the design or manufacture of the part. ON Semiconductor is an Equal Opportunity/Affirmative Action Employer. This literature is subject to all applicable copyright laws and is not for resale in any manner.



# FFP08S60S 8 A, 600 V, STEALTH™ II Diode

## Features

- Stealth Recovery  $t_{rr} = 30$  ns (@  $I_F = 8$  A)
- Max Forward Voltage,  $V_F = 2.6$  V (@  $T_C = 25^\circ\text{C}$ )
- 600 V Reverse Voltage and High Reliability
- Avalanche Energy Rated
- RoHS Compliant

## Description

The FFP08S60S is a STEALTH™ II diode with soft recovery characteristics. It is silicon nitride passivated ion-implanted epitaxial planar construction.

This device is intended for use as freewheeling or boost diode in switching power supplies and other power switching applications. Their low stored charge and hyperfast soft recovery minimize ringing and electrical noise in many power switching circuits reducing power loss in the switching transistors.

## Applications

- General Purpose
- SMPS, Power Switching Circuits
- Boost Diode in Continuous Mode Power Factor Corrections

## Pin Assignments

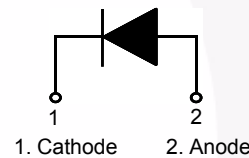
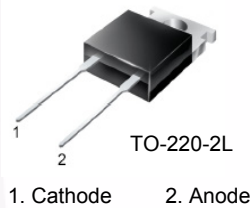

## Absolute Maximum Ratings

Symbol	Parameter	Rating	Unit
$V_{RRM}$	Peak Repetitive Reverse Voltage	600	V
$V_{RWM}$	Working Peak Reverse Voltage	600	V
$V_R$	DC Blocking Voltage	600	V
$I_{F(AV)}$	Average Rectified Forward Current @ $T_C = 115^\circ\text{C}$	8	A
$I_{FSM}$	Non-repetitive Peak Surge Current 60Hz Single Half-Sine Wave	80	A
$T_J, T_{STG}$	Operating Junction and Storage Temperature	- 65 to +175	$^\circ\text{C}$

## Thermal Characteristics $T_C = 25^\circ\text{C}$ unless otherwise noted

Symbol	Parameter	Max.	Unit
$R_{\theta JC}$	Maximum Thermal Resistance, Junction to Case	2.5	$^\circ\text{C/W}$

## Package Marking and Ordering Information

Part Number	Top Mark	Package	Packing Method	Reel Size	Tape Width	Quantity
FFP08S60STU	F08S60S	TO-220-2L	Tube	N/A	N/A	50

**Electrical Characteristics**  $T_C = 25^\circ\text{C}$  unless otherwise noted

Parameter	Conditions		Min.	Typ.	Max.	Unit
$V_F^1$	$I_F = 8\text{ A}$	$T_C = 25^\circ\text{C}$	-	2.1	2.6	V
	$I_F = 8\text{ A}$	$T_C = 125^\circ\text{C}$	-	1.6	-	V
$I_R^1$	$V_R = 600\text{ V}$	$T_C = 25^\circ\text{C}$	-	-	100	$\mu\text{A}$
	$V_R = 600\text{ V}$	$T_C = 125^\circ\text{C}$	-	-	500	$\mu\text{A}$
$t_{rr}$	$I_F = 1\text{ A}$ , $di_F/dt = 100\text{ A}/\mu\text{s}$ , $V_R = 30\text{ V}$	$T_C = 25^\circ\text{C}$	-	-	25	ns
$t_{rr}$	$I_F = 8\text{ A}$ , $di_F/dt = 200\text{ A}/\mu\text{s}$ , $V_R = 390\text{ V}$	$T_C = 25^\circ\text{C}$	-	19	30	ns
$I_{rr}$			-	2.2	-	A
S factor			-	0.6	-	-
$Q_{rr}$			-	21	-	nC
$t_{rr}$	$I_F = 8\text{ A}$ , $di_F/dt = 200\text{ A}/\mu\text{s}$ , $V_R = 390\text{ V}$	$T_C = 125^\circ\text{C}$	-	58	-	ns
$I_{rr}$			-	4.3	-	A
S factor			-	1.3	-	-
$Q_{rr}$			-	125	-	nC
$W_{AVL}$	Avalanche Energy ( $L = 40\text{ mH}$ )		20	-	-	mJ

**Notes:**

1. Pulse : Test Pulse width =  $300\mu\text{s}$ , Duty Cycle = 2%

**Test Circuit and Waveforms**

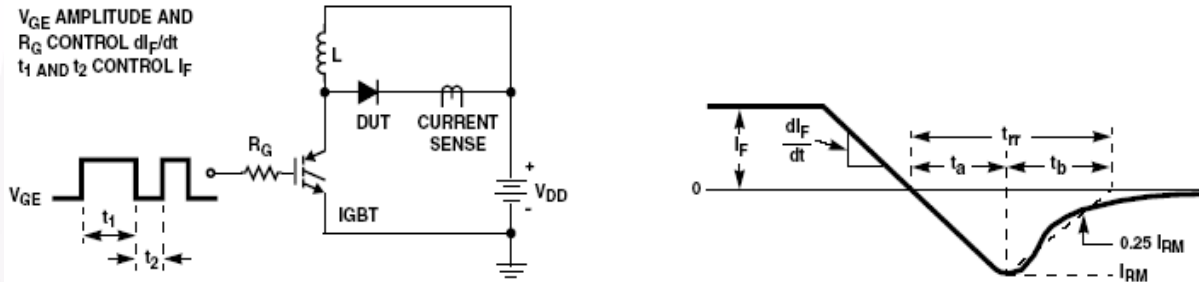

**Figure 1. Diode Reverse Recovery Test Circuit & Waveform**

$L = 40\text{mH}$   
 $R < 0.1\Omega$   
 $V_{DD} = 50\text{V}$

$E_{AVL} = 1/2LI^2 [V_{R(AVL)}/(V_{R(AVL)} - V_{DD})]$   
 $Q1 = \text{IGBT } (BV_{CES} > \text{DUT } V_{R(AVL)})$

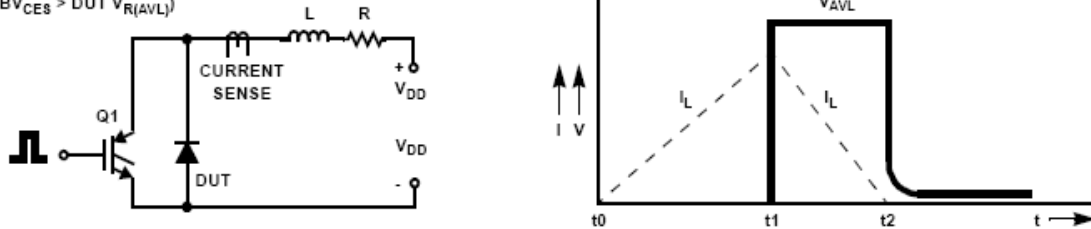

**Figure 2. Unclamped Inductive Switching Test Circuit & Waveform**

Typical Performance Characteristics  $T_c = 25^\circ\text{C}$  unless otherwise noted

Figure 3. Typical Forward Voltage Drop

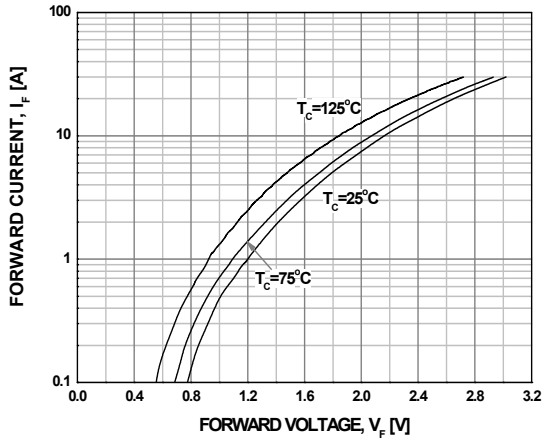

Figure 4. Typical Reverse Current

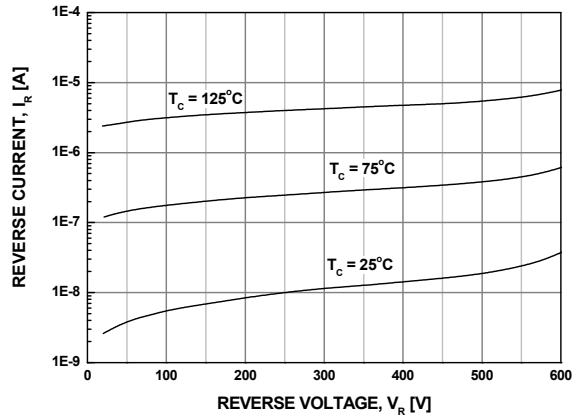

Figure 5. Typical Junction Capacitance

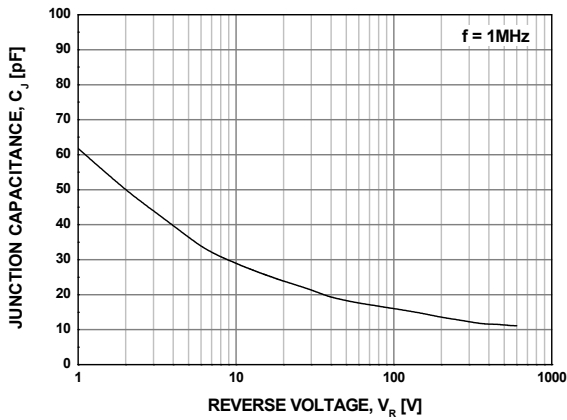

Figure 6. Typical Reverse Recovery Time

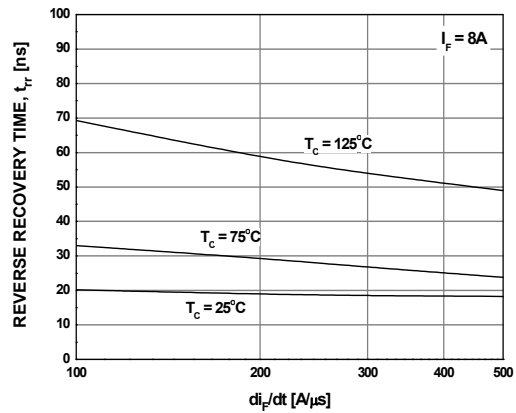

Figure 7. Typical Reverse Recovery Current

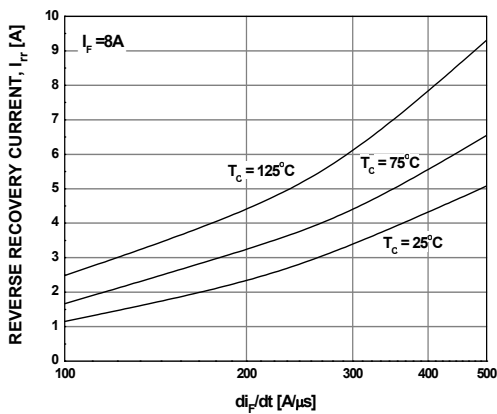
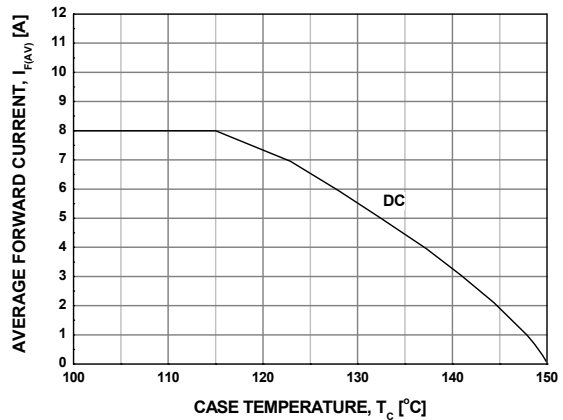
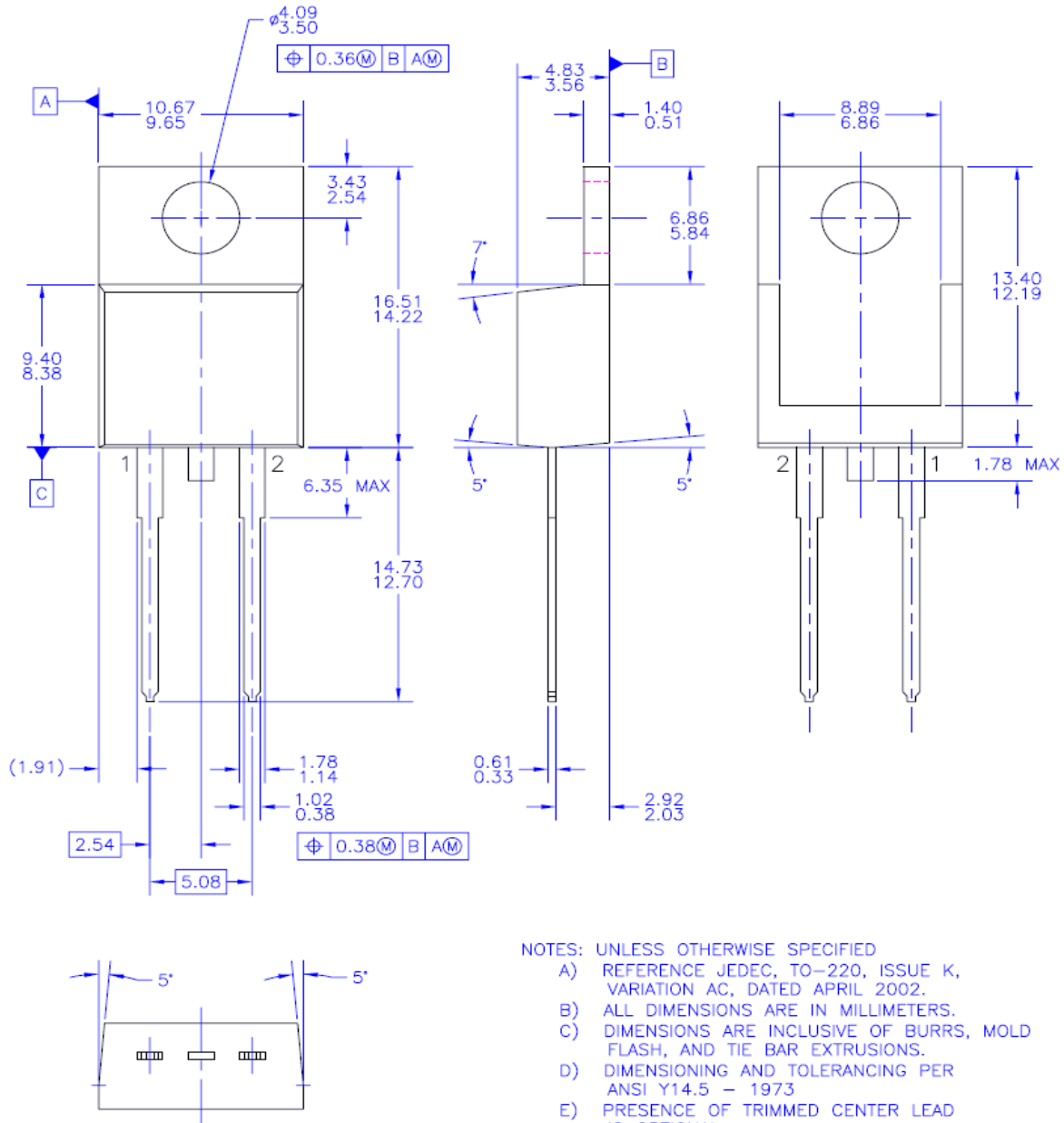

Figure 8. Forward Current Deration Curve



**Mechanical Dimensions**



**Figure 9. TO-220 2L - 2LD, TO220, JEDEC TO-220 VARIATION AC**

Package drawings are provided as a service to customers considering Fairchild components. Drawings may change in any manner without notice. Please note the revision and/or date on the drawing and contact a Fairchild Semiconductor representative to verify or obtain the most recent revision. Package specifications do not expand the terms of Fairchild's worldwide terms and conditions, specifically the warranty therein, which covers Fairchild products.

Always visit Fairchild Semiconductor's online packaging area for the most recent package drawings:

[http://www.fairchildsemi.com/package/packageDetails.html?id=PN\\_TT220-0B2](http://www.fairchildsemi.com/package/packageDetails.html?id=PN_TT220-0B2)



**TRADEMARKS**

The following includes registered and unregistered trademarks and service marks, owned by Fairchild Semiconductor and/or its global subsidiaries, and is not intended to be an exhaustive list of all such trademarks.

- |                          |                         |   |                  |
|--------------------------|-------------------------|---|------------------|
| AccuPower™               | F-PFS™                  | PowerTrench®                                    | SYSTEM GENERAL®  |
| Awinda®                  | FRFET®                  | PowerXS™  | TinyBoost®       |
| AX-CAP®*                 | Global Power ResourceSM | Programmable Active Droop™                      | TinyBuck®        |
| BitSiC™                  | GreenBridge™            | QFET®   | TinyCalc™        |
| Build it Now™            | Green FPS™              | QS™   | TinyLogic®       |
| CorePLUS™                | Green FPS™ e-Series™    | Quiet Series™                                   | TINYOPTO™        |
| CorePOWER™               | Gmax™                   | RapidConfigure™                                 | TinyPower™       |
| CROSSVOLT™               | GTO™                    | IntelliMAX™                                     | TinyPWM™         |
| CTL™                     | ISOPLANAR™              | Marking Small Speakers Sound Louder and Better™ | TinyWire™        |
| Current Transfer Logic™  | MegaBuck™               | MICROCOUPLER™                                   | TranSiC™         |
| DEUXPEED®                | MicroFET™               | MicroPak™                                       | TriFault Detect™ |
| Dual Cool™               | MicroPak2™              | MillerDrive™                                    | TRUECURRENT®*    |
| EcoSPARK®                | MotionMax™              | MotionGrid®                                     | μSerDes™         |
| EfficientMax™            | MTI®                    | MTx®  | UHC®             |
| ESBC™                    | MTx®                    | MVN®  | Ultra FRFET™     |
| F <sup>®</sup>           | mWSaver®                | OptoHiT™  | UniFET™          |
| Fairchild®               | OptoHiT™                | PowerTrench®                                    | VCX™             |
| Fairchild Semiconductor® | PowerTrench®            | PowerXS™  | VisualMax™       |
| FACT Quiet Series™       | PowerXS™                | Programmable Active Droop™                      | VoltagePlus™     |
| FACT®                    | PowerXS™                | QFET®   | XS™              |
| FAST®                    | PowerXS™                | QS™   | Xsens™           |
| FastvCore™               | PowerXS™                | Quiet Series™                                   | 仙童™              |
| FETBench™                | PowerXS™                | RapidConfigure™                                 |                  |
| FPS™                     | PowerXS™                | IntelliMAX™                                     |                  |
|                          | PowerXS™                | ISOPLANAR™                                      |                  |
|                          | PowerXS™                | Marking Small Speakers Sound Louder and Better™ |                  |
|                          | PowerXS™                | MegaBuck™                                       |                  |
|                          | PowerXS™                | MICROCOUPLER™                                   |                  |
|                          | PowerXS™                | MicroFET™                                       |                  |
|                          | PowerXS™                | MicroPak™                                       |                  |
|                          | PowerXS™                | MicroPak2™                                      |                  |
|                          | PowerXS™                | MillerDrive™                                    |                  |
|                          | PowerXS™                | MotionMax™                                      |                  |
|                          | PowerXS™                | MotionGrid®                                     |                  |
|                          | PowerXS™                | MTI®  |                  |
|                          | PowerXS™                | MTx®  |                  |
|                          | PowerXS™                | MVN®  |                  |
|                          | PowerXS™                | mWSaver®  |                  |
|                          | PowerXS™                | OptoHiT™  |                  |
|                          | PowerXS™                | PowerTrench®                                    |                  |
|                          | PowerXS™                | PowerXS™  |                  |
|                          | PowerXS™                | Programmable Active Droop™                      |                  |
|                          | PowerXS™                | QFET®   |                  |
|                          | PowerXS™                | QS™   |                  |
|                          | PowerXS™                | Quiet Series™                                   |                  |
|                          | PowerXS™                | RapidConfigure™                                 |                  |
|                          | PowerXS™                | IntelliMAX™                                     |                  |
|                          | PowerXS™                | ISOPLANAR™                                      |                  |
|                          | PowerXS™                | Marking Small Speakers Sound Louder and Better™ |                  |
|                          | PowerXS™                | MegaBuck™                                       |                  |
|                          | PowerXS™                | MICROCOUPLER™                                   |                  |
|                          | PowerXS™                | MicroFET™                                       |                  |
|                          | PowerXS™                | MicroPak™                                       |                  |
|                          | PowerXS™                | MicroPak2™                                      |                  |
|                          | PowerXS™                | MillerDrive™                                    |                  |
|                          | PowerXS™                | MotionMax™                                      |                  |
|                          | PowerXS™                | MotionGrid®                                     |                  |
|                          | PowerXS™                | MTI®  |                  |
|                          | PowerXS™                | MTx®  |                  |
|                          | PowerXS™                | MVN®  |                  |
|                          | PowerXS™                | mWSaver®  |                  |
|                          | PowerXS™                | OptoHiT™  |                  |
|                          | PowerXS™                | PowerTrench®                                    |                  |
|                          | PowerXS™                | PowerXS™  |                  |
|                          | PowerXS™                | Programmable Active Droop™                      |                  |
|                          | PowerXS™                | QFET®   |                  |
|                          | PowerXS™                | QS™   |                  |
|                          | PowerXS™                | Quiet Series™                                   |                  |
|                          | PowerXS™                | RapidConfigure™                                 |                  |
|                          | PowerXS™                | IntelliMAX™                                     |                  |
|                          | PowerXS™                | ISOPLANAR™                                      |                  |
|                          | PowerXS™                | Marking Small Speakers Sound Louder and Better™ |                  |
|                          | PowerXS™                | MegaBuck™                                       |                  |
|                          | PowerXS™                | MICROCOUPLER™                                   |                  |
|                          | PowerXS™                | MicroFET™                                       |                  |
|                          | PowerXS™                | MicroPak™                                       |                  |
|                          | PowerXS™                | MicroPak2™                                      |                  |
|                          | PowerXS™                | MillerDrive™                                    |                  |
|                          | PowerXS™                | MotionMax™                                      |                  |
|                          | PowerXS™                | MotionGrid®                                     |                  |
|                          | PowerXS™                | MTI®  |                  |
|                          | PowerXS™                | MTx®  |                  |
|                          | PowerXS™                | MVN®  |                  |
|                          | PowerXS™                | mWSaver®  |                  |
|                          | PowerXS™                | OptoHiT™  |                  |
|                          | PowerXS™                | PowerTrench®                                    |                  |
|                          | PowerXS™                | PowerXS™  |                  |
|                          | PowerXS™                | Programmable Active Droop™                      |                  |
|                          | PowerXS™                | QFET®   |                  |
|                          | PowerXS™                | QS™   |                  |
|                          | PowerXS™                | Quiet Series™                                   |                  |
|                          | PowerXS™                | RapidConfigure™                                 |                  |
|                          | PowerXS™                | IntelliMAX™                                     |                  |
|                          | PowerXS™                | ISOPLANAR™                                      |                  |
|                          | PowerXS™                | Marking Small Speakers Sound Louder and Better™ |                  |
|                          | PowerXS™                | MegaBuck™                                       |                  |
|                          | PowerXS™                | MICROCOUPLER™                                   |                  |
|                          | PowerXS™                | MicroFET™                                       |                  |
|                          | PowerXS™                | MicroPak™                                       |                  |
|                          | PowerXS™                | MicroPak2™                                      |                  |
|                          | PowerXS™                | MillerDrive™                                    |                  |
|                          | PowerXS™                | MotionMax™                                      |                  |
|                          | PowerXS™                | MotionGrid®                                     |                  |
|                          | PowerXS™                | MTI®  |                  |
|                          | PowerXS™                | MTx®  |                  |
|                          | PowerXS™                | MVN®  |                  |
|                          | PowerXS™                | mWSaver®  |                  |
|                          | PowerXS™                | OptoHiT™  |                  |
|                          | PowerXS™                | PowerTrench®                                    |                  |
|                          | PowerXS™                | PowerXS™  |                  |
|                          | PowerXS™                | Programmable Active Droop™                      |                  |
|                          | PowerXS™                | QFET®   |                  |
|                          | PowerXS™                | QS™   |                  |
|                          | PowerXS™                | Quiet Series™                                   |                  |
|                          | PowerXS™                | RapidConfigure™                                 |                  |
|                          | PowerXS™                | IntelliMAX™                                     |                  |
|                          | PowerXS™                | ISOPLANAR™                                      |                  |
|                          | PowerXS™                | Marking Small Speakers Sound Louder and Better™ |                  |
|                          | PowerXS™                | MegaBuck™                                       |                  |
|                          | PowerXS™                | MICROCOUPLER™                                   |                  |
|                          | PowerXS™                | MicroFET™                                       |                  |
|                          | PowerXS™                | MicroPak™                                       |                  |
|                          | PowerXS™                | MicroPak2™                                      |                  |
|                          | PowerXS™                | MillerDrive™                                    |                  |
|                          | PowerXS™                | MotionMax™                                      |                  |
|                          | PowerXS™                | MotionGrid®                                     |                  |
|                          | PowerXS™                | MTI®  |                  |
|                          | PowerXS™                | MTx®  |                  |
|                          | PowerXS™                | MVN®  |                  |
|                          | PowerXS™                | mWSaver®  |                  |
|                          | PowerXS™                | OptoHiT™  |                  |
|                          | PowerXS™                | PowerTrench®                                    |                  |
|                          | PowerXS™                | PowerXS™  |                  |
|                          | PowerXS™                | Programmable Active Droop™                      |                  |
|                          | PowerXS™                | QFET®   |                  |
|                          | PowerXS™                | QS™   |                  |
|                          | PowerXS™                | Quiet Series™                                   |                  |
|                          | PowerXS™                | RapidConfigure™                                 |                  |
|                          | PowerXS™                | IntelliMAX™                                     |                  |
|                          | PowerXS™                | ISOPLANAR™                                      |                  |
|                          | PowerXS™                | Marking Small Speakers Sound Louder and Better™ |                  |
|                          | PowerXS™                | MegaBuck™                                       |                  |
|                          | PowerXS™                | MICROCOUPLER™                                   |                  |
|                          | PowerXS™                | MicroFET™                                       |                  |
|                          | PowerXS™                | MicroPak™                                       |                  |
|                          | PowerXS™                | MicroPak2™                                      |                  |
|                          | PowerXS™                | MillerDrive™                                    |                  |
|                          | PowerXS™                | MotionMax™                                      |                  |
|                          | PowerXS™                | MotionGrid®                                     |                  |
|                          | PowerXS™                | MTI®  |                  |
|                          | PowerXS™                | MTx®  |                  |
|                          | PowerXS™                | MVN®  |                  |
|                          | PowerXS™                | mWSaver®  |                  |
|                          | PowerXS™                | OptoHiT™  |                  |
|                          | PowerXS™                | PowerTrench®                                    |                  |
|                          | PowerXS™                | PowerXS™  |                  |
|                          | PowerXS™                | Programmable Active Droop™                      |                  |
|                          | PowerXS™                | QFET®   |                  |
|                          | PowerXS™                | QS™   |                  |
|                          | PowerXS™                | Quiet Series™                                   |                  |
|                          | PowerXS™                | RapidConfigure™                                 |                  |
|                          | PowerXS™                | IntelliMAX™                                     |                  |
|                          | PowerXS™                | ISOPLANAR™                                      |                  |
|                          | PowerXS™                | Marking Small Speakers Sound Louder and Better™ |                  |
|                          | PowerXS™                | MegaBuck™                                       |                  |
|                          | PowerXS™                | MICROCOUPLER™                                   |                  |
|                          | PowerXS™                | MicroFET™                                       |                  |
|                          | PowerXS™                | MicroPak™                                       |                  |
|                          | PowerXS™                | MicroPak2™                                      |                  |
|                          | PowerXS™                | MillerDrive™                                    |                  |
|                          | PowerXS™                | MotionMax™                                      |                  |
|                          | PowerXS™                | MotionGrid®                                     |                  |
|                          | PowerXS™                | MTI®  |                  |
|                          | PowerXS™                | MTx®  |                  |
|                          | PowerXS™                | MVN®  |                  |
|                          | PowerXS™                | mWSaver®  |                  |
|                          | PowerXS™                | OptoHiT™  |                  |
|                          | PowerXS™                | PowerTrench®                                    |                  |
|                          | PowerXS™                | PowerXS™  |                  |
|                          | PowerXS™                | Programmable Active Droop™                      |                  |
|                          | PowerXS™                | QFET®   |                  |
|                          | PowerXS™                | QS™   |                  |
|                          | PowerXS™                | Quiet Series™                                   |                  |
|                          | PowerXS™                | RapidConfigure™                                 |                  |
|                          | PowerXS™                | IntelliMAX™                                     |                  |
|                          | PowerXS™                | ISOPLANAR™                                      |                  |
|                          | PowerXS™                | Marking Small Speakers Sound Louder and Better™ |                  |
|                          | PowerXS™                | MegaBuck™                                       |                  |
|                          | PowerXS™                | MICROCOUPLER™                                   |                  |
|                          | PowerXS™                | MicroFET™                                       |                  |
|                          | PowerXS™                | MicroPak™                                       |                  |
|                          | PowerXS™                | MicroPak2™                                      |                  |
|                          | PowerXS™                | MillerDrive™                                    |                  |
|                          | PowerXS™                | MotionMax™                                      |                  |
|                          | PowerXS™                | MotionGrid®                                     |                  |
|                          | PowerXS™                | MTI®  |                  |
|                          | PowerXS™                | MTx®  |                  |
|                          | PowerXS™                | MVN®  |                  |
|                          | PowerXS™                | mWSaver®  |                  |
|                          | PowerXS™                | OptoHiT™  |                  |
|                          | PowerXS™                | PowerTrench®                                    |                  |
|                          | PowerXS™                | PowerXS™  |                  |
|                          | PowerXS™                | Programmable Active Droop™                      |                  |
|                          | PowerXS™                | QFET®   |                  |
|                          | PowerXS™                | QS™   |                  |
|                          | PowerXS™                | Quiet Series™                                   |                  |
|                          | PowerXS™                | RapidConfigure™                                 |                  |
|                          | PowerXS™                | IntelliMAX™                                     |                  |
|                          | PowerXS™                | ISOPLANAR™                                      |                  |
|                          | PowerXS™                | Marking Small Speakers Sound Louder and Better™ |                  |
|                          | PowerXS™                | MegaBuck™                                       |                  |
|                          | PowerXS™                | MICROCOUPLER™                                   |                  |
|                          | PowerXS™                | MicroFET™                                       |                  |
|                          | PowerXS™                | MicroPak™                                       |                  |
|                          | PowerXS™                | MicroPak2™                                      |                  |
|                          | PowerXS™                | MillerDrive™                                    |                  |
|                          | PowerXS™                | MotionMax™                                      |                  |
|                          | PowerXS™                | MotionGrid®                                     |                  |
|                          | PowerXS™                | MTI®  |                  |
|                          | PowerXS™                | MTx®  |                  |
|                          | PowerXS™                | MVN®  |                  |
|                          | PowerXS™                | mWSaver®  |                  |
|                          | PowerXS™                | OptoHiT™  |                  |
|                          | PowerXS™                | PowerTrench®                                    |                  |
|                          | PowerXS™                | PowerXS™  |                  |
|                          | PowerXS™                | Programmable Active Droop™                      |                  |
|                          | PowerXS™                | QFET®   |                  |
|                          | PowerXS™                | QS™   |                  |
|                          | PowerXS™                | Quiet Series™                                   |                  |
|                          | PowerXS™                | RapidConfigure™                                 |                  |
|                          | PowerXS™                | IntelliMAX™                                     |                  |
|                          | PowerXS™                | ISOPLANAR™                                      |                  |
|                          | PowerXS™                | Marking Small Speakers Sound Louder and Better™ |                  |
|                          | PowerXS™                | MegaBuck™                                       |                  |
|                          | PowerXS™                | MICROCOUPLER™                                   |                  |
|                          | PowerXS™                | MicroFET™                                       |                  |
|                          | PowerXS™                | MicroPak™                                       |                  |
|                          | PowerXS™                | MicroPak2™                                      |                  |
|                          | PowerXS™                | MillerDrive™                                    |                  |
|                          | PowerXS™                | MotionMax™                                      |                  |
|                          | PowerXS™                | MotionGrid®                                     |                  |
|                          | PowerXS™                | MTI®  |                  |
|                          | PowerXS™                | MTx®  |                  |
|                          | PowerXS™                | MVN®  |                  |
|                          | PowerXS™                | mWSaver®  |                  |
|                          | PowerXS™                | OptoHiT™  |                  |
|                          | PowerXS™                | PowerTrench®                                    |                  |
|                          | PowerXS™                | PowerXS™  |                  |
|                          | PowerXS™                | Programmable Active Droop™                      |                  |
|                          | PowerXS™                | QFET®   |                  |
|                          | PowerXS™                | QS™   |                  |
|                          | PowerXS™                | Quiet Series™                                   |                  |
|                          | PowerXS™                | RapidConfigure™                                 |                  |
|                          | PowerXS™                | IntelliMAX™                                     |                  |
|                          | PowerXS™                | ISOPLANAR™                                      |                  |
|                          | PowerXS™                | Marking Small Speakers Sound Louder and Better™ |                  |
|                          | PowerXS™                | MegaBuck™                                       |                  |
|                          | PowerXS™                | MICROCOUPLER™                                   |                  |
|                          | PowerXS™                | MicroFET™                                       |                  |
|                          | PowerXS™                | MicroPak™                                       |                  |
|                          | PowerXS™                | MicroPak2™                                      |                  |
|                          | PowerXS™                | MillerDrive™                                    |                  |
|                          | PowerXS™                | MotionMax™                                      |                  |
|                          | PowerXS™                | MotionGrid®                                     |                  |
|                          | PowerXS™                | MTI®  |                  |
|                          | PowerXS™                | MTx®  |                  |
|                          | PowerXS™                | MVN®  |                  |
|                          | PowerXS™                | mWSaver®  |                  |
|                          | PowerXS™                | OptoHiT™  |                  |
|                          | PowerXS™                | PowerTrench®                                    |                  |
|                          | PowerXS™                | PowerXS™  |                  |
|                          | PowerXS™                | Programmable Active Droop™                      |                  |
|                          | PowerXS™                | QFET®   |                  |
|                          | PowerXS™                | QS™   |                  |
|                          | PowerXS™                | Quiet Series™                                   |                  |
|                          | PowerXS™                | RapidConfigure™                                 |                  |
|                          | PowerXS™                | IntelliMAX™                                     |                  |
|                          | PowerXS™                | ISOPLANAR™                                      |                  |
|                          | PowerXS™                | Marking Small Speakers Sound Louder and Better™ |                  |
|                          | PowerXS™                | MegaBuck™                                       |                  |
|                          | PowerXS™                | MICROCOUPLER™                                   |                  |
|                          | PowerXS™                | MicroFET™                                       |                  |
|                          | PowerXS™                | MicroPak™                                       |                  |
|                          | PowerXS™                | MicroPak2™                                      |                  |
|                          | PowerXS™                | MillerDrive™                                    |                  |
|                          | PowerXS™                | MotionMax™                                      |                  |
|                          | PowerXS™                | MotionGrid®                                     |                  |
|                          | PowerXS™                | MTI®  |                  |
|                          | PowerXS™                | MTx®  |                  |
|                          | PowerXS™                | MVN®  |                  |
|                          | PowerXS™                | mWSaver®  |                  |
|                          | PowerXS™                | OptoHiT™  |                  |
|                          | PowerXS™                | PowerTrench®                                    |                  |
|                          | PowerXS™                | PowerXS™  |                  |
|                          | PowerXS™                | Programmable Active Droop™                      |                  |
|                          | PowerXS™                | QFET®   |                  |
|                          | PowerXS™                | QS™   |                  |
|                          | PowerXS™                | Quiet Series™                                   |                  |
|                          | PowerXS™                | RapidConfigure™                                 |                  |
|                          | PowerXS™                | IntelliMAX™                                     |                  |
|                          | PowerXS™                | ISOPLANAR™                                      |                  |
|                          | PowerXS™                | Marking Small Speakers Sound Louder and Better™ |                  |
|                          | PowerXS™                | MegaBuck™                                       |                  |
|                          | PowerXS™                | MICROCOUPLER™                                   |                  |
|                          | PowerXS™                | MicroFET™                                       |                  |
|                          | PowerXS™                | MicroPak™                                       |                  |
|                          | PowerXS™                | MicroPak2™                                      |                  |
|                          | PowerXS™                | MillerDrive™                                    |                  |
|                          | PowerXS™                | MotionMax™                                      |                  |
|                          | PowerXS™                | MotionGrid®                                     |                  |
|                          | PowerXS™                | MTI®  |                  |
|                          | PowerXS™                | MTx®  |                  |
|                          | PowerXS™                | MVN®  |                  |
|                          | PowerXS™                | mWSaver®  |                  |
|                          | PowerXS™                | OptoHiT™  |                  |
|                          | PowerXS™                | PowerTrench®                                    |                  |
|                          | PowerXS™                | PowerXS™  |                  |
|                          | PowerXS™                | Programmable Active Droop™                      |                  |
|                          | PowerXS™                | QFET®   |                  |
|                          | PowerXS™                | QS™   |                  |
|                          | PowerXS™                | Quiet Series™                                   |                  |
|                          | PowerXS™                | RapidConfigure™                                 |                  |
|                          | PowerXS™                | IntelliMAX™                                     |                  |
|                          | PowerXS™                | ISOPLANAR™                                      |                  |
|                          | PowerXS™                | Marking Small Speakers Sound Louder and Better™ |                  |
|                          | PowerXS™                | MegaBuck™                                       |                  |
|                          | PowerXS™                | MICROCOUPLER™                                   |                  |
|                          | PowerXS™                | MicroFET™                                       |                  |
|                          | PowerXS™                | MicroPak™                                       |                  |
|                          | PowerXS™                | MicroPak2™                                      |                  |

ON Semiconductor and  are trademarks of Semiconductor Components Industries, LLC dba ON Semiconductor or its subsidiaries in the United States and/or other countries. ON Semiconductor owns the rights to a number of patents, trademarks, copyrights, trade secrets, and other intellectual property. A listing of ON Semiconductor's product/patent coverage may be accessed at [www.onsemi.com/site/pdf/Patent-Marking.pdf](http://www.onsemi.com/site/pdf/Patent-Marking.pdf). ON Semiconductor reserves the right to make changes without further notice to any products herein. ON Semiconductor makes no warranty, representation or guarantee regarding the suitability of its products for any particular purpose, nor does ON Semiconductor assume any liability arising out of the application or use of any product or circuit, and specifically disclaims any and all liability, including without limitation special, consequential or incidental damages. Buyer is responsible for its products and applications using ON Semiconductor products, including compliance with all laws, regulations and safety requirements or standards, regardless of any support or applications information provided by ON Semiconductor. "Typical" parameters which may be provided in ON Semiconductor data sheets and/or specifications can and do vary in different applications and actual performance may vary over time. All operating parameters, including "Typicals" must be validated for each customer application by customer's technical experts. ON Semiconductor does not convey any license under its patent rights nor the rights of others. ON Semiconductor products are not designed, intended, or authorized for use as a critical component in life support systems or any FDA Class 3 medical devices or medical devices with a same or similar classification in a foreign jurisdiction or any devices intended for implantation in the human body. Should Buyer purchase or use ON Semiconductor products for any such unintended or unauthorized application, Buyer shall indemnify and hold ON Semiconductor and its officers, employees, subsidiaries, affiliates, and distributors harmless against all claims, costs, damages, and expenses, and reasonable attorney fees arising out of, directly or indirectly, any claim of personal injury or death associated with such unintended or unauthorized use, even if such claim alleges that ON Semiconductor was negligent regarding the design or manufacture of the part. ON Semiconductor is an Equal Opportunity/Affirmative Action Employer. This literature is subject to all applicable copyright laws and is not for resale in any manner.

## PUBLICATION ORDERING INFORMATION

### LITERATURE FULFILLMENT:

Literature Distribution Center for ON Semiconductor  
19521 E. 32nd Pkwy, Aurora, Colorado 80011 USA  
**Phone:** 303-675-2175 or 800-344-3860 Toll Free USA/Canada  
**Fax:** 303-675-2176 or 800-344-3867 Toll Free USA/Canada  
**Email:** [orderlit@onsemi.com](mailto:orderlit@onsemi.com)

**N. American Technical Support:** 800-282-9855 Toll Free  
USA/Canada  
**Europe, Middle East and Africa Technical Support:**  
Phone: 421 33 790 2910  
**Japan Customer Focus Center**  
Phone: 81-3-5817-1050

**ON Semiconductor Website:** [www.onsemi.com](http://www.onsemi.com)  
**Order Literature:** <http://www.onsemi.com/orderlit>  
For additional information, please contact your local  
Sales Representative