



Surface Mount Schottky Barrier Rectifier		Reverse Voltage - 60 V Forward Current -2.0A							
<p style="text-align: center;"><u>SOD-123FL</u></p> <div style="display: flex; align-items: center; justify-content: center;"> 1  2  </div> <table border="1" style="margin-top: 10px; width: 100%;"> <thead> <tr> <th>PIN</th> <th>DESCRIPTION</th> </tr> </thead> <tbody> <tr> <td>1</td> <td>Cathode</td> </tr> <tr> <td>2</td> <td>Anode</td> </tr> </tbody> </table>		PIN	DESCRIPTION	1	Cathode	2	Anode	<h3>Features</h3> <ul style="list-style-type: none"> • Metal silicon junction, majority carrier conduction • For surface mounted applications • Low power loss, high efficiency • High forward surge current capability • For use in low voltage, high frequency inverters, free wheeling, and polarity protection applications <h3>Mechanical Data</h3> <ul style="list-style-type: none"> • Case: SOD-123FL • Terminals: Solderable per MIL-STD-750, Method 2026 • Approx. Weight: 15mg 0.00048oz 	
PIN	DESCRIPTION								
1	Cathode								
2	Anode								
<p>Absolute Maximum Ratings and Electrical characteristics</p> <p>Ratings at 25 °C ambient temperature unless otherwise specified. Single phase, half wave, 60Hz resistive or inductive load, for capacitive load, derate by 20 %</p>									
Parameter	Symbols	RB060M-60	Units						
Maximum Repetitive Peak Reverse Voltage	V_{RRM}	60	V						
Maximum RMS voltage	V_{RMS}	42	V						
Maximum DC Blocking Voltage	V_{DC}	60	V						
Maximum Average Forward Rectified Current	$I_{F(AV)}$	2.0	A						
Peak Forward Surge Current, 8.3ms Single Half Sine-wave Superimposed on Rated Load (JEDEC method)	I_{FSM}	50	A						
Max Instantaneous Forward Voltage at 2 A	V_F	0.70	V						
Maximum DC Reverse Current $T_a = 25^{\circ}C$ at Rated DC Reverse Voltage $T_a = 100^{\circ}C$	I_R	0.5 5	mA						
Typical Junction Capacitance ⁽¹⁾	C_j	80	pF						
Typical Thermal Resistance ⁽²⁾	$R_{\theta JA}$	85	°C/W						
Operating Junction Temperature Range	T_j	-55 ~ +150	°C						
Storage Temperature Range	T_{stg}	-55 ~ +150	°C						
<p>(1) Measured at 1 MHz and applied reverse voltage of 4 V D.C</p> <p>(2) P.C.B. mounted with 2.0" X 2.0" (5 X 5 cm) copper pad areas.</p>									

Fig.1 Forward Current Derating Curve

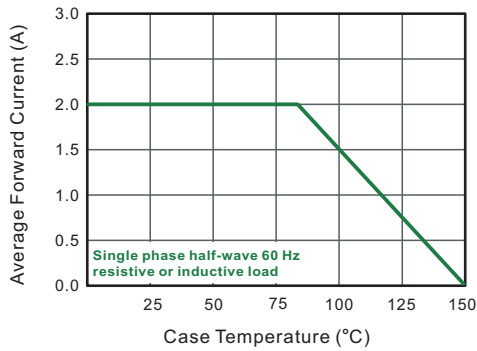

Fig.2 Typical Reverse Characteristics

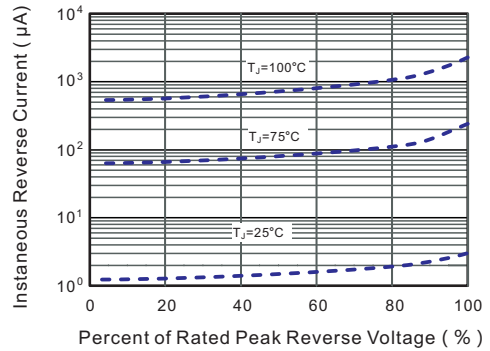

Fig.3 Typical Forward Characteristic

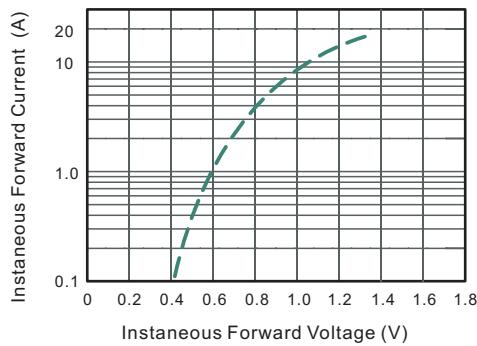

Fig.4 Typical Junction Capacitance

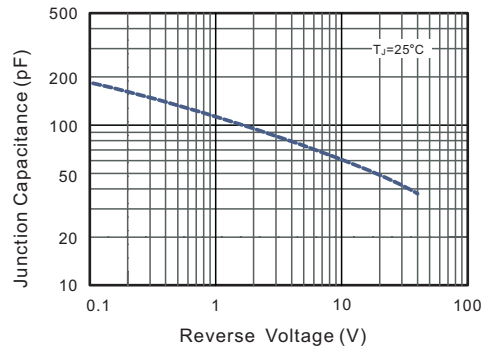

Fig.5 Maximum Non-Repetitive Peak Forward Surge Current

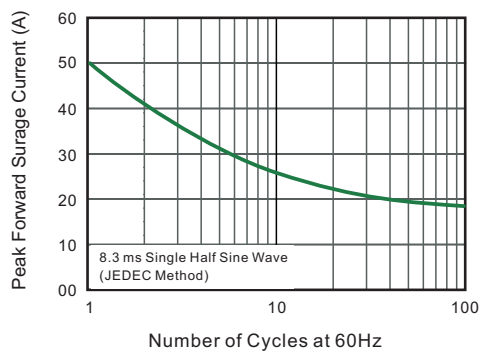
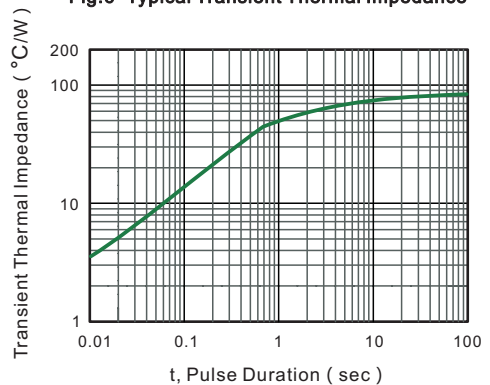

Fig.6- Typical Transient Thermal Impedance



PACKAGE OUTLINE

Plastic surface mounted package; 2 leads

SOD-123FL

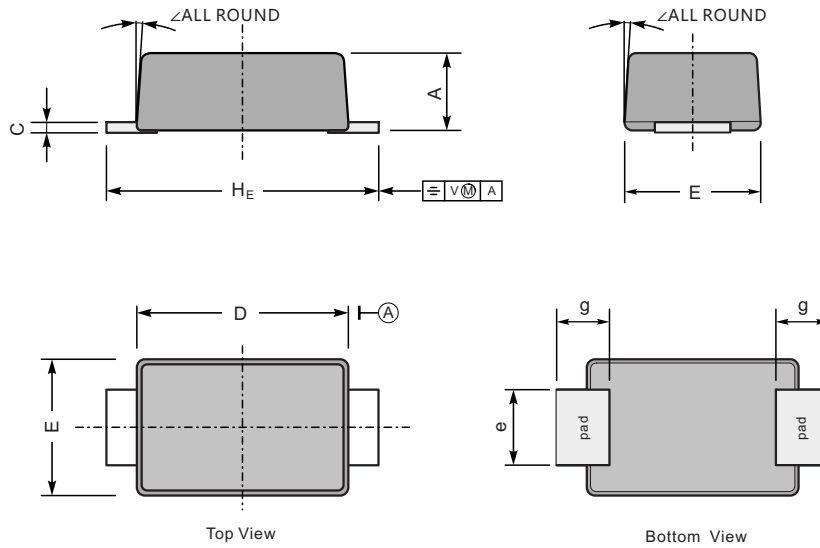

UNIT		A	C	D	E	e	g	H_E	\angle
mm	max	1.1	0.20	2.9	1.9	1.1	0.9	3.8	7°
	min	0.9	0.12	2.6	1.7	0.8	0.7	3.5	
mil	max	43	7.9	114	75	43	35	150	
	min	35	4.7	102	67	31	28	138	

The recommended mounting pad size

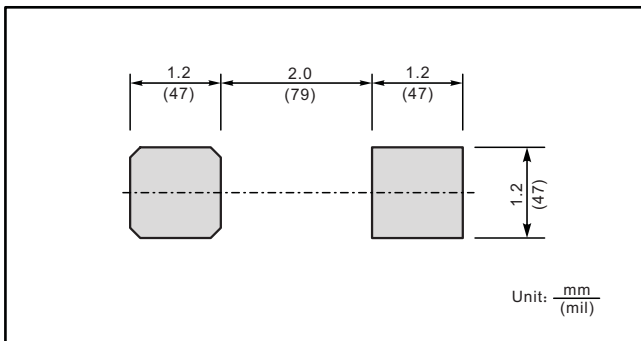

Marking

Type number	Marking code
RB060M-60	37