

Schottky Barrier Diode

30 V, 2 A, Low IR, Single PCP

SB20-03P

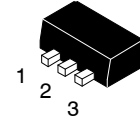

SOT-89 / PCP-1
CASE 419AU

Features

- Low Forward Voltage (V_F max = 0.55 V)
- Fast Reverse Recovery Time (t_{rr} max = 20 ns)
- Low Switching Noise
- Low Leakage Current and High Reliability due to Highly Reliable Planar Structure
- These Devices are Pb-Free and are RoHS Compliant

Applications

- High Frequency Rectification (Switching, Regulators, Converters, Choppers)

SPECIFICATIONS

ABSOLUTE MAXIMUM RATINGS at $T_A = 25^\circ\text{C}$

Parameter	Symbol	Value	Unit
Repetitive Peak Reverse Voltage	V_{RRM}	30	V
Nonrepetitive Peak Reverse Voltage	V_{RSM}	35	V
Average Output Current	I_O	2	A
Surge Forward Current (Note 1)	I_{FSM}	20	A
Junction Temperature	T_J	-55 to +125	$^\circ\text{C}$
Storage Temperature	T_{STG}	-55 to +125	$^\circ\text{C}$

Stresses exceeding those listed in the Maximum Ratings table may damage the device. If any of these limits are exceeded, device functionality should not be assumed, damage may occur and reliability may be affected.

1. Conditions: 50 Hz sine wave, 1 cycle

ELECTRICAL CONNECTION

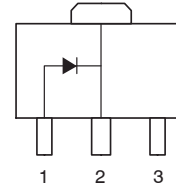

1: Anode
2: Cathode
3: No Contact

PCP

MARKING DIAGRAM

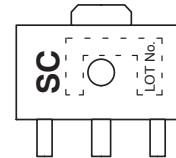

ORDERING INFORMATION

Device	Package	Shipping [†]
SB20-03P-TD-E	PCP (Pb-Free)	1000 / Tape & Reel

[†]For information on tape and reel specifications, including part orientation and tape sizes, please refer to our Tape and Reel Packaging Specifications Brochure, [BRD8011/D](#).

SB20-03P

ELECTRICAL CHARACTERISTICS at $T_A = 25^\circ\text{C}$

Parameter	Symbol	Conditions	Ratings			Unit
			Min	Typ	Max	
Reverse Voltage	V_R	$I_R = 500 \mu\text{A}$	30			V
Forward Voltage	V_F	$I_F = 2 \text{ A}$			0.55	V
Reverse Current	I_R	$V_R = 15 \text{ V}$			100	μA
Interterminal Capacitance	C	$V_R = 10 \text{ V}, f = 1 \text{ MHz}$		70		pF
Reverse Recovery Time	t_{rr}	$I_F = I_R = 100 \text{ mA}$, See specified Test Circuit			20	ns
Thermal Resistance	$R_{th(j-a)1}$			300		$^\circ\text{C/W}$
	$R_{th(j-a)2}$	When mounted on ceramic substrate (250 mm ² x 0.8 mm)		110		$^\circ\text{C/W}$

Product parametric performance is indicated in the Electrical Characteristics for the listed test conditions, unless otherwise noted. Product performance may not be indicated by the Electrical Characteristics if operated under different conditions.

t_{rr} Test Circuit

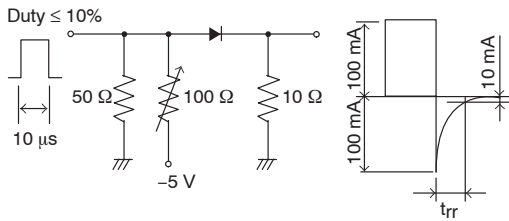

Land Pattern Example

Unit: mm

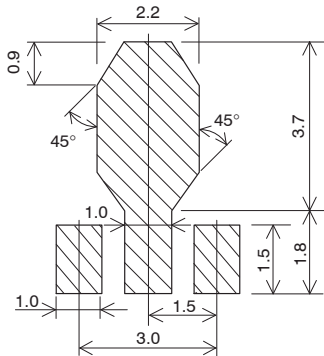

TYPICAL CHARACTERISTICS

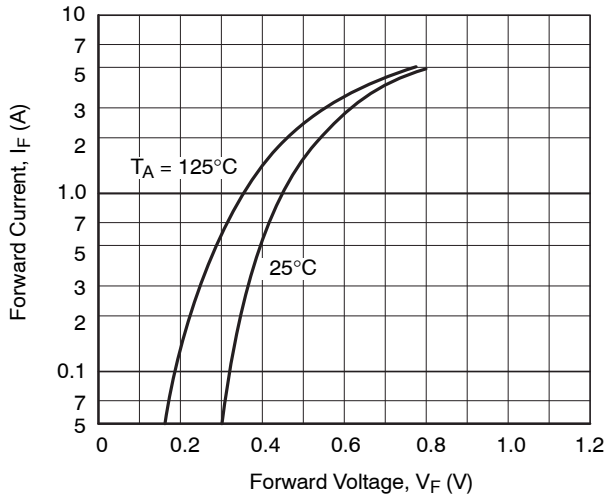

Figure 1. $I_F - V_F$

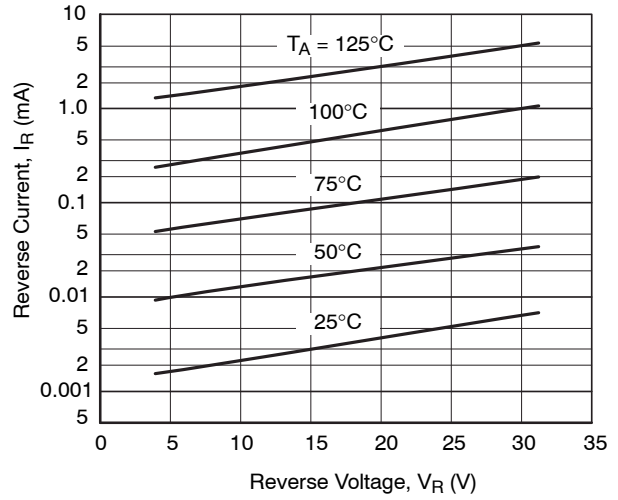

Figure 2. $I_R - V_R$

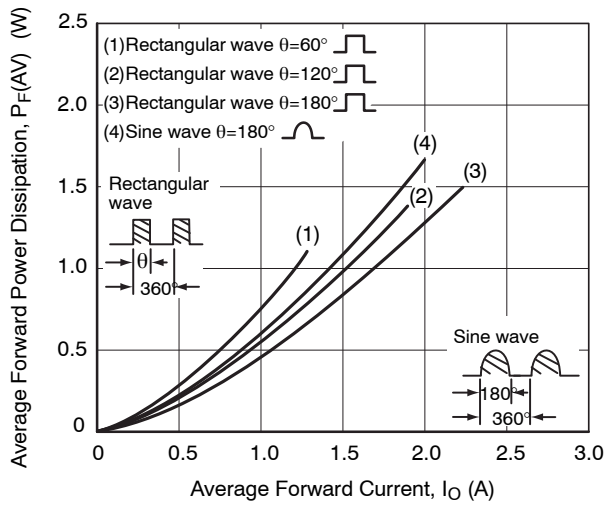

Figure 3. $P_F(AV) - I_O$

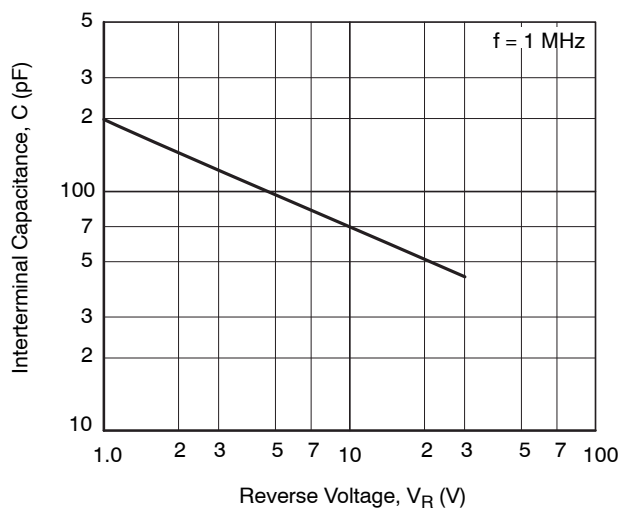

Figure 4. $C - V_R$

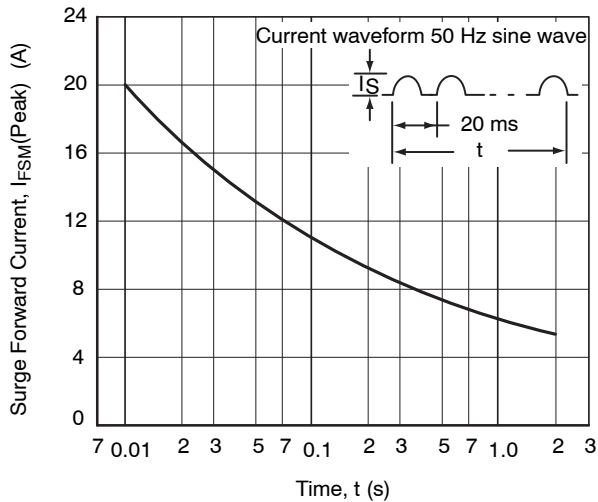

Figure 5. $I_{FSM} - t$

MECHANICAL CASE OUTLINE
PACKAGE DIMENSIONS

ON Semiconductor®



SOT-89 / PCP-1
CASE 419AU
ISSUE O

DATE 30 APR 2012

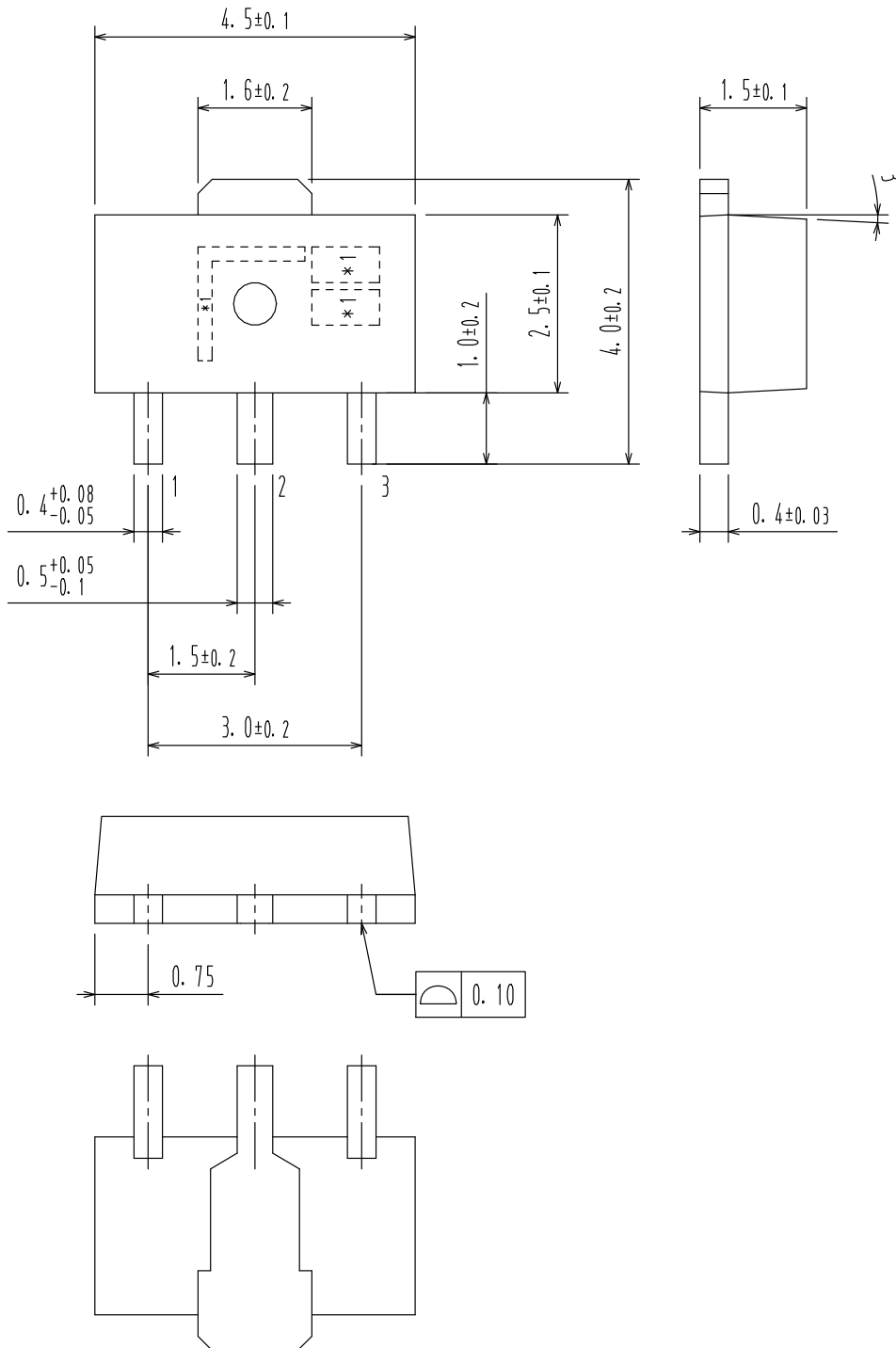

DOCUMENT NUMBER:	98AON79746E	Electronic versions are uncontrolled except when accessed directly from the Document Repository. Printed versions are uncontrolled except when stamped "CONTROLLED COPY" in red.
DESCRIPTION:	SOT-89 / PCP-1	PAGE 1 OF 1

ON Semiconductor and are trademarks of Semiconductor Components Industries, LLC dba ON Semiconductor or its subsidiaries in the United States and/or other countries. ON Semiconductor reserves the right to make changes without further notice to any products herein. ON Semiconductor makes no warranty, representation or guarantee regarding the suitability of its products for any particular purpose, nor does ON Semiconductor assume any liability arising out of the application or use of any product or circuit, and specifically disclaims any and all liability, including without limitation special, consequential or incidental damages. ON Semiconductor does not convey any license under its patent rights nor the rights of others.

onsemi, **Onsemi**, and other names, marks, and brands are registered and/or common law trademarks of Semiconductor Components Industries, LLC dba "**onsemi**" or its affiliates and/or subsidiaries in the United States and/or other countries. **onsemi** owns the rights to a number of patents, trademarks, copyrights, trade secrets, and other intellectual property. A listing of **onsemi**'s product/patent coverage may be accessed at www.onsemi.com/site/pdf/Patent-Marking.pdf. **onsemi** reserves the right to make changes at any time to any products or information herein, without notice. The information herein is provided "as-is" and **onsemi** makes no warranty, representation or guarantee regarding the accuracy of the information, product features, availability, functionality, or suitability of its products for any particular purpose, nor does **onsemi** assume any liability arising out of the application or use of any product or circuit, and specifically disclaims any and all liability, including without limitation special, consequential or incidental damages. Buyer is responsible for its products and applications using **onsemi** products, including compliance with all laws, regulations and safety requirements or standards, regardless of any support or applications information provided by **onsemi**. "Typical" parameters which may be provided in **onsemi** data sheets and/or specifications can and do vary in different applications and actual performance may vary over time. All operating parameters, including "Typicals" must be validated for each customer application by customer's technical experts. **onsemi** does not convey any license under any of its intellectual property rights nor the rights of others. **onsemi** products are not designed, intended, or authorized for use as a critical component in life support systems or any FDA Class 3 medical devices or medical devices with a same or similar classification in a foreign jurisdiction or any devices intended for implantation in the human body. Should Buyer purchase or use **onsemi** products for any such unintended or unauthorized application, Buyer shall indemnify and hold **onsemi** and its officers, employees, subsidiaries, affiliates, and distributors harmless against all claims, costs, damages, and expenses, and reasonable attorney fees arising out of, directly or indirectly, any claim of personal injury or death associated with such unintended or unauthorized use, even if such claim alleges that **onsemi** was negligent regarding the design or manufacture of the part. **onsemi** is an Equal Opportunity/Affirmative Action Employer. This literature is subject to all applicable copyright laws and is not for resale in any manner.

ADDITIONAL INFORMATION

TECHNICAL PUBLICATIONS:

Technical Library: www.onsemi.com/design/resources/technical-documentation
onsemi Website: www.onsemi.com

ONLINE SUPPORT: www.onsemi.com/support

For additional information, please contact your local Sales Representative at www.onsemi.com/support/sales