

# BIF7

## 5-800 MHz Internally Matched IF Amplifier



### Device Features

- OIP3 = 40.0 dBm @ 70 MHz
- Gain = 27.1 dB @ 70 MHz
- Output P1 dB = 21.3 dBm @ 70 MHz
- 50 Ω Cascadable
- Patented temperature compensation
- Patented over voltage protection
- Lead-free/RoHS-compliant SOT-89 SMT package



### Product Description

BeRex's BIF7 is a high performance InGaP/ GaAs HBT MMIC amplifier, internally matched to 50 Ohms and uses a patented **temperature compensation** circuit to provide stable current over the operating temperature range without the need for external components and a patented **over voltage protection** circuit to protect a internal device. The BIF7 is designed for high linearity IF amplifier that requires excellent gain, high OIP3 and flatness. It is packaged in a RoHS-compliant with SOT-89 surface mount package.

### Applications

- Base station Infrastructure/RFID
- Commercial/Industrial/Military wireless system

### Applications Circuit

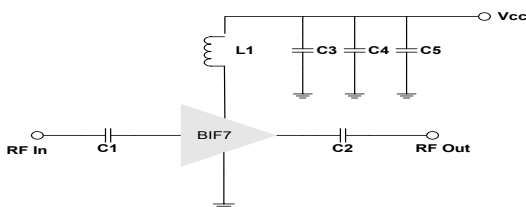

\*C1, C2=100nF ± 5%; C3 = 100 pF ± 5%; C4 = 1000pF ±5%

\*C5 = 10uF; L1 = 1uH ±5%

\*C1, C2 = 100pF; L1 = 12nH ±5% for RF Bandwidth

### Typical Performance<sup>1</sup>

Parameter	Frequency					Unit
	70	140	250	500	800	
Gain	27.1	27.0	26.7	25.7	25.0	dB
S11	-32.0	-41.0	-38.5	-28.6	-23.2	dB
S22	-12.1	-11.6	-10.1	-7.2	-6.5	dB
OIP3 <sup>2</sup>	40.0	38.5	38.0	36.0	32.5	dBm
P1dB	21.3	21.5	21.5	21.0	19.7	dBm
Noise Figure	2.9	2.9	3.0	3.0	3.0	dB

<sup>1</sup> Device performance \_ measured on a BeRex evaluation board at 25°C, 50 Ω system.

<sup>2</sup> OIP3 \_ measured with two tones at an output of 10 dBm per tone separated by 1 MHz.

	Min.	Typical	Max.	Unit
Bandwidth	5		800	MHz
I <sub>c</sub> @ (V <sub>c</sub> = 5V)	85	95	105	mA
V <sub>c</sub>		5.0		V
dG/dT		-0.003		dB/°C
R <sub>TH</sub>		50		°C/W

### Absolute Maximum Ratings

Parameter	Rating	Unit
Operating Case Temperature	-40 to +85	°C
Storage Temperature	-55 to +155	°C
Junction Temperature	+220	°C
Operating Voltage	+6.0	V
Supply Current	160	mA
Input RF Power	23	dBm

Operation of this device above any of these parameters may result in permanent damage.

# BIF7

## 5-800 MHz Internally Matched IF Amplifier



### V-I Characteristics

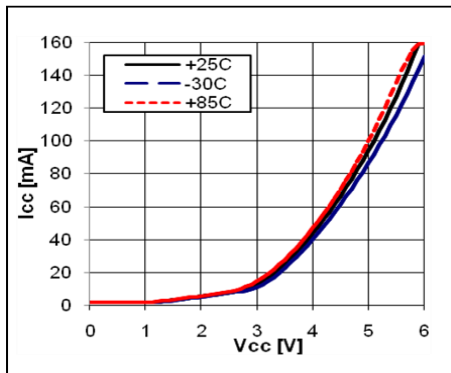

### BeRex SOT89 Evaluation Board

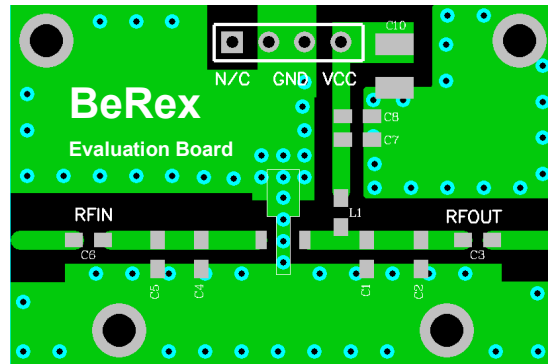

\*Dielectric constant \_ 4.2 \*RF pattern width 52mil \*31mil thick FR4 PCB

### Typical Device Data

S-parameters (V<sub>c</sub>=5V, I<sub>c</sub>=95mA, T=25°C)

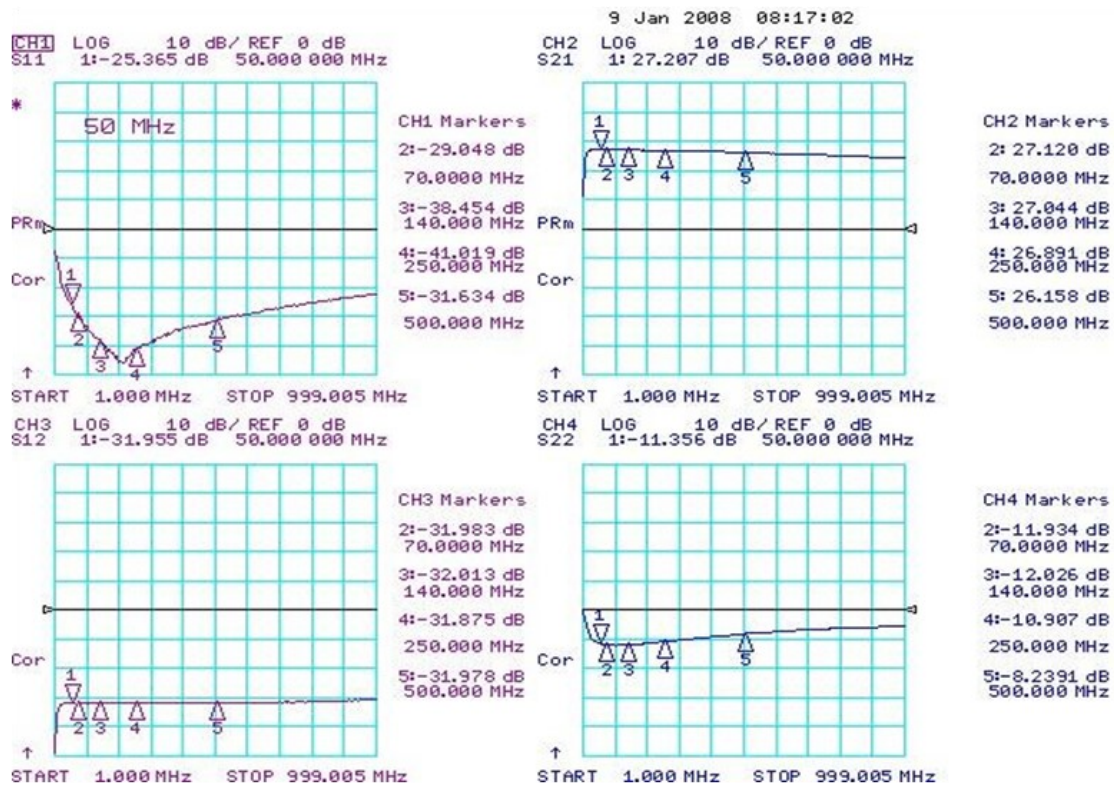

# BIF7

## 5-800 MHz Internally Matched IF Amplifier



### RF Bandwidth

S-parameters (Vc=5V, Ic=95mA, T=25°C)

17 Jan 2008 12:58:33

CH1 LOG 10 dB/ REF 0 dB  
S11 1:-9.2629 dB 500.000 000 MHz

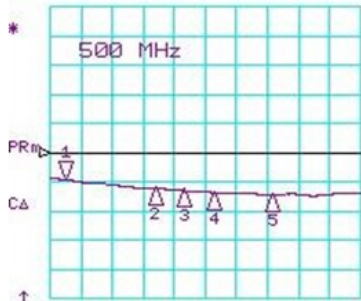

CH1 Markers  
2:-12.116 dB  
800.000 MHz  
3:-12.987 dB  
900.000 MHz  
4:-13.720 dB  
1.00000 GHz  
5:-14.487 dB  
1.20000 GHz

START 450.000 MHz STOP 1500.000 MHz

CH3 LOG 10 dB/ REF 0 dB  
S12 1:-31.481 dB 500.000 000 MHz

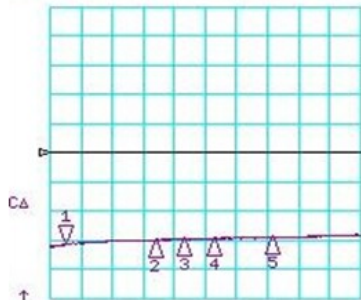

CH3 Markers  
2:-29.807 dB  
800.000 MHz  
3:-29.644 dB  
900.000 MHz  
4:-29.453 dB  
1.00000 GHz  
5:-28.935 dB  
1.20000 GHz

START 450.000 MHz STOP 1500.000 MHz

CH2 LOG 10 dB/ REF 0 dB  
S21 1:26.443 dB 500.000 000 MHz

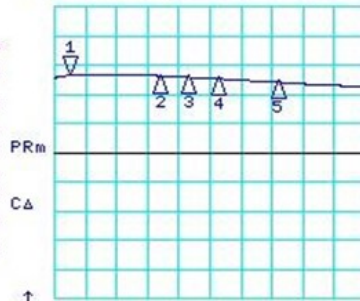

CH2 Markers  
2: 26.334 dB  
800.000 MHz  
3: 25.860 dB  
900.000 MHz  
4: 25.342 dB  
1.00000 GHz  
5: 24.194 dB  
1.20000 GHz

START 450.000 MHz STOP 1500.000 MHz

CH4 LOG 10 dB/ REF 0 dB  
S22 1:-9.4442 dB 500.000 000 MHz

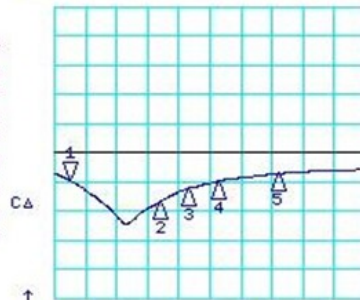

CH4 Markers  
2:-17.183 dB  
800.000 MHz  
3:-12.354 dB  
900.000 MHz  
4:-9.7809 dB  
1.00000 GHz  
5:-7.1466 dB  
1.20000 GHz

START 450.000 MHz STOP 1500.000 MHz

# BIF7



## 5-800 MHz Internally Matched IF Amplifier

### S-Parameter

(V<sub>device</sub> = 5.0V, I<sub>cc</sub> = 95mA, T = 25 °C, calibrated to device leads)

Freq	S11	S11	S21	S21	S12	S12	S22	S22
[MHz]	[Mag]	[Ang]	[Mag]	[Ang]	[Mag]	[Ang]	[Mag]	[Ang]
100	0.590	175.3	25.200	170.9	0.027	2.7	0.242	-20.9
500	0.540	155.4	19.772	139.2	0.027	10.0	0.341	-92.7
1000	0.484	140.8	14.791	116.0	0.028	21.8	0.449	-148.9
1500	0.495	126.4	12.899	102.3	0.039	30.7	0.541	171.2
2000	0.443	114.8	10.915	76.4	0.044	26.5	0.568	139.2
2500	0.492	100.3	9.942	69.3	0.051	33.4	0.593	113.8
3000	0.473	82.1	10.121	41.0	0.062	22.0	0.609	89.9
3500	0.499	70.9	7.532	20.2	0.062	17.5	0.617	69.4
4000	0.558	52.8	6.114	4.8	0.072	6.5	0.617	42.1

Typical Performance (V<sub>d</sub> = 5V, I<sub>c</sub> = 95mA, T = 25°C)

Freq	MHz	70	140	250	500	800
S21	dB	27.1	27.0	26.7	25.7	25
S11	dB	-32.0	-41.1	-38.5	-28.6	-23.2
S22	dB	-12.1	-11.6	-10.1	-7.2	-6.5
P1	dBm	21.3	21.5	21.5	21	19.7
OIP3	dBm	40.0	38.5	38.0	36.0	32.5
NF	dB	2.9	2.9	3.0	3.0	3.0

Typical Performance (V<sub>d</sub> = 4.7V, I<sub>c</sub> = 78mA, T = 25°C)

Freq	MHz	70	140	250	500	800
S21	dB	26.7	26.6	26.4	25.7	24.6
S11	dB	-28.5	-32.5	-29.2	-23.3	-19.8
S22	dB	-10.9	-11	-10.4	-8.2	-6
P1	dBm	20	20.5	20.5	20	19
OIP3	dBm	35.5	35.5	35	33	31.5
NF	dB	2.9	2.9	3.0	3.0	3.0

Typical Performance (V<sub>d</sub> = 4.5V, I<sub>c</sub> = 67mA, T = 25°C)

Freq	MHz	70	140	250	500	800
S21	dB	26.7	26.6	26.2	25.1	24.5
S11	dB	-26.6	-28.2	-26	-21.6	-18.8
S22	dB	-10.5	-10.6	-10.1	-8	-5.8
P1	dBm	18.8	19.2	19.5	19.6	17.4
OIP3	dBm	34.5	34.0	33.0	31.5	33
NF	dB	2.9	2.9	3.0	3.0	3.0

# BIF7

5-800 MHz Internally Matched IF Amplifier



## Device Performance

### Pin-Pout-Gain

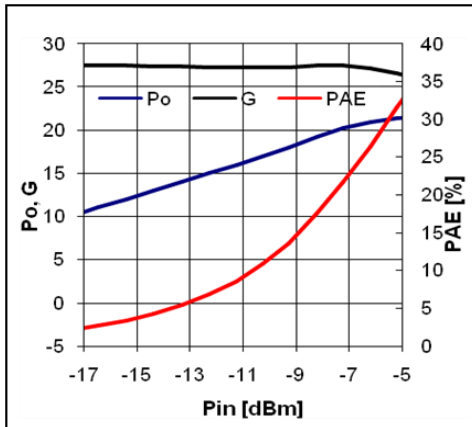

70MHz, 5V/95mA

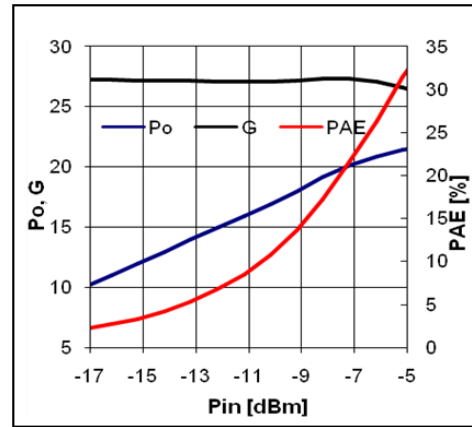

140MHz, 5V/95mA

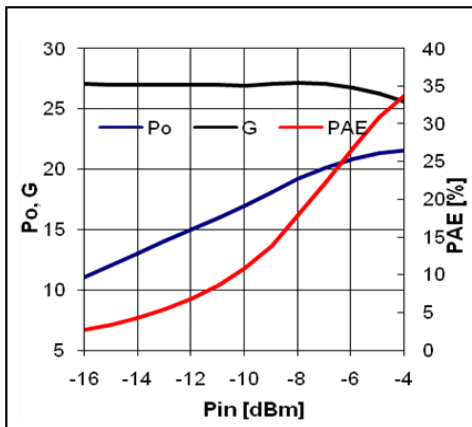

250MHz, 5V/95mA

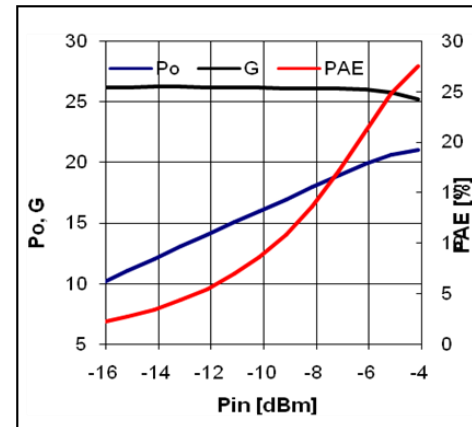

500MHz, 5V/95mA

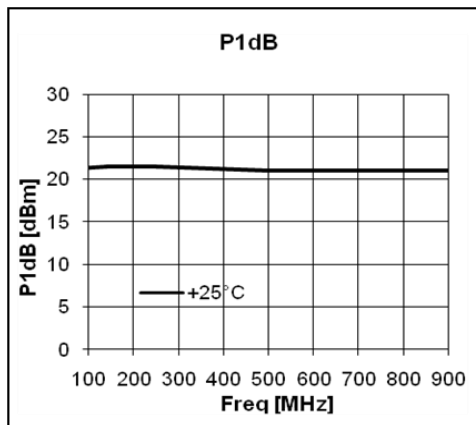

# BIF7

## 5-800 MHz Internally Matched IF Amplifier



### OIP3

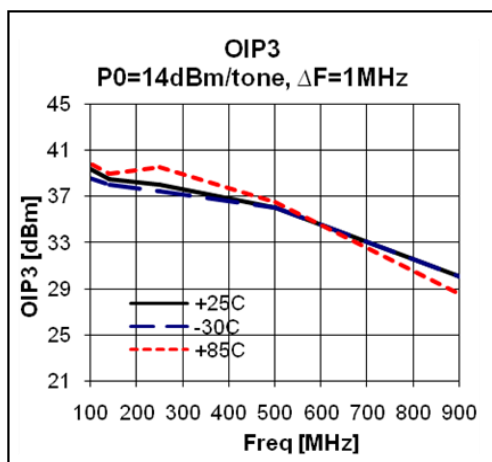
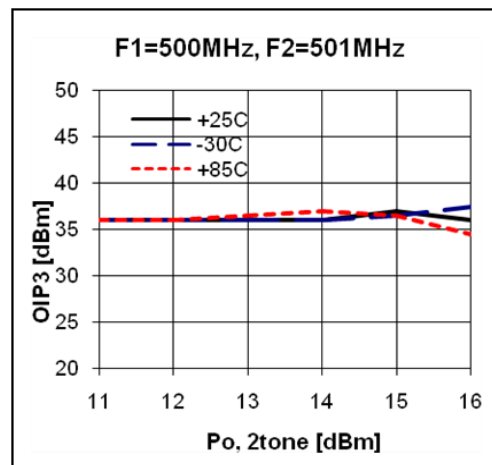
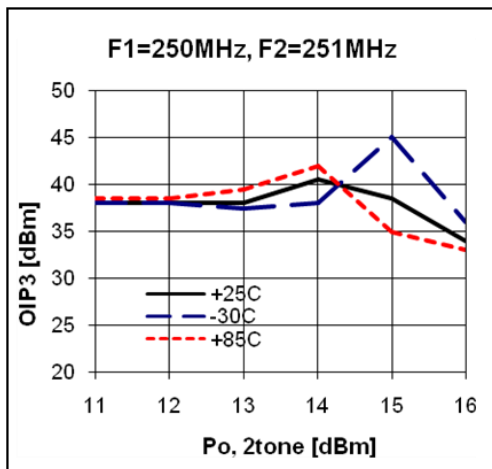
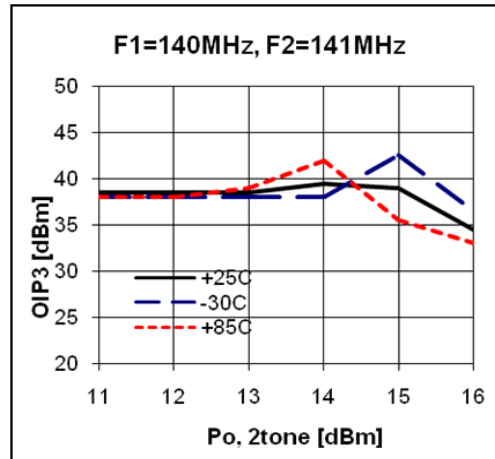
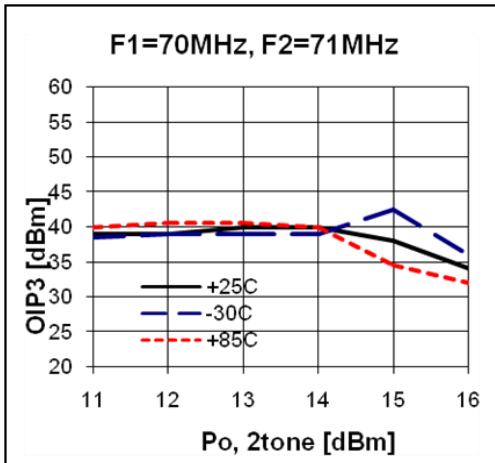

# BIF7

## 5-800 MHz Internally Matched IF Amplifier



### ACPR

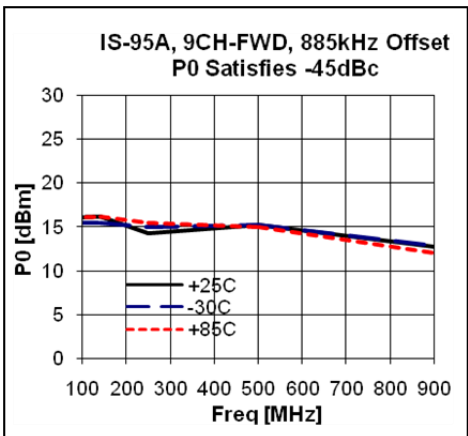
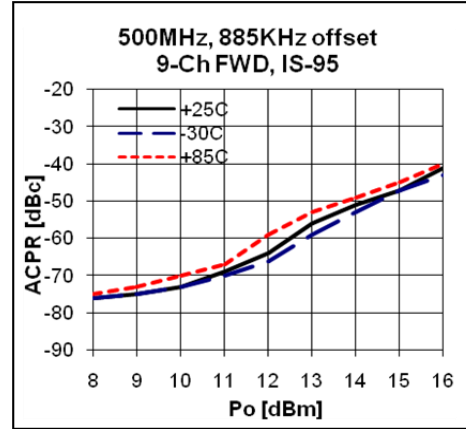
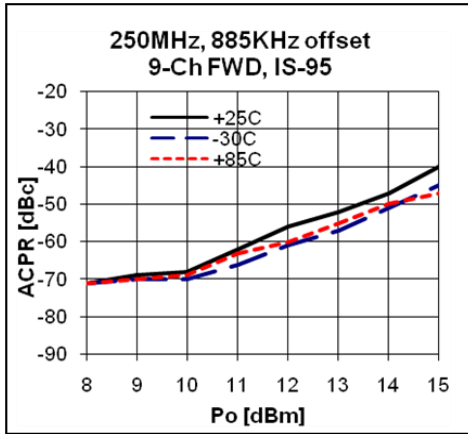
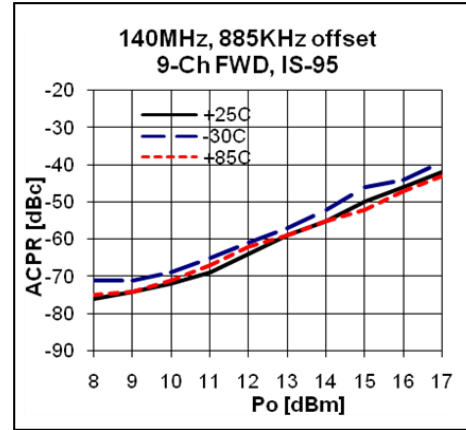
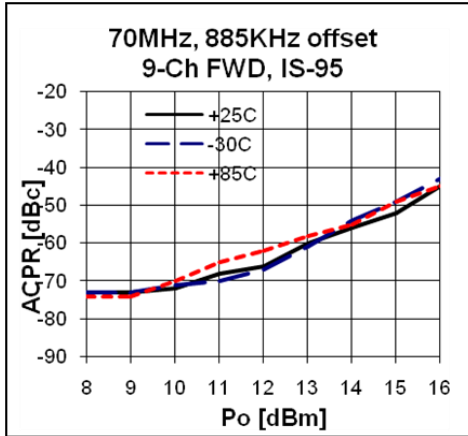



# BIF7

## 5-800 MHz Internally Matched IF Amplifier



### ACLR

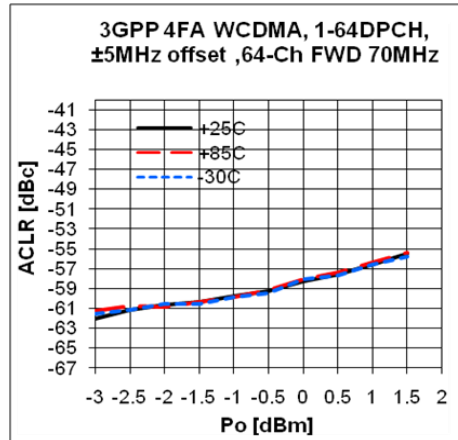

### S-Parameters over Temperature

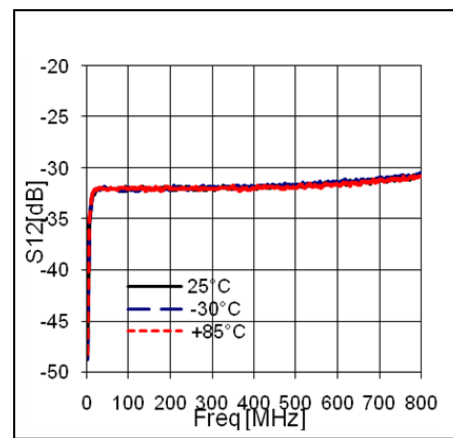
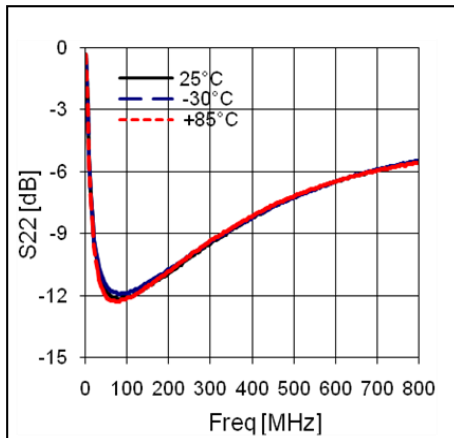
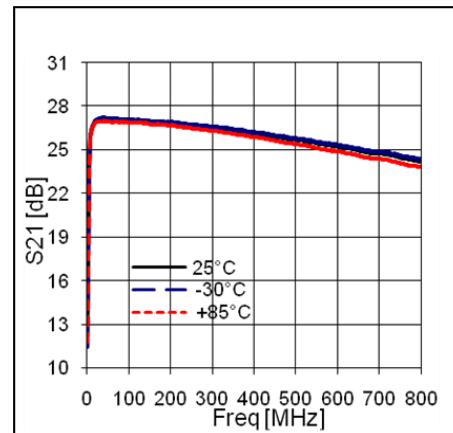
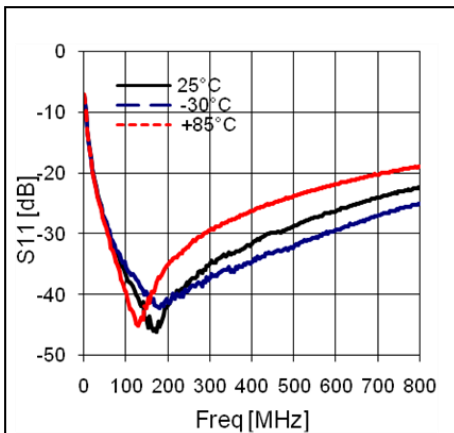



# BIF7

## 5-800 MHz Internally Matched IF Amplifier



### Package Outline Dimension

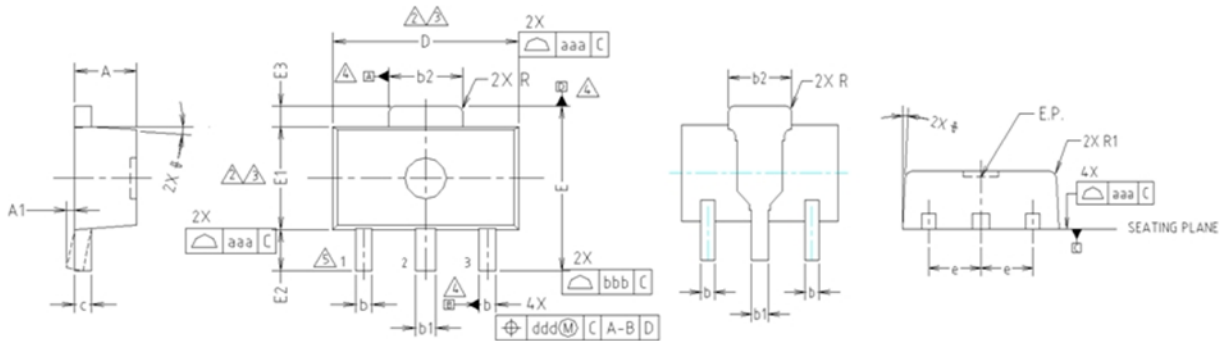

- NOTE:**  
1. DIMENSIONS IN MILLIMETERS.
- ⚠ DIMENSION D DOES NOT INCLUDE MOLD FLASH, PROTRUSIONS OR GATE BURRS. MOLD FLASH, PROTRUSIONS OR GATE BURRS SHALL NOT EXCEED 0.5mm PER END. DIMENSION E1 DOES NOT INCLUDE INTERLEAD FLASH OR PROTRUSION. INTERLEAD FLASH OR PROTRUSION SHALL NOT EXCEED 0.5mm PER SIDE.
  - ⚠ DIMENSIONS D AND E1 ARE DETERMINED AT THE OUTMOST EXTREMES OF THE PLASTIC BODY EXCLUSIVE OF MOLD FLASH, TIE BAR BURRS, GATE BURRS AND INTERLEAD FLASH, BUT INCLUDING ANY MISMATCH BETWEEN THE TOP AND BOTTOM OF THE PLASTIC BODY.
  - ⚠ DATUMS A, B AND D TO BE DETERMINED 0.18mm FROM THE LEAD TIP.
  - ⚠ TERMINAL NUMBERS ARE SHOWN FOR REFERENCE ONLY.

SYMBOL	MILLIMETERS			NOTE
	MINIMUM	NOMINAL	MAXIMUM	
A	1.40	1.50	1.60	
A1	0.00	—	0.10	
b	0.38	0.42	0.48	
b1	0.48	0.52	0.58	
b2	1.79	1.82	1.87	
c	0.40	0.42	0.46	
D	4.40	4.50	4.70	2,3
E	3.70	4.00	4.30	
E1	2.40	2.50	2.70	2,3
E2	0.80	1.00	1.20	
E3	0.40	0.50	0.60	
e	1.50 TYP.			
φ	4° TYP.			
R	0.15 TYP.			
R1	—	—	0.20	
SYMBOL	TOLERANCES OF FORM AND POSITION		NOTE	
aaa	0.15			
bbb	0.20			
ccc	0.10			
ddd	0.10			

### Suggested PCB Land Pattern and PAD Layout

#### PCB Land Pattern

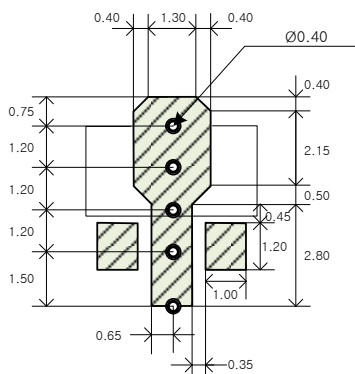

Note : All dimension \_ millimeters

PCB lay out \_ on BeRex website

#### PCB Mounting

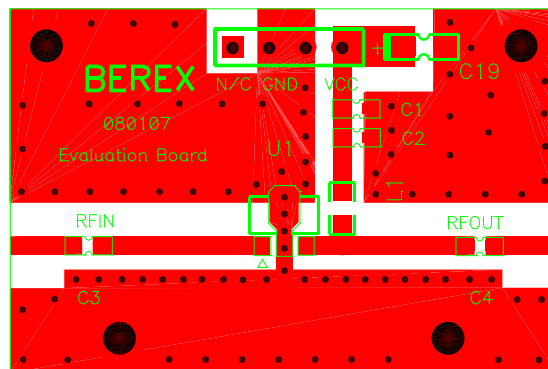

# BIF7

5-800 MHz Internally Matched IF Amplifier



## Package Marking

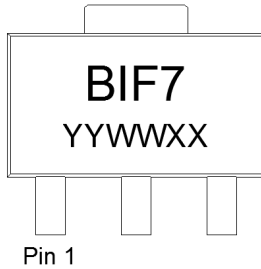

YY = Year, WW = Working Week,  
XX = Wafer No.

## Tape & Reel

SOT89

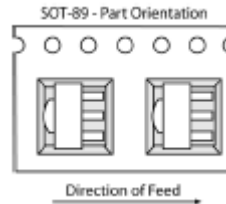

Packaging information:

Tape Width (mm): 12  
Reel Size (inches): 7  
Device Cavity Pitch (mm): 8  
Devices Per Reel: 1000

## Lead plating finish

100% Tin Matte finish

(All BeRex products undergoes a 1 hour, 150 degree C, Anneal bake to eliminate thin whisker growth concerns.)

## MSL / ESD Rating

<b>ESD Rating:</b>	Class 1C
<b>Value:</b>	Passes <2000V
<b>Test:</b>	Human Body Model (HBM)
<b>Standard:</b>	JEDEC Standard JESD22-A114B
<b>MSL Rating:</b>	Level 1 at +265°C convection reflow
<b>Standard:</b>	JEDEC Standard J-STD-020



Proper ESD procedures should be followed when handling this device.

## NATO CAGE code:

2	N	9	6	F
---	---	---	---	---