

# DATA SHEET

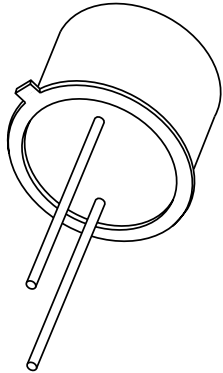

## **BAV45** Picoampere diode

Product specification  
Supersedes data of July 1986

1996 Mar 13

# Picoampere diode

# BAV45

## FEATURES

- Extremely low leakage current: max. 5 pA
- Low diode capacitance
- Light insensitive.

## APPLICATION

- Clamping
- Holding
- Peak follower
- Time delay circuits
- Logarithmic amplifiers
- Protection of insulated gate field-effect transistors.

## DESCRIPTION

Silicon diode in a metal TO-18 can. It has an extremely low leakage current over a wide temperature range combined with a low capacitance and is not sensitive to light.

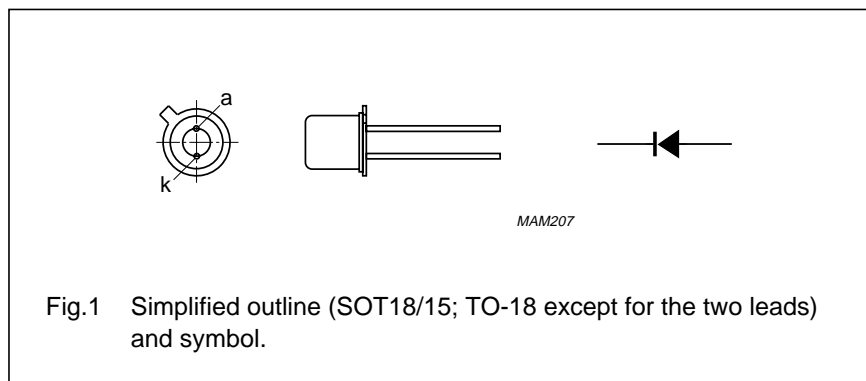

**CAUTION**

Handle the device with care whilst soldering into the circuit. The extremely low leakage current can only be guaranteed when the bottom is free from solder flux or other contaminations.

## LIMITING VALUES

In accordance with the Absolute Maximum Rating System (IEC 134).

SYMBOL	PARAMETER	CONDITIONS	MIN.	MAX.	UNIT
$V_{RRM}$	repetitive peak reverse voltage		–	35	V
$V_R$	continuous reverse voltage		–	20	V
$I_F$	continuous forward current	see Fig.2	–	50	mA
$I_{FRM}$	repetitive peak forward current		–	100	mA
$P_{tot}$	total power dissipation	$T_{amb} = 25\text{ }^\circ\text{C}$ ; note 1	–	200	mW
$T_{stg}$	storage temperature		–65	+125	$^\circ\text{C}$
$T_j$	junction temperature		–	125	$^\circ\text{C}$

### Note

1. Device mounted on a FR4 printed-circuit board.

Picoampere diode

BAV45

**ELECTRICAL CHARACTERISTICS**

$T_j = 25\text{ }^\circ\text{C}$  unless otherwise specified.

SYMBOL	PARAMETER	CONDITIONS	MAX.	UNIT
$V_F$	forward voltage	$I_F = 10\text{ mA}$ ; see Figs 3 and 4	1	V
$I_R$	reverse current	see Fig.5 $V_R = 5\text{ V}$ $V_R = 5\text{ V}; T_j = 80\text{ }^\circ\text{C}$ $V_R = 20\text{ V}$	5 250 10	pA pA pA
$C_d$	diode capacitance	$f = 1\text{ MHz}; V_R = 0$ ; see Fig.6	1.3	pF
$t_{rr}$	reverse recovery time	when switched from $I_F = 10\text{ mA}$ to $I_R = 10\text{ mA}$ ; $R_L = 100\ \Omega$ ; measured at $I_R = 1\text{ mA}$ ; see Fig.7	600	ns

**THERMAL CHARACTERISTICS**

SYMBOL	PARAMETER	VALUE	UNIT
$R_{th\ j-a}$	thermal resistance from junction to ambient; note 1	500	K/W

**Note**

1. Device mounted on a FR4 printed-circuit board.

**GRAPHICAL DATA**

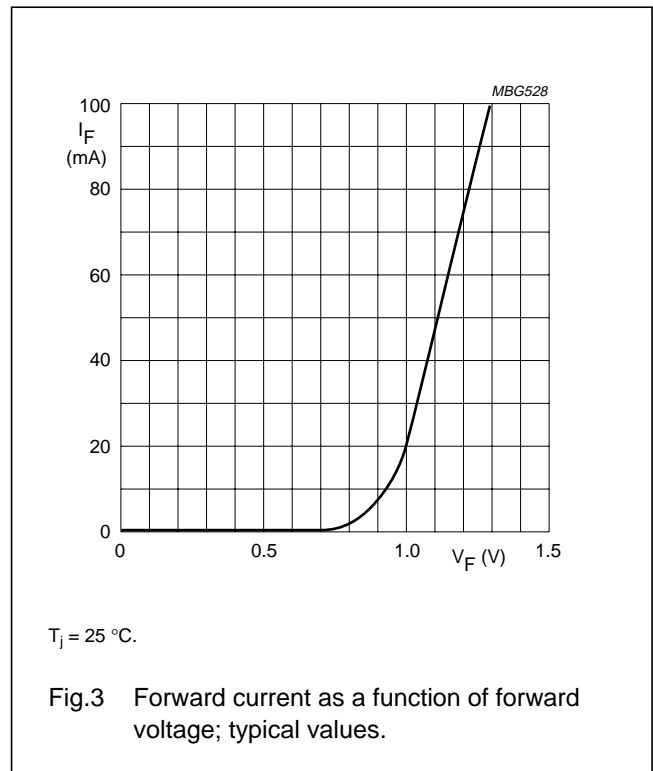
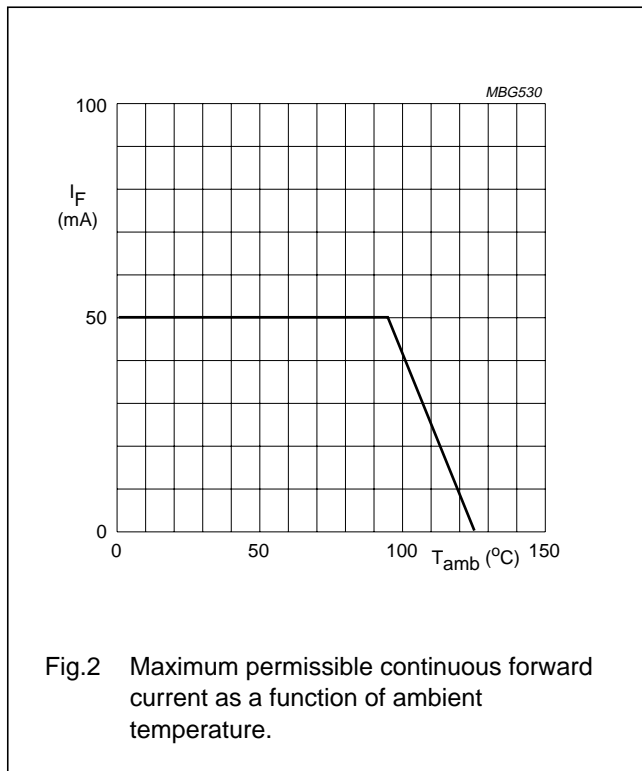

Picoampere diode

BAV45

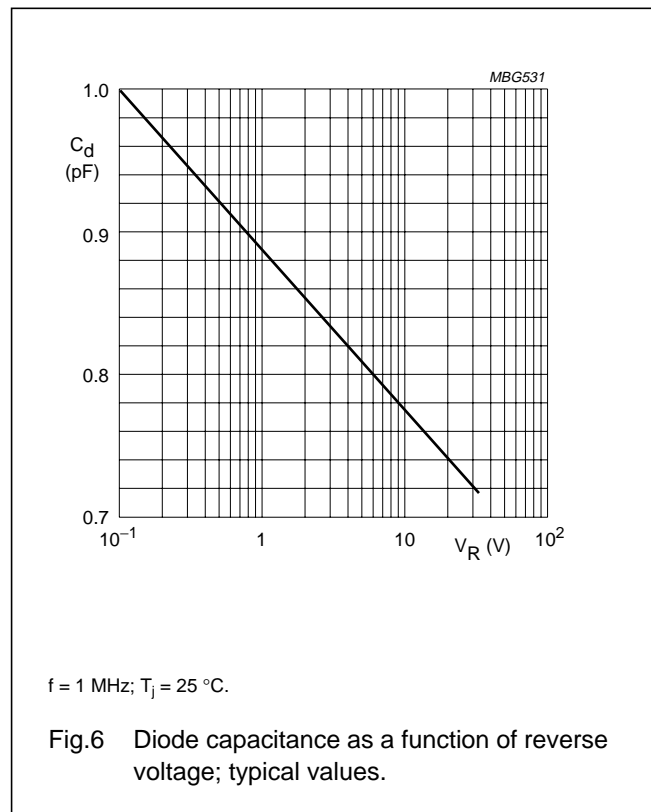
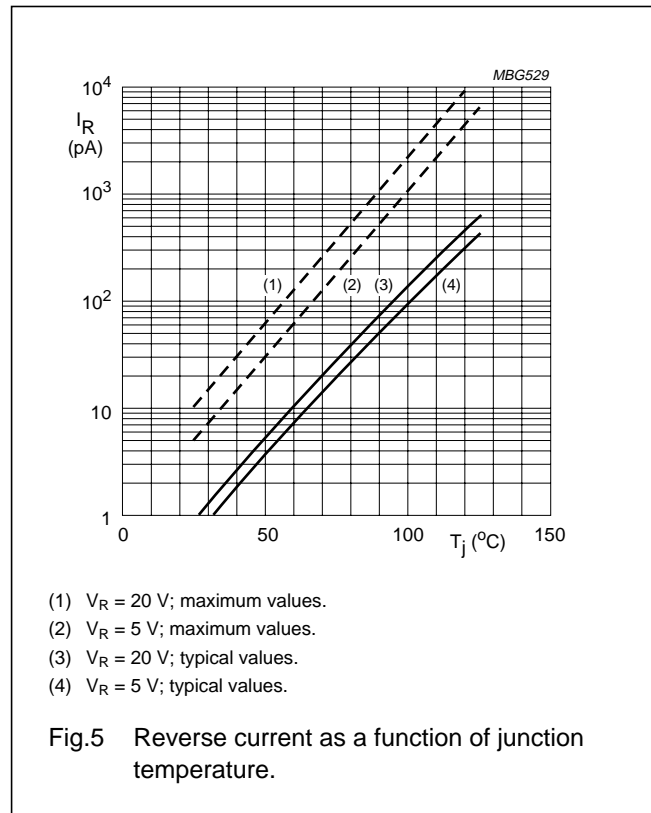
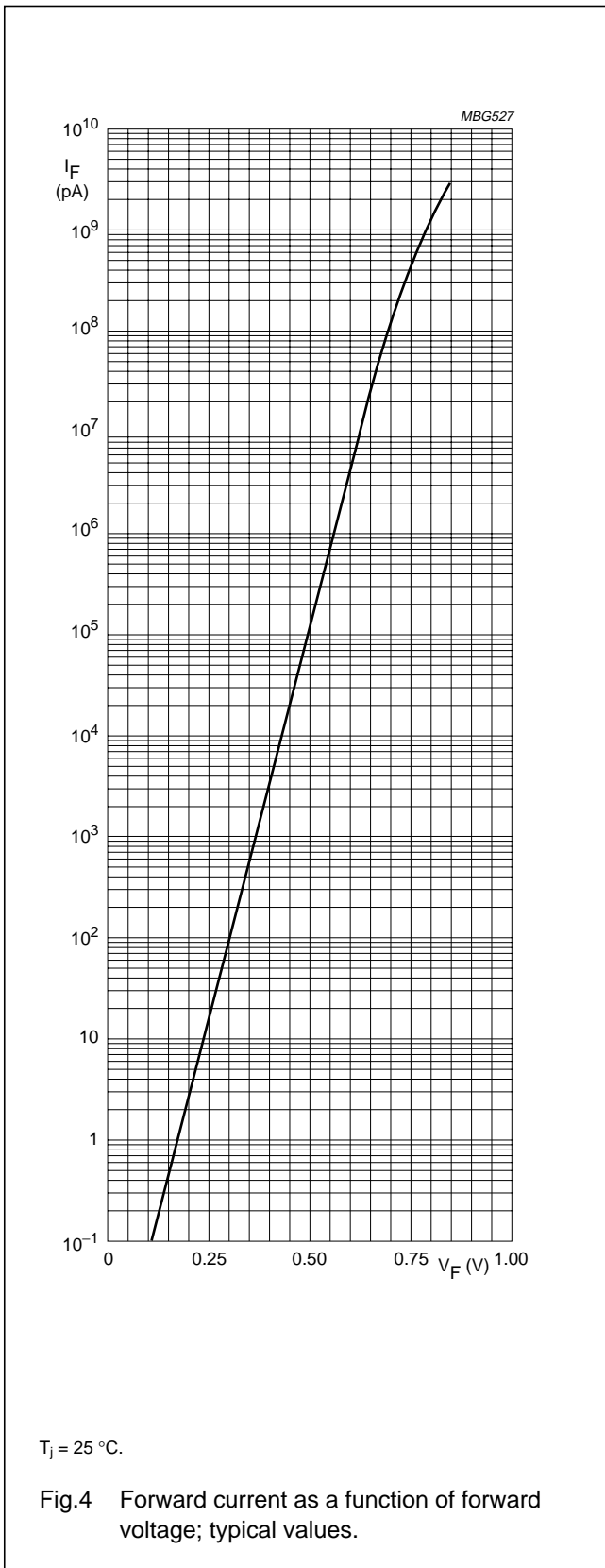

Picoampere diode

BAV45

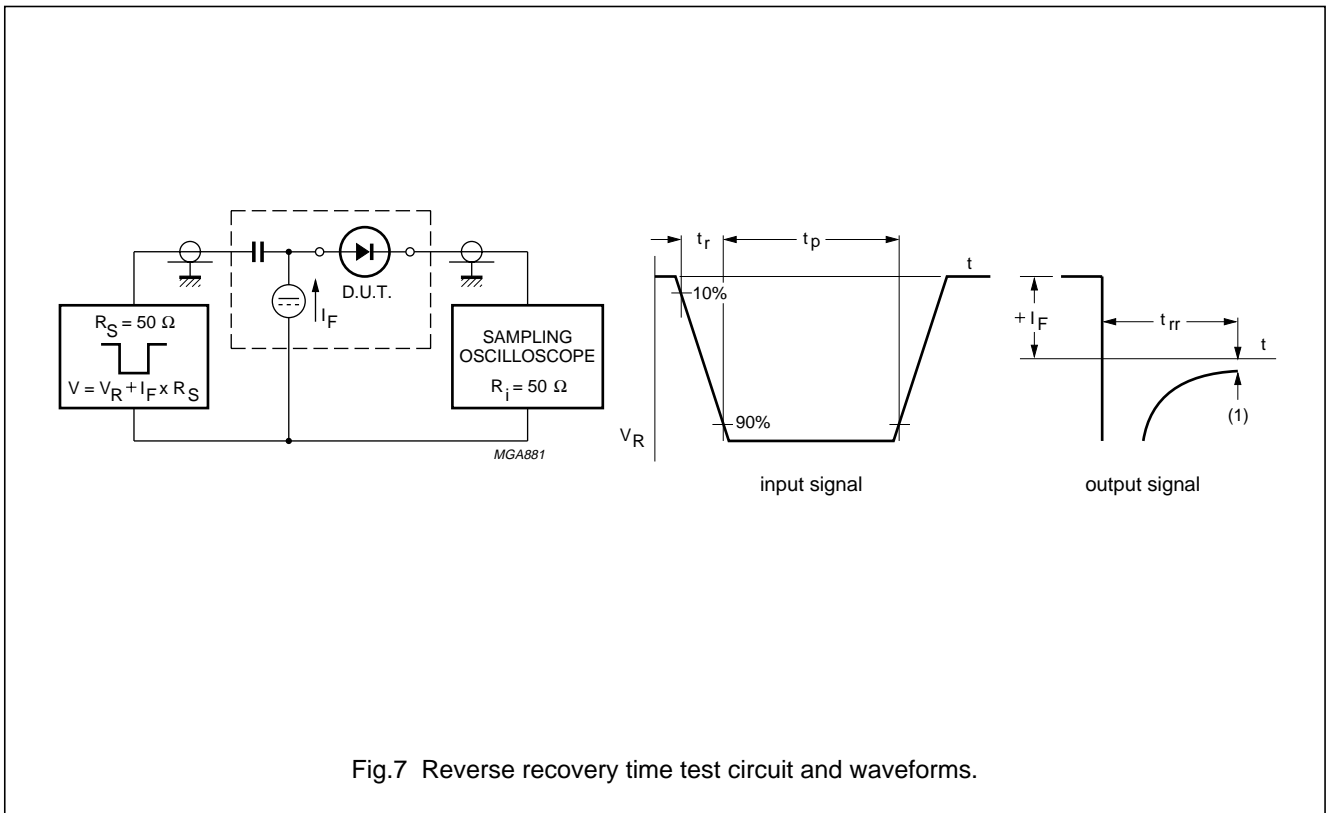
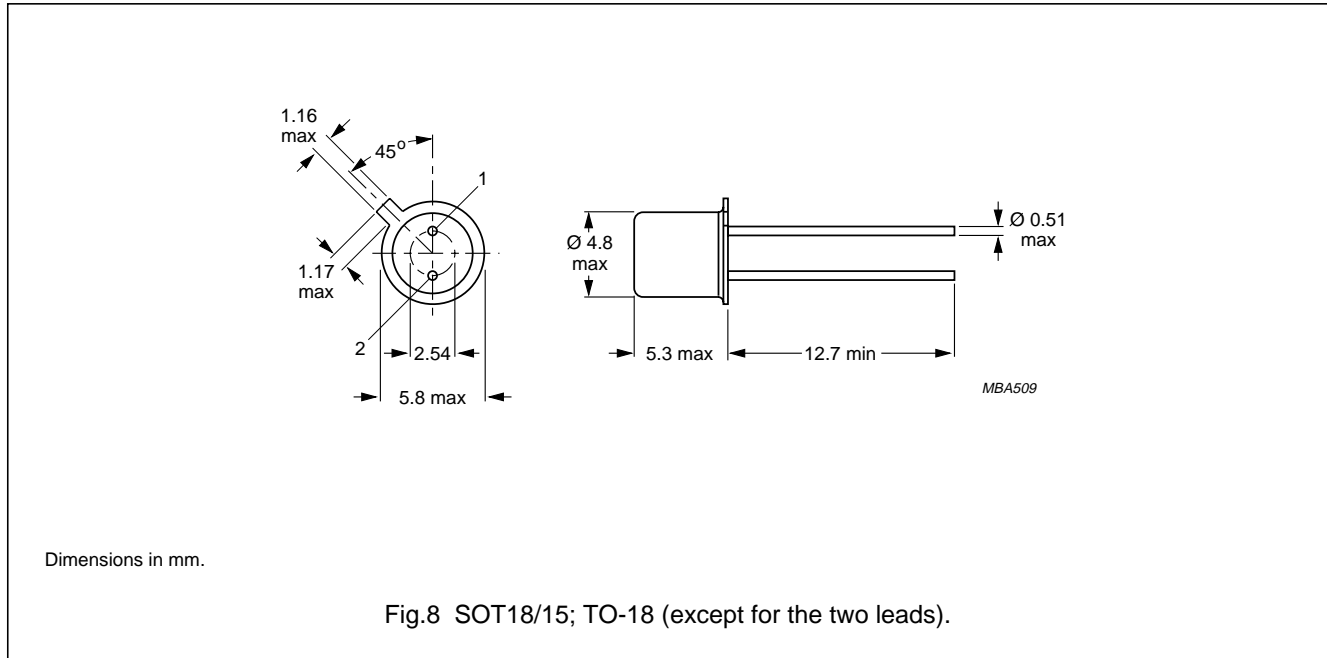

Fig.7 Reverse recovery time test circuit and waveforms.

Picoampere diode

BAV45

PACKAGE OUTLINE



DEFINITIONS

<b>Data Sheet Status</b>	
Objective specification	This data sheet contains target or goal specifications for product development.
Preliminary specification	This data sheet contains preliminary data; supplementary data may be published later.
Product specification	This data sheet contains final product specifications.
<b>Limiting values</b>	
Limiting values given are in accordance with the Absolute Maximum Rating System (IEC 134). Stress above one or more of the limiting values may cause permanent damage to the device. These are stress ratings only and operation of the device at these or at any other conditions above those given in the Characteristics sections of the specification is not implied. Exposure to limiting values for extended periods may affect device reliability.	
<b>Application information</b>	
Where application information is given, it is advisory and does not form part of the specification.	

LIFE SUPPORT APPLICATIONS

These products are not designed for use in life support appliances, devices, or systems where malfunction of these products can reasonably be expected to result in personal injury. Philips customers using or selling these products for use in such applications do so at their own risk and agree to fully indemnify Philips for any damages resulting from such improper use or sale.