

D8740220GTH

GaAs Power Doubler Hybrid
40MHz to 870MHz

The D8740220GTH is a Hybrid Power Doubler amplifier module. The part employs GaAs die and is operated from 40MHz to 870MHz. It provides excellent linearity and superior return loss performance with low noise and optimal reliability.

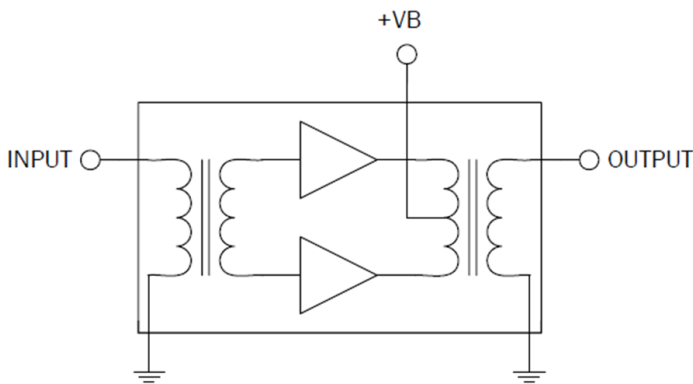

Package: SOT-115J

Features

- Excellent Linearity
- Superior Return Loss Performance
- Extremely Low Distortion
- Optimal Reliability
- Low Noise
- Unconditionally Stable Under All Terminations
- 22.0dB Min. Gain at 870MHz
- 440mA Max. at 24VDC

Applications

- 40MHz to 870MHz CATV Amplifier Systems

Ordering Information

D8740220GTH Box with 50 pieces

Absolute Maximum Ratings

Parameter	Rating	Unit
RF Input Voltage (single tone)	75	dBmV
DC Supply Over-Voltage (5 minutes)	30	V
Storage Temperature	-40 to +100	°C
Operating Mounting Base Temperature	-30 to +100	°C



Caution! ESD sensitive device.



RoHS (Restriction of Hazardous Substances): Compliant per EU Directive 2011/65/EU.

Exceeding any one or a combination of the Absolute Maximum Rating conditions may cause permanent damage to the device. Extended application of Absolute Maximum Rating conditions to the device may reduce device reliability. Specified typical performance or functional operation of the device under Absolute Maximum Rating conditions is not implied.

Nominal Operating Parameters

Parameter	Specification			Unit	Condition
	Min	Typ	Max		
General Performance					V+ = 24V; T_{MB} = 30°C; Z_S = Z_L = 75Ω
Power Gain	21.0	21.5	22.0	dB	f = 50MHz
	22.0	22.5	23.0	dB	f = 870MHz
Slope ⁽¹⁾	0.6	1.0	1.4	dB	f = 40MHz to 870MHz
Flatness of Frequency Response			0.6	dB	f = 40MHz to 870MHz (Peak to Valley)
Input Return Loss	20.0			dB	f = 40MHz to 320MHz
	19.0			dB	f = 320MHz to 640MHz
	17.0			dB	f = 640MHz to 870MHz
Output Return Loss	20.0			dB	f = 40MHz to 320MHz
	19.0			dB	f = 320MHz to 640MHz
	18.0			dB	f = 640MHz to 870MHz
Noise Figure		5.5	6.5	dB	f = 50MHz to 870MHz
Total Current Consumption (DC)		420.0	440.0	mA	
Distortion Data 40MHz to 870MHz					V+ = 24V; T_{MB} = 30°C; Z_S = Z_L = 75Ω
CTB		-66	-64	dBc	79 ch. flat; V ₀ = 48dBmV ^[2]
		-62	-60	dBc	112 ch. flat; V ₀ = 48dBmV ^[3]
		-58	-56	dBc	132 ch. flat; V ₀ = 48dBmV ^[4]
		-63	-61	dBc	79 ch. 7dB tilted; V ₀ = 53dBmV at 550MHz ^[5]
		-57	-55	dBc	112 ch. 10dB tilted; V ₀ = 54dBmV at 750MHz ^[6]
XMOD		-62	-60	dBc	79 ch. flat; V ₀ = 48dBmV ^[2]
		-59	-57	dBc	112 ch. flat; V ₀ = 48dBmV ^[3]
		-57	-55	dBc	132 ch. flat; V ₀ = 48dBmV ^[4]
		-60	-58	dBc	79 ch. 7dB tilted; V ₀ = 53dBmV at 550MHz ^[5]
		-53	-51	dBc	112 ch. 10dB tilted; V ₀ = 54dBmV at 750MHz ^[6]
CSO		-70	-68	dBc	79 ch. flat; V ₀ = 48dBmV ^[2]
		-66	-64	dBc	112 ch. flat; V ₀ = 48dBmV ^[3]
		-64	-62	dBc	132 ch. flat; V ₀ = 48dBmV ^[4]
		-69	-67	dBc	79 ch. 7dB tilted; V ₀ = 53dBmV at 550MHz ^[5]
		-65	-63	dBc	112 ch. 10dB tilted; V ₀ = 54dBmV at 750MHz ^[6]

1. The slope is defined as the difference between the gain at the start frequency and the gain at the stop frequency.

2. 79 channels, NTSC frequency raster: 55.25MHz to 547.25MHz, +48dBmV flat output level.

3. 112 channels, NTSC frequency raster: 55.25MHz to 745.25MHz, +48dBmV flat output level.

4. 132 channels, NTSC frequency raster: 55.25MHz to 865.25MHz, +48dBmV flat output level.

5. 79 channels, NTSC frequency raster: 55.25MHz to 547.25MHz, +46dBmV to +53dBmV tilted output level.

6. 112 channels, NTSC frequency raster: 55.25MHz to 745.25MHz, +44dBmV to +54dBmV tilted output level.

Composite Second Order (CSO) - The CSO parameter (both sum and difference products) is defined by the NCTA. Composite Triple Beat (CTB) - The CTB parameter is defined by the NCTA. Cross Modulation (XMOD) - Cross modulation (XMOD) is measured at baseband (selective voltmeter method), referenced to 100% modulation of the carrier being tested.

Package Drawing (Dimensions in millimeters)

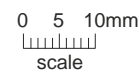
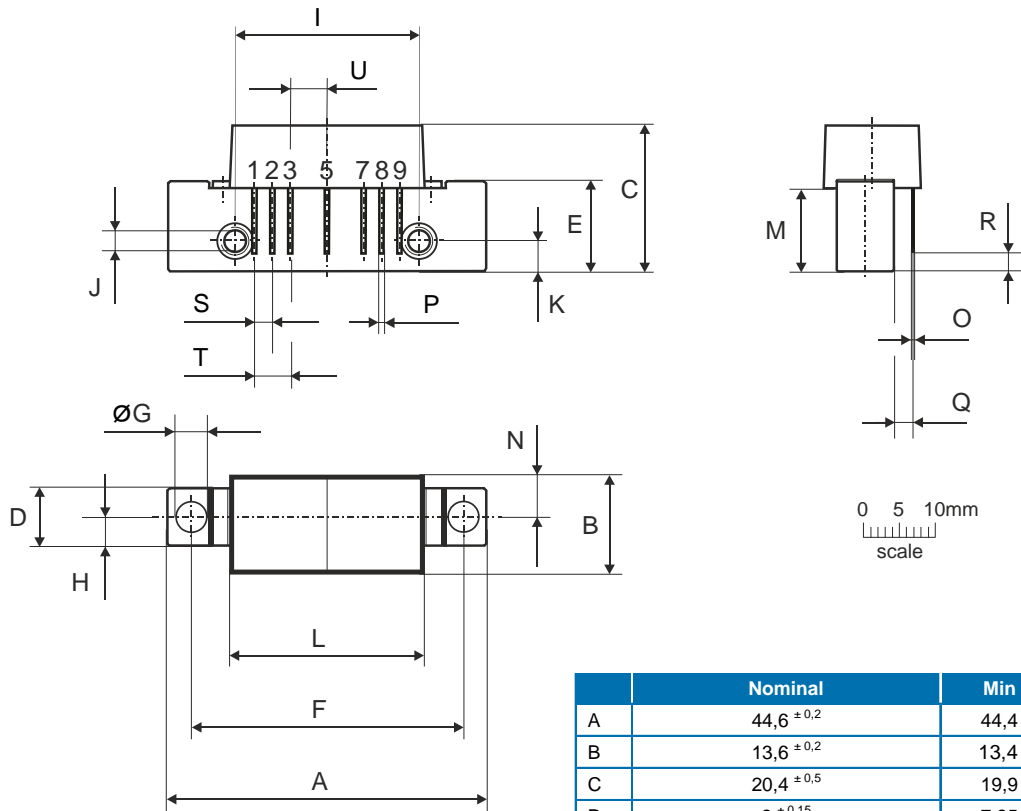

Notes:

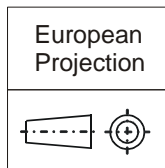

Pinning:

Pin	Name
1	Input
2-3	GND
4	
5	+VB
6	
7-8	GND
9	Output

	Nominal	Min	Max
A	44,6 ±0,2	44,4	44,8
B	13,6 ±0,2	13,4	13,8
C	20,4 ±0,5	19,9	20,9
D	8 ±0,15	7,85	8,15
E	12,6 ±0,15	12,45	12,75
F	38,1 ±0,2	37,9	38,3
G	4 ^{+0,2/-0,05}	3,95	4,2
H	4 ±0,2	3,8	4,2
I	25,4 ±0,2	25,2	25,6
J	UNC 6-32	-	-
K	4,2 ±0,2	4,0	4,4
L	27,2 ±0,2	27,0	27,4
M	11,6 ±0,5	11,1	12,1
N	5,8 ±0,4	5,4	6,2
O	0,25 ±0,02	0,23	0,27
P	0,45 ±0,03	0,42	0,48
Q	2,54 ±0,3	2,24	2,84
R	2,54 ±0,5	2,04	3,04
S	2,54 ±0,25	2,29	2,79
T	5,08 ±0,25	4,83	5,33
U	5,08 ±0,25	4,83	5,33