

TMPIM 50 A CIB/CI Module

NXH50C120L2C2ESG, NXH50C120L2C2ES1G

The NXH50C120L2C2ESG is a transfer-molded power module with low thermal resistance substrate containing a converter-inverter-brake circuit consisting of six 50 A, 1600 V rectifiers, six 50 A, 1200 V IGBTs with inverse diodes, one 35 A, 1200 V brake IGBT with brake diode and an NTC thermistor.

The NXH50C120L2C2ES1G is a transfer-molded power module with low thermal resistance substrate containing a converter-inverter circuit consisting of six 50 A, 1600 V rectifiers, six 50 A, 1200 V IGBTs with inverse diodes, and an NTC thermistor.

Features

- Low Thermal Resistance Substrate for Low Thermal Resistance
- Lower Package Height than Standard Case Modules
- 6 mm Clearance distance between pin to heatsink
- Compact 73 mm × 40 mm × 8 mm Package
- Solderable Pins
- Thermistor
- These Devices are Pb-Free, Halogen Free/BFR Free and are RoHS Compliant

Typical Applications

- Industrial Motor Drives
- Servo Drives

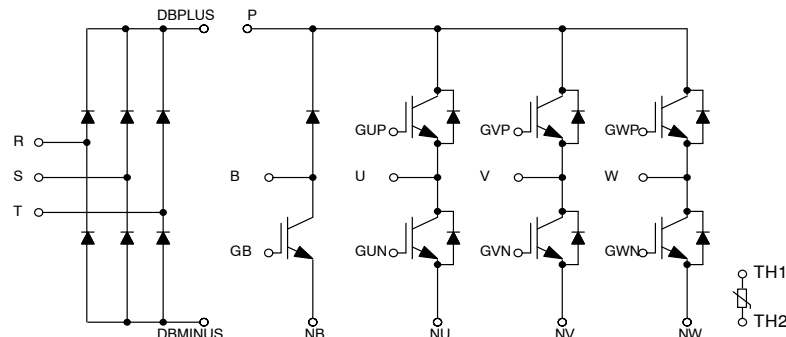

Figure 1. NXH50C120L2C2ESG Schematic Diagram

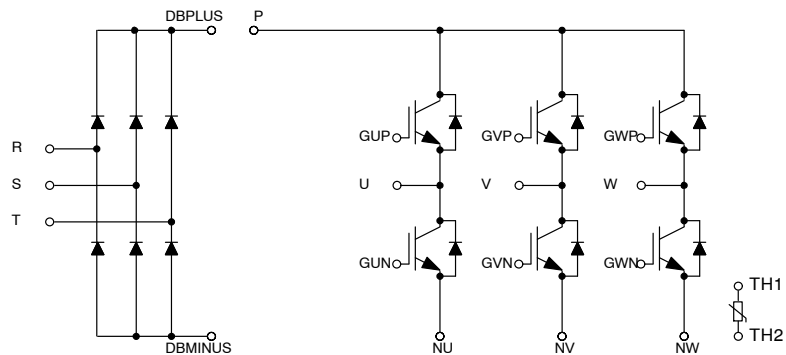
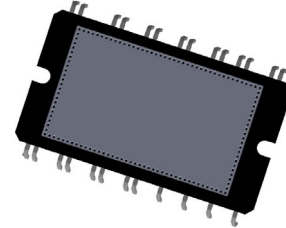

Figure 2. NXH50C120L2C2ES1G Schematic Diagram



ON Semiconductor®

www.onsemi.com



DIP26 67.8x40
CASE 181AD

MARKING DIAGRAM

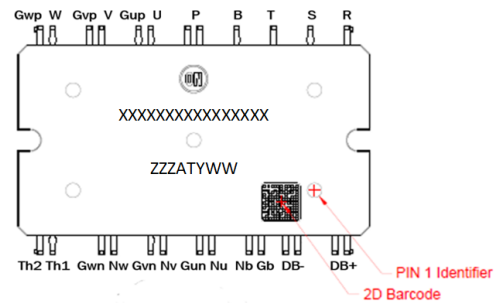

XXXXX = Specific Device Code
ZZZ = Assembly Lot Code
AT = Assembly & Test Site Code
YYWW = Year and Work Week Code

ORDERING INFORMATION

Device	Package	Shipping†
NXH50C120L2C2ESG	DIP26	6 Units / Tube
NXH50C120L2C2ES1G	(Pb-Free)	

NXH50C120L2C2ESG, NXH50C120L2C2ES1G

MAXIMUM RATINGS (Note 1)

Rating	Symbol	Value	Unit
IGBT (INVERTER, BRAKE)			
Collector-emitter Voltage	V_{CES}	1200	V
Gate-emitter Voltage	V_{GE}	± 20	V
Inverter IGBT Continuous Collector Current @ $T_C = 100^\circ\text{C}$ ($T_{VJmax} = 175^\circ\text{C}$)	I_C	50	A
Inverter IGBT Pulsed Collector Current ($T_{VJmax} = 175^\circ\text{C}$)	I_{Cpulse}	150	A
Brake IGBT Continuous Collector Current @ $T_C = 100^\circ\text{C}$ ($T_{VJmax} = 175^\circ\text{C}$)	I_C	35	A
Brake IGBT Pulsed Collector Current ($T_{VJmax} = 175^\circ\text{C}$)	I_{Cpulse}	105	A

DIODE (INVERTER, BRAKE)

Peak Repetitive Reverse Voltage	V_{RRM}	1200	V
Inverter Diode Continuous Forward Current @ $T_C = 80^\circ\text{C}$ ($T_{VJmax} = 17^\circ\text{C}$)	I_F	50	A
Inverter Diode Repetitive Peak Forward Current ($T_{VJmax} = 175^\circ\text{C}$)	I_{FRM}	150	A
Inverter Diode I^2t value (60 Hz single half-sine wave)	I^2t	94	A^2t
Brake Diode Continuous Forward Current @ $T_C = 80^\circ\text{C}$ ($T_{VJmax} = 175^\circ\text{C}$)	I_F	35	A
Brake Diode Repetitive Peak Forward Current ($T_{VJmax} = 175^\circ\text{C}$)	I_{FRM}	105	A
Brake Diode I^2t value (60 Hz single half-sine wave)	I^2t	46	A^2t

RECTIFIER DIODE

Peak Repetitive Reverse Voltage	V_{RRM}	1600	V
Continuous Forward Current @ $T_C = 80^\circ\text{C}$ ($T_{VJmax} = 150^\circ\text{C}$)	I_F	50	A
Repetitive Peak Forward Current ($T_{VJmax} = 150^\circ\text{C}$)	I_{FRM}	150	A
I^2t value (60 Hz single half-sine wave) @ 25°C (60 Hz single half-sine wave) @ 150°C	I^2t	1126 510	A^2t
Surge current (10ms sin180°) @ 25°C	IFSM	520	A

MODULE THERMAL PROPERTIES

Storage Temperature Range	T_{stg}	-40 to 125	$^\circ\text{C}$
---------------------------	-----------	------------	------------------

INSULATION PROPERTIES

Isolation Test Voltage, $t = 1$ s, 50 Hz	V_{is}	3000	V_{RMS}
Internal Isolation		HPS	
Creepage Distance		6.0	mm
Clearance Distance		6.0	mm
Comperative Tracking Index	CTI	>400	

Stresses exceeding those listed in the Maximum Ratings table may damage the device. If any of these limits are exceeded, device functionality should not be assumed, damage may occur and reliability may be affected.

1. Refer to ELECTRICAL CHARACTERISTICS, RECOMMENDED OPERATING RANGES and/or APPLICATION INFORMATION for Safe Operating parameters.

NXH50C120L2C2ESG, NXH50C120L2C2ES1G

ELECTRICAL CHARACTERISTICS (T_J = 25°C unless otherwise specified)

Parameter	Test Conditions	Symbol	Min	Typ	Max	Unit	
INVERTER IGBT CHARACTERISTICS							
Collector-emitter Cutoff Current	V _{GE} = 0 V, V _{CE} = 1200 V	I _{CES}	–	–	250	μA	
Collector-emitter Saturation Voltage	V _{GE} = 15 V, I _C = 50 A, T _J = 25°C	V _{CE(sat)}	–	1.8	2.4	V	
	V _{GE} = 15 V, I _C = 50 A, T _J = 150°C		–	2	–		
Gate-emitter Threshold Voltage	V _{GE} = V _{CE} , I _C = 6 mA	V _{GE(TH)}	4.8	6	6.8	V	
Gate Leakage Current	V _{GE} = 20 V, V _{CE} = 0 V	I _{GES}	–	–	400	nA	
Turn-on Delay Time	T _J = 25°C V _{CE} = 600 V, I _C = 50 A V _{GE} = ±15 V, R _G = 15 Ω	t _{d(on)}	–	144	–	ns	
Rise Time		t _r	–	104	–		
Turn-off Delay Time		t _{d(off)}	–	380	–		
Fall Time		t _f	–	52	–		
Turn-on Switching Loss per Pulse		E _{on}	–	5870	–		μJ
Turn-off Switching Loss per Pulse		E _{off}	–	1700	–		
Turn-on Delay Time		T _J = 150°C V _{CE} = 600 V, I _C = 50 A V _{GE} = ±15 V, R _G = 15 Ω	t _{d(on)}	–	136		–
Rise Time	t _r		–	112	–		
Turn-off Delay Time	t _{d(off)}		–	432	–		
Fall Time	t _f		–	184	–		
Turn-on Switching Loss per Pulse	E _{on}		–	9530	–	μJ	
Turn-off Switching Loss per Pulse	E _{off}		–	3800	–		
Input Capacitance	V _{CE} = 20 V, V _{GE} = 0 V, f = 100 kHz		C _{ies}	–	11897	–	pF
Output Capacitance		C _{oes}	–	416	–		
Reverse Transfer Capacitance		C _{res}	–	240	–		
Total Gate Charge	V _{CE} = 600 V, I _C = 50 A, V _{GE} = 0 V ~ ±15 V	Q _g	–	558	–	nC	
Temperature under switching conditions		T _{vj op}	–40		150	°C	
Thermal Resistance – Chip-to-Case		R _{thJC}	–	0.26	–	°C/W	

INVERSE DIODE CHARACTERISTICS

Diode Forward Voltage	I _F = 50 A, T _J = 25°C	V _F	–	1.9	2.7	V
	I _F = 50 A, T _J = 150°C		–	1.7	–	
Reverse Recovery Charge	T _J = 25°C V _{CE} = 600 V, I _C = 50 A V _{GE} = ±15 V, R _G = 15 Ω	Q _{rr}	–	2.58	–	μC
Peak Reverse Recovery Current		I _{RRM}	–	20	–	A
Reverse Recovery Energy		E _{rr}	–	640	–	μJ
Reverse Recovery Charge	T _J = 150°C V _{CE} = 600 V, I _C = 50 A V _{GE} = ±15 V, R _G = 15 Ω	Q _{rr}	–	8.0	–	μC
Peak Reverse Recovery Current		I _{RRM}	–	32.5	–	A
Reverse Recovery Energy		E _{rr}	–	2300	–	μJ
Temperature under switching conditions		T _{vj op}	–40		150	°C
Thermal Resistance – Chip-to-Case		R _{thJC}	–	0.42	–	°C/W

NXH50C120L2C2ESG, NXH50C120L2C2ES1G

ELECTRICAL CHARACTERISTICS (T_J = 25°C unless otherwise specified) (continued)

Parameter	Test Conditions	Symbol	Min	Typ	Max	Unit
-----------	-----------------	--------	-----	-----	-----	------

RECTIFIER DIODE CHARACTERISTICS

Diode Forward Voltage	I _F = 50 A, T _J = 25°C	V _F	–	1.2	1.6	V
	I _F = 50 A, T _J = 150°C		–	1.1	–	
Temperature under switching conditions		T _{vj op}	–40		150	°C
Thermal Resistance – Chip-to-Case		R _{thJC}	–	0.33	–	°C/W

BRAKE IGBT CHARACTERISTICS

Collector-emitter Cutoff Current	V _{GE} = 0 V, V _{CE} = 1200 V	I _{CES}	–	–	250	μA	
Collector-emitter Saturation Voltage	V _{GE} = 15 V, I _C = 35 A, T _J = 25°C	V _{CE(sat)}	–	1.8	2.4	V	
	V _{GE} = 15 V, I _C = 35 A, T _J = 125°C		–	1.9	–		
Gate-emitter Threshold Voltage	V _{GE} = V _{CE} , I _C = 4.25 mA	V _{GE(TH)}	4.8	6	6.8	V	
Gate Leakage Current	V _{GE} = 20 V, V _{CE} = 0 V	I _{GES}	–	–	400	nA	
Turn-on Delay Time	T _J = 25°C V _{CE} = 600 V, I _C = 35 A V _{GE} = ±15 V, R _G = 15 Ω	t _{d(on)}	–	104	–	ns	
Rise Time		t _r	–	64	–		
Turn-off Delay Time		t _{d(off)}	–	277	–		
Fall Time		t _f	–	53	–		
Turn-on Switching Loss per Pulse		T _J = 150°C V _{CE} = 600 V, I _C = 35 A V _{GE} = ±15 V, R _G = 15 Ω	E _{on}	–	2900	–	μJ
Turn off Switching Loss per Pulse			E _{off}	–	1200	–	
Turn-on Delay Time			t _{d(on)}	–	168	–	ns
Rise Time			t _r	–	72	–	
Turn-off Delay Time	t _{d(off)}		–	320	–		
Fall Time	t _f		–	165	–		
Turn-on Switching Loss per Pulse	V _{CE} = 20 V, V _{GE} = 0 V, f = 100 kHz		E _{on}	–	4030	–	μJ
Turn off Switching Loss per Pulse			E _{off}	–	2200	–	
Input Capacitance		C _{ies}	–	8333	–	pF	
Output Capacitance			C _{oes}	–	298		–
Reverse Transfer Capacitance			C _{res}	–	175		–
Total Gate Charge		V _{CE} = 600 V, I _C = 35 A, V _{GE} = 0V ~ +15 V	Q _g	–	360	–	nC
Temperature under switching conditions			T _{vj op}	–40		150	°C
Thermal Resistance – Chip-to-Case			R _{thJC}	–	0.42	–	°C/W

BRAKE DIODE CHARACTERISTICS

Brake Diode Reverse Leakage Current	VR = 1200 V	IR	–	–	200	μA	
Diode Forward Voltage	I _F = 35 A, T _J = 25°C	V _F	–	2.2	2.7	V	
	I _F = 35 A, T _J = 150°C		–	2	–		
Reverse Recovery Time	T _J = 25°C V _{CE} = 600 V, I _C = 35 A V _{GE} = ±15 V, R _G = 15 Ω	t _{rr}	–	224	–	ns	
Reverse Recovery Charge		Q _{rr}	–	1.51	–	°C	
Peak Reverse Recovery Current		I _{RRM}	–	18	–	A	
Reverse Recovery Energy		E _{rr}	–	410	–	μJ	
Reverse Recovery Time		T _J = 150°C V _{CE} = 600 V, I _C = 35 A V _{GE} = ±15 V, R _G = 15 Ω	t _{rr}	–	532	–	ns
Reverse Recovery Charge			Q _{rr}	–	5,36	–	°C
Peak Reverse Recovery Current			I _{RRM}	–	30	–	A
Reverse Recovery Energy			E _{rr}	–	1983	–	μJ
Temperature under switching conditions			T _{vj op}	–40		150	°C
Thermal Resistance – Chip-to-Case			R _{thJC}	–	0.65	–	°C/W

NXH50C120L2C2ESG, NXH50C120L2C2ES1G

ELECTRICAL CHARACTERISTICS (T_J = 25°C unless otherwise specified) (continued)

Parameter	Test Conditions	Symbol	Min	Typ	Max	Unit
THERMISTOR CHARACTERISTICS						
Nominal Resistance	T = 25°C	R ₂₅	–	5	–	kΩ
Nominal Resistance	T = 100°C	R ₁₀₀	–	493.3	–	Ω
Deviation of R25		ΔR/R	–5	–	5	%
Power Dissipation		P _D	–	20	–	mW
Power Dissipation Constant			–	1.4	–	mW/K
B-value	B(25/50), tolerance ±2%		–	3375	–	K
B-value	B(25/100), tolerance ±2%		–	3433	–	K

Product parametric performance is indicated in the Electrical Characteristics for the listed test conditions, unless otherwise noted. Product performance may not be indicated by the Electrical Characteristics if operated under different conditions.

NXH50C120L2C2ESG, NXH50C120L2C2ES1G

TYPICAL CHARACTERISTICS – INVERTER IGBT & INVERSE DIODE

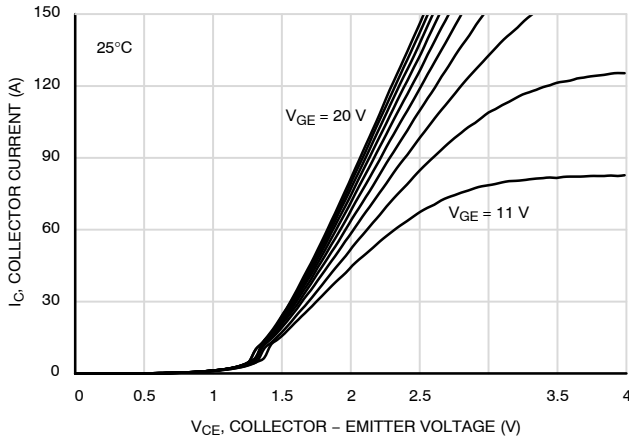

Figure 3. Inverter IGBT Typical Output Characteristic (25°C)

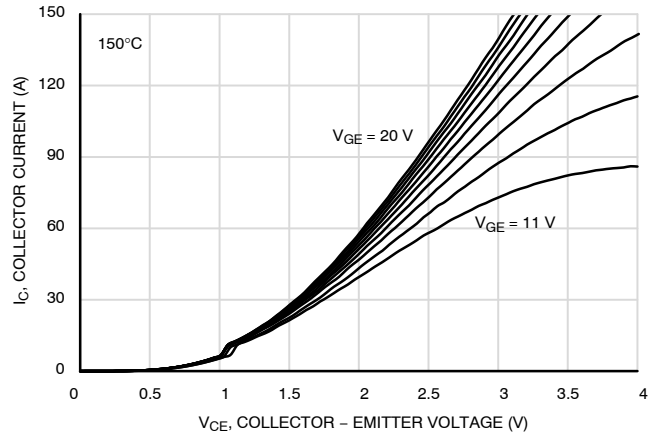

Figure 4. Inverter IGBT Typical Output Characteristic (150°C)

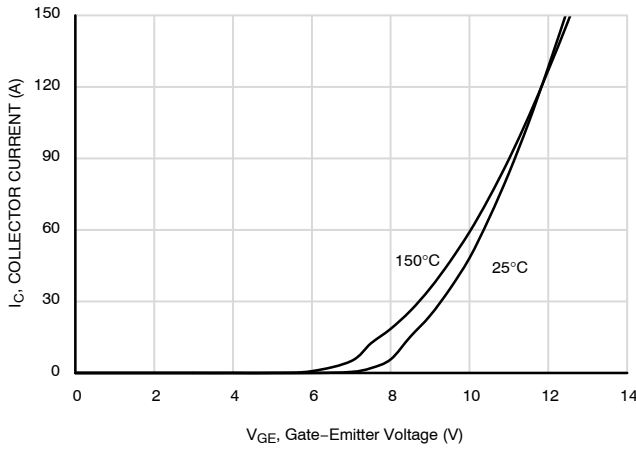

Figure 5. Inverter IGBT Typical Transfer Characteristic

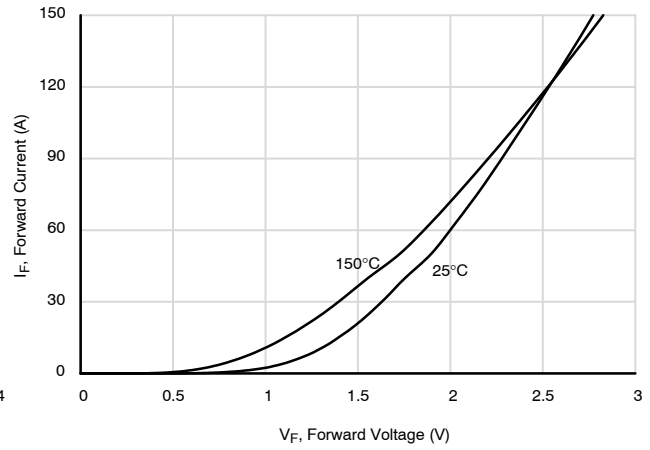

Figure 6. Inverter Diode Typical Forward Characteristic

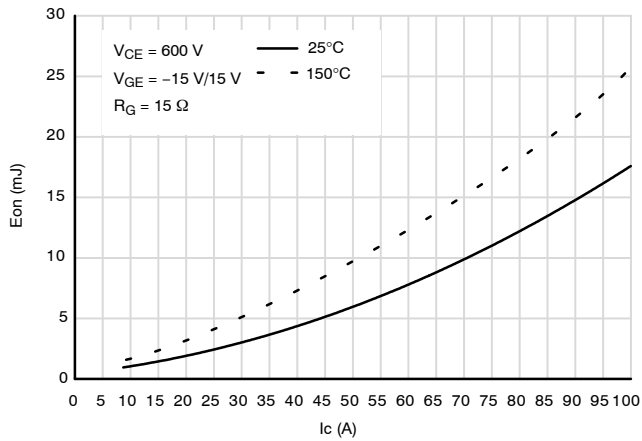

Figure 7. Inverter IGBT Typical Turn On Loss vs Ic

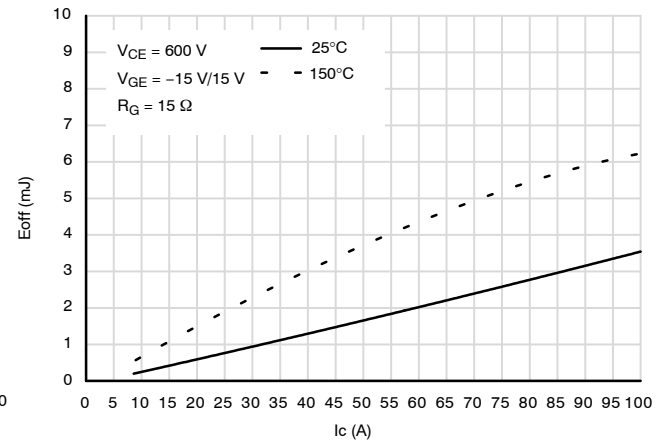

Figure 8. Inverter IGBT Typical Turn Off Loss vs Ic

NXH50C120L2C2ESG, NXH50C120L2C2ES1G

TYPICAL CHARACTERISTICS – INVERTER IGBT & INVERSE DIODE

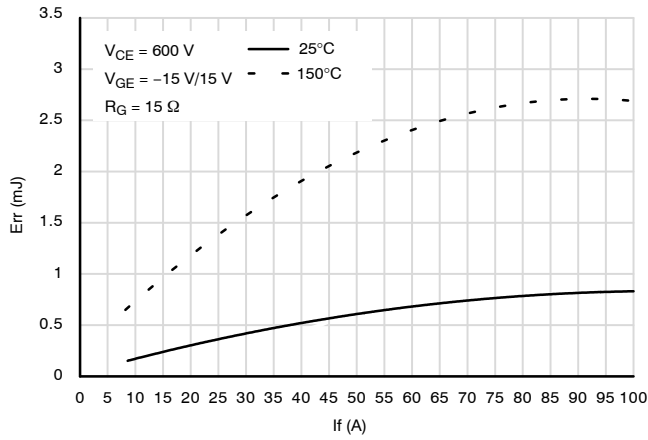

Figure 9. Inverter Diode Typical Reverse Recovery Energy vs IC

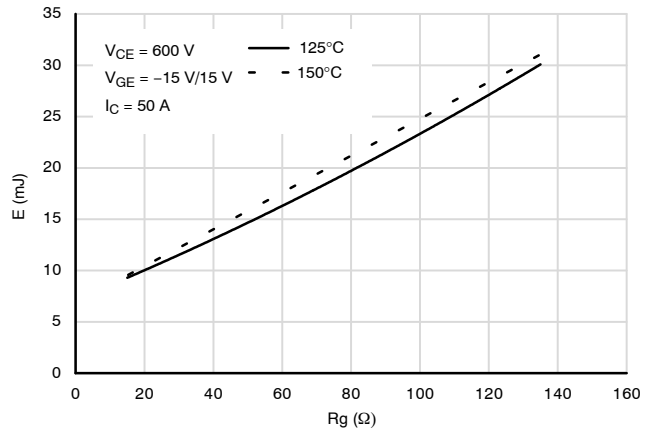

Figure 10. Inverter IGBT Typical Turn On Loss vs RG

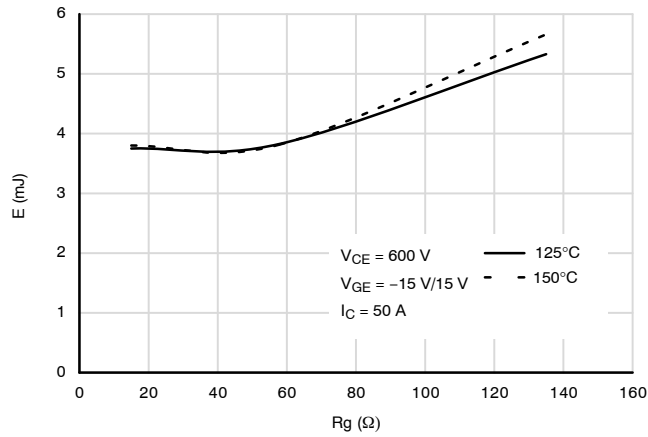

Figure 11. Inverter IGBT Typical Turn Off Loss vs RG

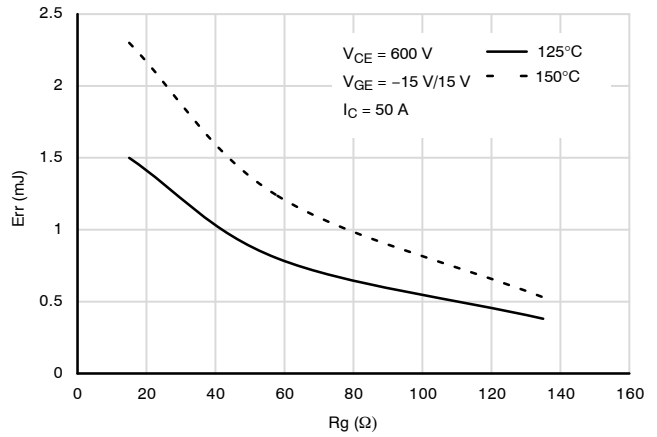

Figure 12. Inverter Diode Typical Reverse Recovery Energy vs RG

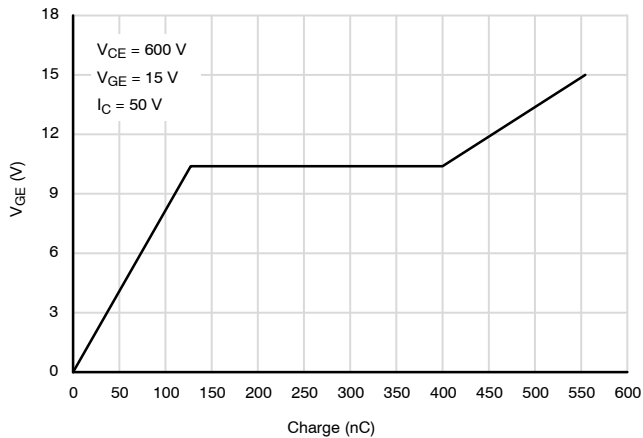

Figure 13. Inverter IGBT Gate Voltage vs Gate Charge

NXH50C120L2C2ESG, NXH50C120L2C2ES1G

TYPICAL CHARACTERISTICS – INVERTER IGBT & INVERSE DIODE

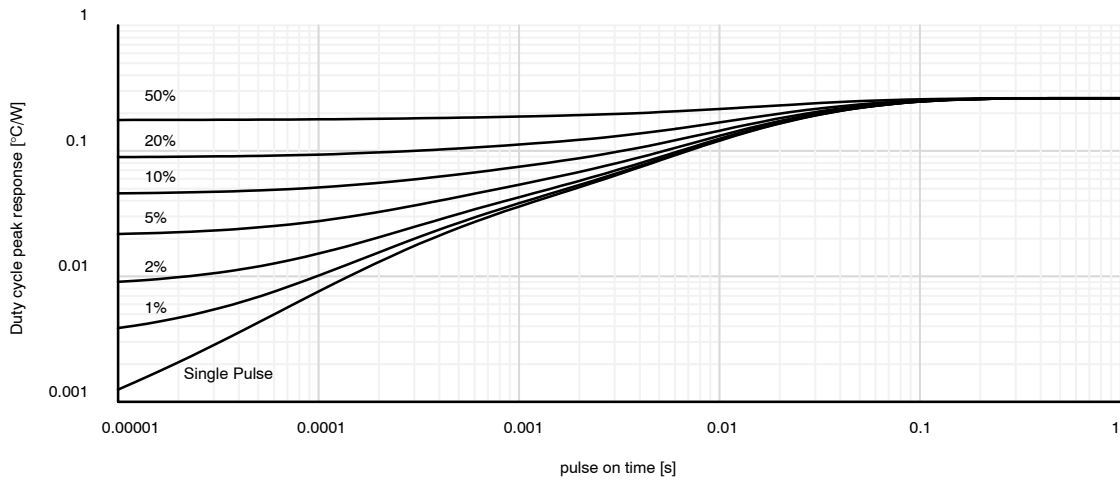

Figure 14. Inverter IGBT Junction-to-case Transient Thermal Impedance

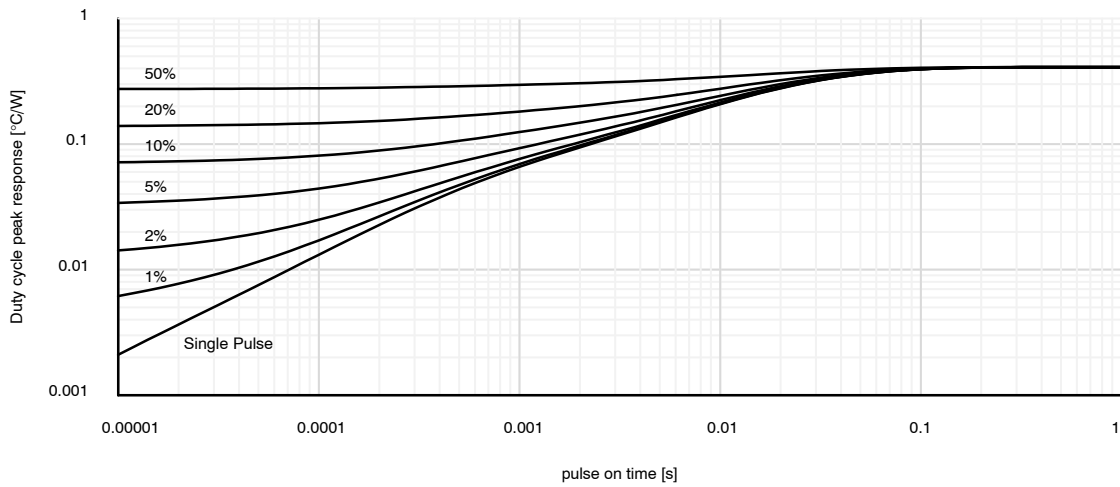

Figure 15. Inverter Diode Junction-to-case Transient Thermal Impedance

NXH50C120L2C2ESG, NXH50C120L2C2ES1G

TYPICAL CHARACTERISTICS – BRAKE IGBT & BRAKE DIODE

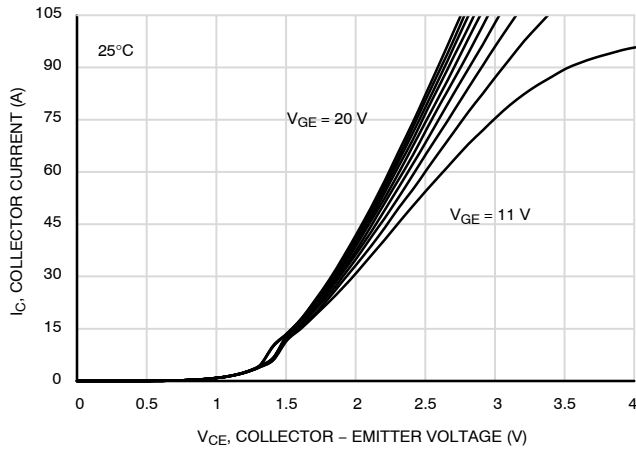

Figure 16. Brake IGBT Typical Output Characteristic (25°C)

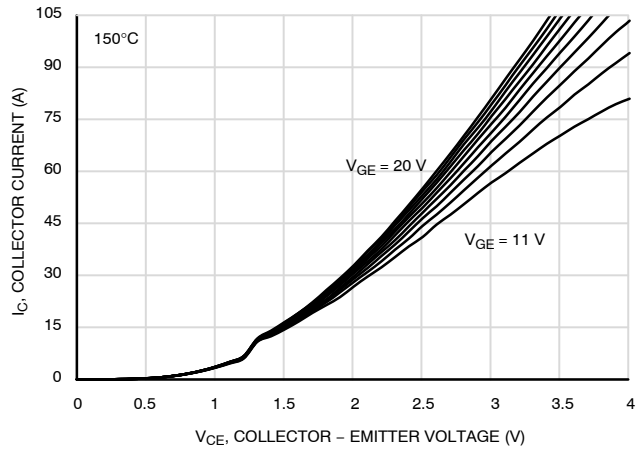

Figure 17. Brake IGBT Typical Output Characteristic (150°C)

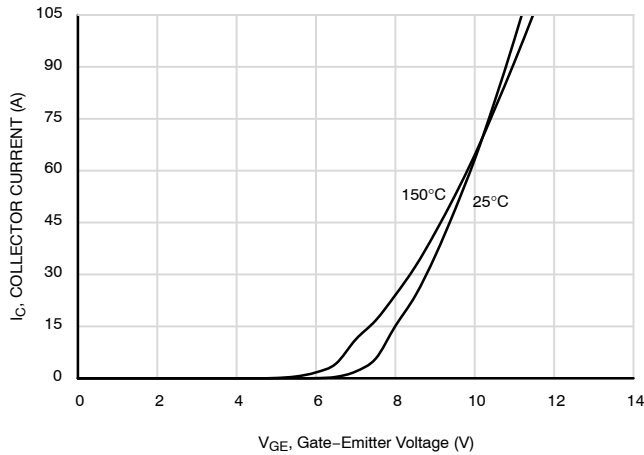

Figure 18. Brake IGBT Typical Transfer Characteristic

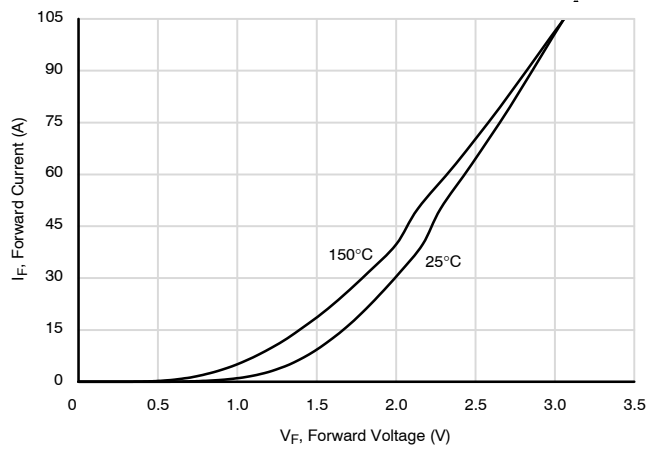

Figure 19. Brake Diode Typical Forward Characteristic

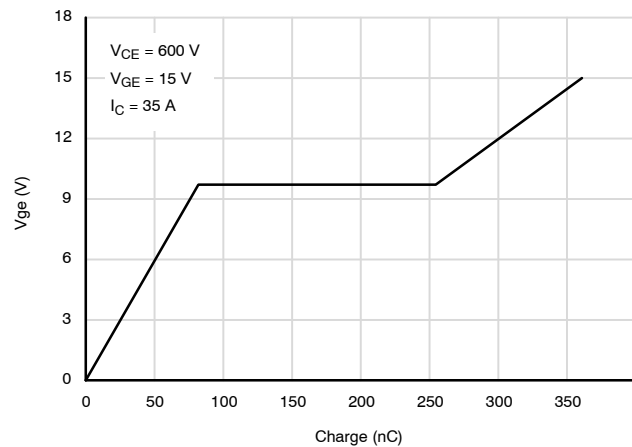

Figure 20. Brake IGBT Gate Voltage vs Gate Charge

NXH50C120L2C2ESG, NXH50C120L2C2ES1G

TYPICAL CHARACTERISTICS – RECTIFIER

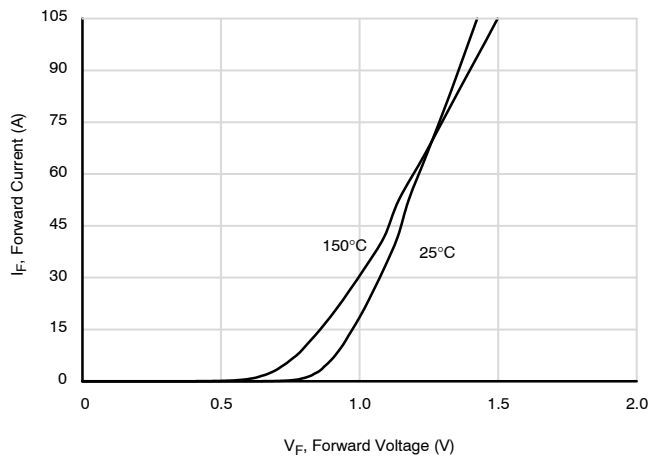

Figure 21. Rectifier Typical Forward Characteristic

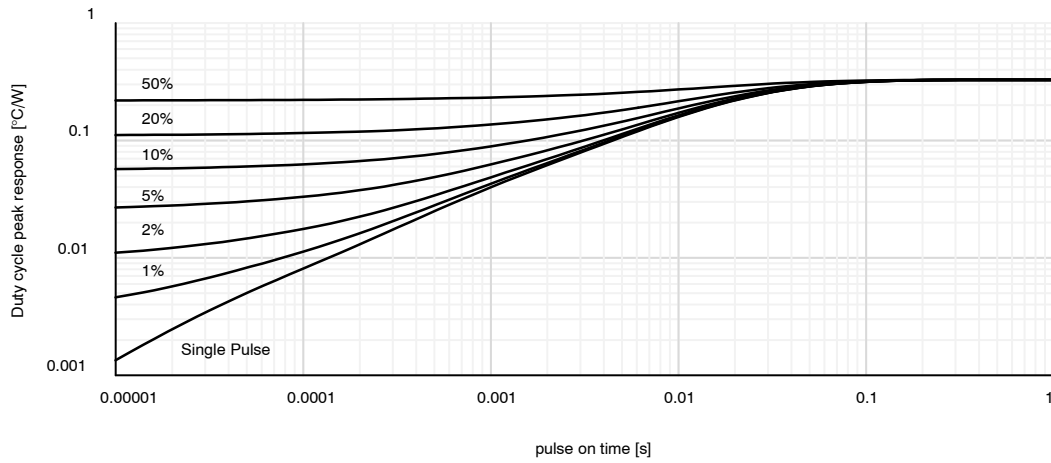
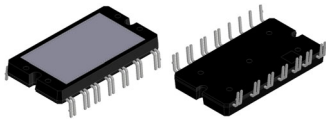

Figure 22. Rectifier Junction-to-Case Transient Thermal Impedance

MECHANICAL CASE OUTLINE

PACKAGE DIMENSIONS



DIP26 67.8x40
CASE 181AD
ISSUE B

DATE 05 AUG 2021

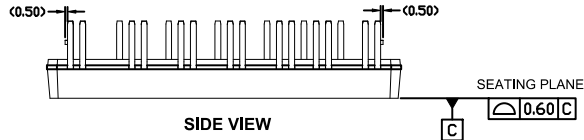

NOTES:

1. Dimensioning and tolerancing as per ASME Y14.5M, 2009
2. Controlling Dimension: Millimeters
3. Dimensions are exclusive of Burrs, Mold Flash, and Tiebar extrusions
4. Dimensions "b" and "c" apply to plated leads
5. Position of the leads is determine at the root of the lead where it exits the package body

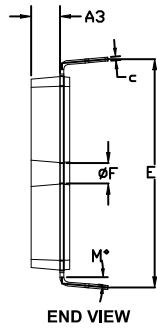
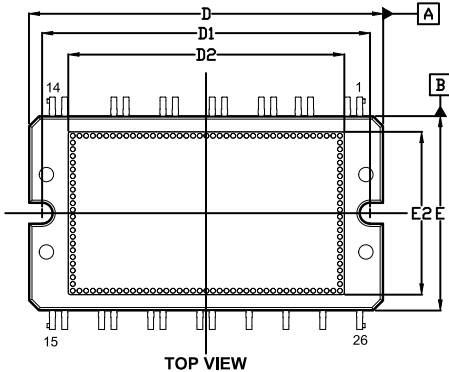

DIM	MILLIMETERS		
	MIN	NOM	MAX
A	15.50	16.00	16.50
A2	7.80	8.00	8.20
A3	6.00 REF		
b	1.10	1.20	1.30
c	0.70	0.80	0.90
D	72.70	73.20	73.70
D1	67.30	67.80	68.30
D2	57.30 REF		
E	39.70	40.20	40.70
E1	46.70	47.20	47.70
E2	33.87 REF		
e	2.54 BSC		
F	4.00	4.20	4.40
L	8.00 REF		
L1	3.50	4.00	4.50
M	4°	5°	6°

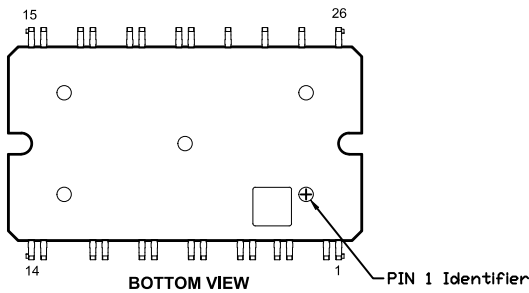
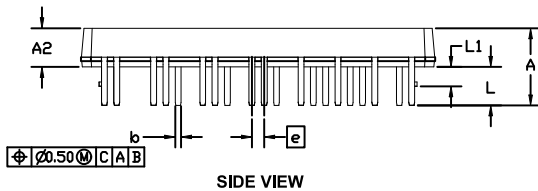

GENERIC MARKING DIAGRAM*

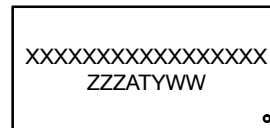

XXX = Specific Device Code
 ZZZ = Assembly Lot Code
 AT = Assembly & Test Location
 Y = Year
 WW = Work Week

*This information is generic. Please refer to device data sheet for actual part marking. Pb-Free indicator, "G" or microdot "▪", may or may not be present. Some products may not follow the Generic Marking.

DOCUMENT NUMBER:	98AON09519H	Electronic versions are uncontrolled except when accessed directly from the Document Repository. Printed versions are uncontrolled except when stamped "CONTROLLED COPY" in red.
DESCRIPTION:	DIP26 67.8x40	PAGE 1 OF 1

ON Semiconductor and are trademarks of Semiconductor Components Industries, LLC dba ON Semiconductor or its subsidiaries in the United States and/or other countries. ON Semiconductor reserves the right to make changes without further notice to any products herein. ON Semiconductor makes no warranty, representation or guarantee regarding the suitability of its products for any particular purpose, nor does ON Semiconductor assume any liability arising out of the application or use of any product or circuit, and specifically disclaims any and all liability, including without limitation special, consequential or incidental damages. ON Semiconductor does not convey any license under its patent rights nor the rights of others.

onsemi, **Onsemi**, and other names, marks, and brands are registered and/or common law trademarks of Semiconductor Components Industries, LLC dba "**onsemi**" or its affiliates and/or subsidiaries in the United States and/or other countries. **onsemi** owns the rights to a number of patents, trademarks, copyrights, trade secrets, and other intellectual property. A listing of **onsemi**'s product/patent coverage may be accessed at www.onsemi.com/site/pdf/Patent-Marking.pdf. **onsemi** reserves the right to make changes at any time to any products or information herein, without notice. The information herein is provided "as-is" and **onsemi** makes no warranty, representation or guarantee regarding the accuracy of the information, product features, availability, functionality, or suitability of its products for any particular purpose, nor does **onsemi** assume any liability arising out of the application or use of any product or circuit, and specifically disclaims any and all liability, including without limitation special, consequential or incidental damages. Buyer is responsible for its products and applications using **onsemi** products, including compliance with all laws, regulations and safety requirements or standards, regardless of any support or applications information provided by **onsemi**. "Typical" parameters which may be provided in **onsemi** data sheets and/or specifications can and do vary in different applications and actual performance may vary over time. All operating parameters, including "Typicals" must be validated for each customer application by customer's technical experts. **onsemi** does not convey any license under any of its intellectual property rights nor the rights of others. **onsemi** products are not designed, intended, or authorized for use as a critical component in life support systems or any FDA Class 3 medical devices or medical devices with a same or similar classification in a foreign jurisdiction or any devices intended for implantation in the human body. Should Buyer purchase or use **onsemi** products for any such unintended or unauthorized application, Buyer shall indemnify and hold **onsemi** and its officers, employees, subsidiaries, affiliates, and distributors harmless against all claims, costs, damages, and expenses, and reasonable attorney fees arising out of, directly or indirectly, any claim of personal injury or death associated with such unintended or unauthorized use, even if such claim alleges that **onsemi** was negligent regarding the design or manufacture of the part. **onsemi** is an Equal Opportunity/Affirmative Action Employer. This literature is subject to all applicable copyright laws and is not for resale in any manner.

PUBLICATION ORDERING INFORMATION

LITERATURE FULFILLMENT:

Email Requests to: orderlit@onsemi.com

onsemi Website: www.onsemi.com

TECHNICAL SUPPORT

North American Technical Support:

Voice Mail: 1 800-282-9855 Toll Free USA/Canada

Phone: 011 421 33 790 2910

Europe, Middle East and Africa Technical Support:

Phone: 00421 33 790 2910

For additional information, please contact your local Sales Representative