

MUN2214, MMUN2214L, MUN5214, DTC114YE, DTC114YM3, NSBC114YF3

Digital Transistors (BRT) R1 = 10 kΩ, R2 = 47 kΩ

NPN Transistors with Monolithic Bias Resistor Network

This series of digital transistors is designed to replace a single device and its external resistor bias network. The Bias Resistor Transistor (BRT) contains a single transistor with a monolithic bias network consisting of two resistors; a series base resistor and a base-emitter resistor. The BRT eliminates these individual components by integrating them into a single device. The use of a BRT can reduce both system cost and board space.

Features

- Simplifies Circuit Design
- Reduces Board Space
- Reduces Component Count
- S and NSV Prefix for Automotive and Other Applications Requiring Unique Site and Control Change Requirements; AEC-Q101 Qualified and PPAP Capable
- These Devices are Pb-Free, Halogen Free/BFR Free and are RoHS Compliant

MAXIMUM RATINGS (T_A = 25°C)

Rating	Symbol	Max	Unit
Collector-Base Voltage	V _{CBO}	50	Vdc
Collector-Emitter Voltage	V _{CEO}	50	Vdc
Collector Current - Continuous	I _C	100	mAdc
Input Forward Voltage	V _{IN(fwd)}	40	Vdc
Input Reverse Voltage	V _{IN(rev)}	6	Vdc

Stresses exceeding Maximum Ratings may damage the device. Maximum Ratings are stress ratings only. Functional operation above the Recommended Operating Conditions is not implied. Extended exposure to stresses above the Recommended Operating Conditions may affect device reliability.



ON Semiconductor®

<http://onsemi.com>

PIN CONNECTIONS

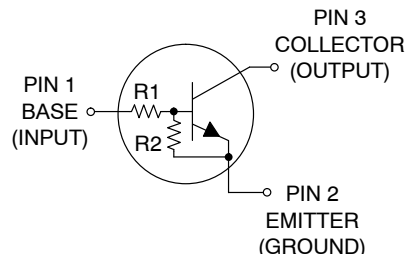

MARKING DIAGRAMS

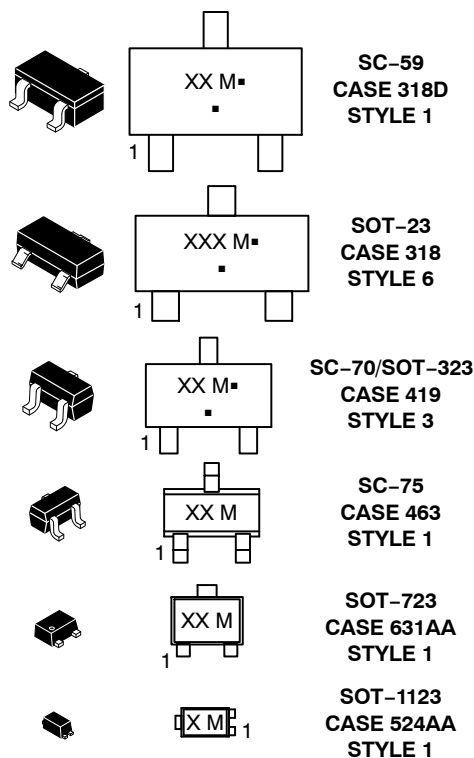

XXX = Specific Device Code
M = Date Code*
▪ = Pb-Free Package

(Note: Microdot may be in either location)

*Date Code orientation may vary depending upon manufacturing location.

ORDERING INFORMATION

See detailed ordering, marking, and shipping information in the package dimensions section on page 2 of this data sheet.

MUN2214, MMUN2214L, MUN5214, DTC114YE, DTC114YM3, NSBC114YF3

Table 1. ORDERING INFORMATION

Device	Part Marking	Package	Shipping†
MUN2214T1G, SMUN2214T1G	8D	SC-59 (Pb-Free)	3,000 / Tape & Reel
MUN2214T3G, SMUN2214T3G	8D	SC-59 (Pb-Free)	10,000 / Tape & Reel
MMUN2214LT1G, SMMUN2214LT1G	A8D	SOT-23 (Pb-Free)	3,000 / Tape & Reel
MUN5214T1G, SMUN5214T1G	8D	SC-70/SOT-323 (Pb-Free)	10,000 / Tape & Reel
DTC114YET1G, SDTC114YET1G	8D	SC-75 (Pb-Free)	3,000 / Tape & Reel
DTC114YM3T5G	8D	SOT-723 (Pb-Free)	10,000 / Tape & Reel
NSBC114YF3T5G	J	SOT-1123 (Pb-Free)	3,000 / Tape & Reel

†For information on tape and reel specifications, including part orientation and tape sizes, please refer to our Tape and Reel Packaging Specifications Brochure, BRD8011/D.

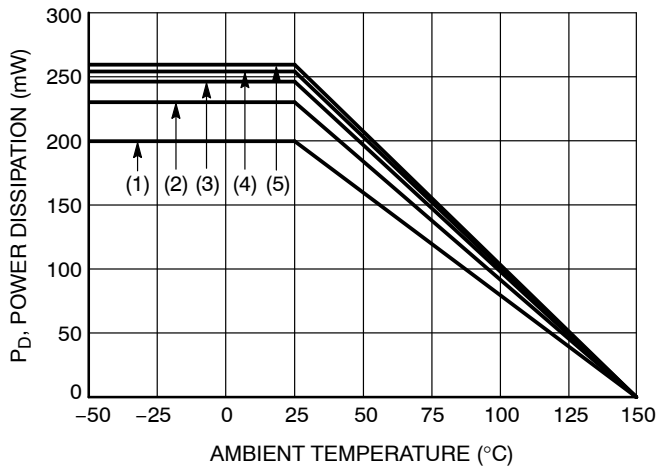

- (1) SC-75 and SC-70/SOT-323; Minimum Pad
- (2) SC-59; Minimum Pad
- (3) SOT-23; Minimum Pad
- (4) SOT-1123; 100 mm², 1 oz. copper trace
- (5) SOT-723; Minimum Pad

Figure 1. Derating Curve

MUN2214, MMUN2214L, MUN5214, DTC114YE, DTC114YM3, NSBC114YF3

Table 2. THERMAL CHARACTERISTICS

Characteristic	Symbol	Max	Unit
THERMAL CHARACTERISTICS (SC-59) (MUN2214)			
Total Device Dissipation $T_A = 25^\circ\text{C}$	P_D	230	mW
Derate above 25°C		338	$\text{mW}/^\circ\text{C}$
		1.8	
		2.7	
Thermal Resistance, Junction to Ambient	$R_{\theta JA}$	540	$^\circ\text{C}/\text{W}$
		370	
Thermal Resistance, Junction to Lead	$R_{\theta JL}$	264	$^\circ\text{C}/\text{W}$
		287	
Junction and Storage Temperature Range	T_J, T_{stg}	-55 to +150	$^\circ\text{C}$
THERMAL CHARACTERISTICS (SOT-23) (MUNN2214L)			
Total Device Dissipation $T_A = 25^\circ\text{C}$	P_D	246	mW
Derate above 25°C		400	$\text{mW}/^\circ\text{C}$
		2.0	
		3.2	
Thermal Resistance, Junction to Ambient	$R_{\theta JA}$	508	$^\circ\text{C}/\text{W}$
		311	
Thermal Resistance, Junction to Lead	$R_{\theta JL}$	174	$^\circ\text{C}/\text{W}$
		208	
Junction and Storage Temperature Range	T_J, T_{stg}	-55 to +150	$^\circ\text{C}$
THERMAL CHARACTERISTICS (SC-70/SOT-323) (MUN5214)			
Total Device Dissipation $T_A = 25^\circ\text{C}$	P_D	202	mW
Derate above 25°C		310	$\text{mW}/^\circ\text{C}$
		1.6	
		2.5	
Thermal Resistance, Junction to Ambient	$R_{\theta JA}$	618	$^\circ\text{C}/\text{W}$
		403	
Thermal Resistance, Junction to Lead	$R_{\theta JL}$	280	$^\circ\text{C}/\text{W}$
		332	
Junction and Storage Temperature Range	T_J, T_{stg}	-55 to +150	$^\circ\text{C}$
THERMAL CHARACTERISTICS (SC-75) (DTC114YE)			
Total Device Dissipation $T_A = 25^\circ\text{C}$	P_D	200	mW
Derate above 25°C		300	$\text{mW}/^\circ\text{C}$
		1.6	
		2.4	
Thermal Resistance, Junction to Ambient	$R_{\theta JA}$	600	$^\circ\text{C}/\text{W}$
		400	
Junction and Storage Temperature Range	T_J, T_{stg}	-55 to +150	$^\circ\text{C}$
THERMAL CHARACTERISTICS (SOT-723) (DTC114YM3)			
Total Device Dissipation $T_A = 25^\circ\text{C}$	P_D	260	mW
Derate above 25°C		600	$\text{mW}/^\circ\text{C}$
		2.0	
		4.8	
Thermal Resistance, Junction to Ambient	$R_{\theta JA}$	480	$^\circ\text{C}/\text{W}$
		205	
Junction and Storage Temperature Range	T_J, T_{stg}	-55 to +150	$^\circ\text{C}$

- FR-4 @ Minimum Pad.
- FR-4 @ 1.0 x 1.0 Inch Pad.
- FR-4 @ 100 mm², 1 oz. copper traces, still air.
- FR-4 @ 500 mm², 1 oz. copper traces, still air.

MUN2214, MMUN2214L, MUN5214, DTC114YE, DTC114YM3, NSBC114YF3

Table 2. THERMAL CHARACTERISTICS

Characteristic	Symbol	Max	Unit
THERMAL CHARACTERISTICS (SOT-1123) (NSBC114YF3)			
Total Device Dissipation $T_A = 25^\circ\text{C}$ Derate above 25°C	P_D (Note 3) (Note 4) (Note 3) (Note 4)	254 297 2.0 2.4	mW mW/ $^\circ\text{C}$
Thermal Resistance, Junction to Ambient	$R_{\theta JA}$ (Note 3) (Note 4)	493 421	$^\circ\text{C}/\text{W}$
Thermal Resistance, Junction to Lead	$R_{\theta JL}$ (Note 3)	193	$^\circ\text{C}/\text{W}$
Junction and Storage Temperature Range	T_J, T_{stg}	-55 to +150	$^\circ\text{C}$

1. FR-4 @ Minimum Pad.
2. FR-4 @ 1.0 x 1.0 Inch Pad.
3. FR-4 @ 100 mm², 1 oz. copper traces, still air.
4. FR-4 @ 500 mm², 1 oz. copper traces, still air.

Table 3. ELECTRICAL CHARACTERISTICS ($T_A = 25^\circ\text{C}$, unless otherwise noted)

Characteristic	Symbol	Min	Typ	Max	Unit
OFF CHARACTERISTICS					
Collector-Base Cutoff Current ($V_{CB} = 50\text{ V}, I_E = 0$)	I_{CBO}	-	-	100	nAdc
Collector-Emitter Cutoff Current ($V_{CE} = 50\text{ V}, I_B = 0$)	I_{CEO}	-	-	500	nAdc
Emitter-Base Cutoff Current ($V_{EB} = 6.0\text{ V}, I_C = 0$)	I_{EBO}	-	-	0.2	mAdc
Collector-Base Breakdown Voltage ($I_C = 10\ \mu\text{A}, I_E = 0$)	$V_{(BR)CBO}$	50	-	-	Vdc
Collector-Emitter Breakdown Voltage (Note 5) ($I_C = 2.0\text{ mA}, I_B = 0$)	$V_{(BR)CEO}$	50	-	-	Vdc
ON CHARACTERISTICS					
DC Current Gain (Note 5) ($I_C = 5.0\text{ mA}, V_{CE} = 10\text{ V}$)	h_{FE}	80	140	-	
Collector - Emitter Saturation Voltage (Note 5) ($I_C = 10\text{ mA}, I_B = 0.3\text{ mA}$)	$V_{CE(sat)}$	-	-	0.25	Vdc
Input Voltage (off) ($V_{CE} = 5.0\text{ V}, I_C = 100\ \mu\text{A}$)	$V_{i(off)}$	-	0.7	-	Vdc
Input Voltage (on) ($V_{CE} = 0.2\text{ V}, I_C = 1.0\text{ mA}$)	$V_{i(on)}$	-	0.8	-	Vdc
Output Voltage (on) ($V_{CC} = 5.0\text{ V}, V_B = 2.5\text{ V}, R_L = 1.0\text{ k}\Omega$)	V_{OL}	-	-	0.2	Vdc
Output Voltage (off) ($V_{CC} = 5.0\text{ V}, V_B = 0.5\text{ V}, R_L = 1.0\text{ k}\Omega$)	V_{OH}	4.9	-	-	Vdc
Input Resistor	R1	7.0	10	13	k Ω
Resistor Ratio	R_1/R_2	0.17	0.21	0.25	

5. Pulsed Condition: Pulse Width = 300 msec, Duty Cycle \leq 2%.

TYPICAL CHARACTERISTICS
MUN2214, MMUN2214L, MUN5214, DTC114YE, DTC114YM3

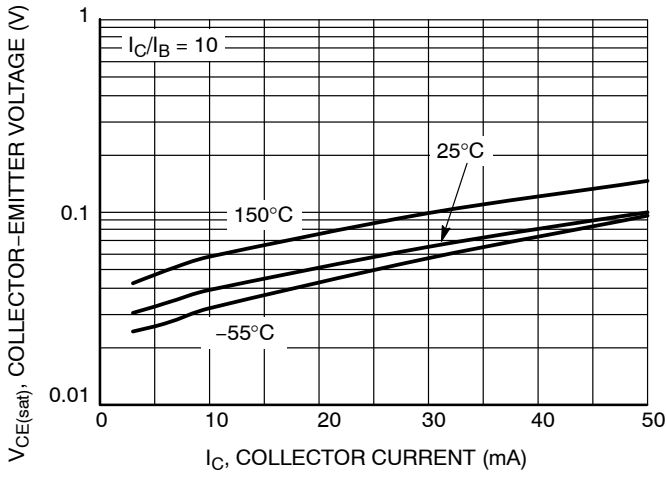

Figure 2. $V_{CE(sat)}$ vs. I_C

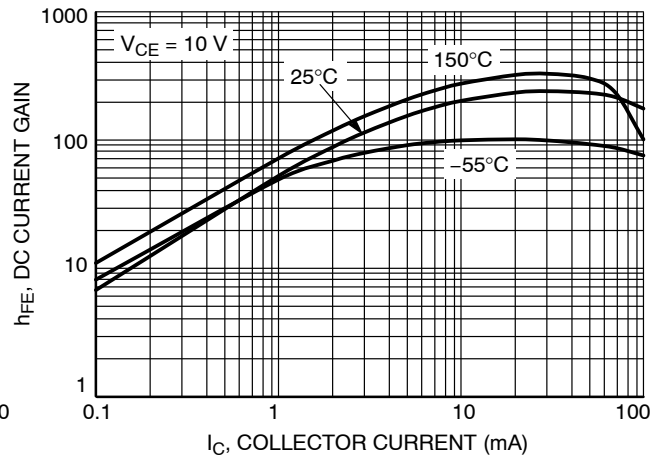

Figure 3. DC Current Gain

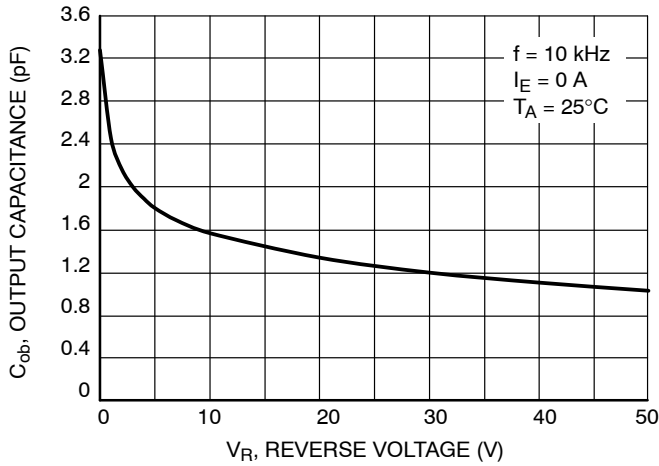

Figure 4. Output Capacitance

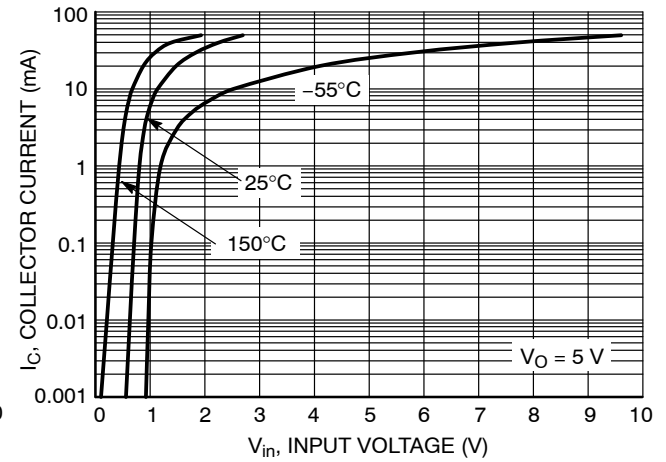

Figure 5. Output Current vs. Input Voltage

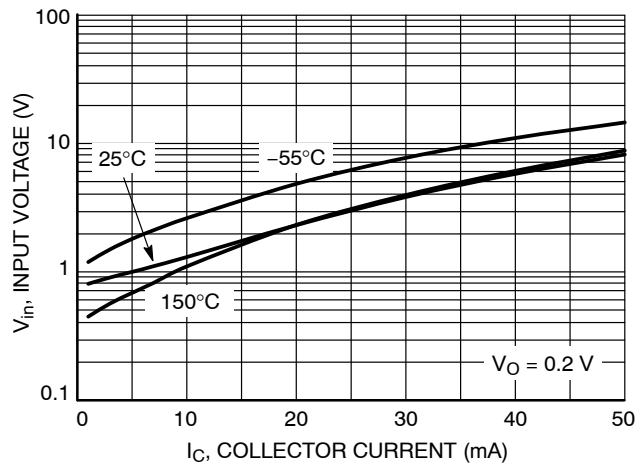

Figure 6. Input Voltage vs. Output Current

TYPICAL CHARACTERISTICS
NSBC114YF3

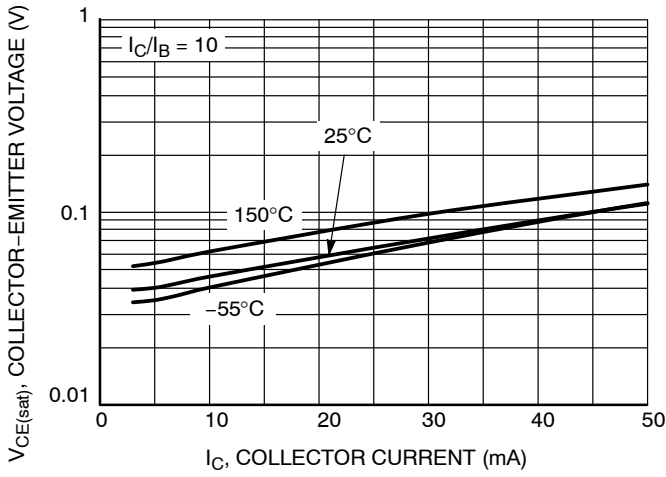

Figure 7. $V_{CE(sat)}$ vs. I_C

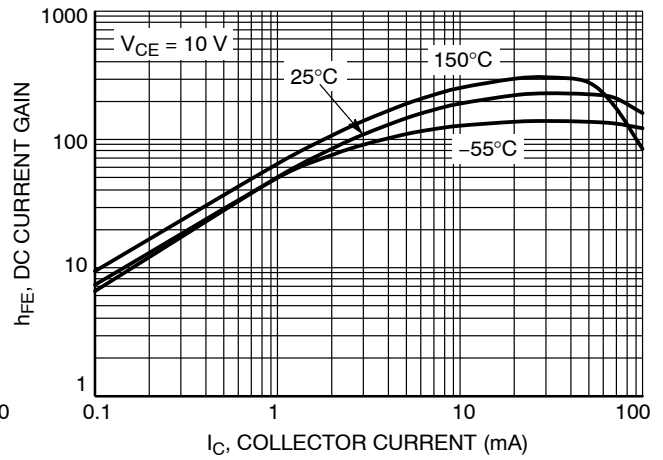

Figure 8. DC Current Gain

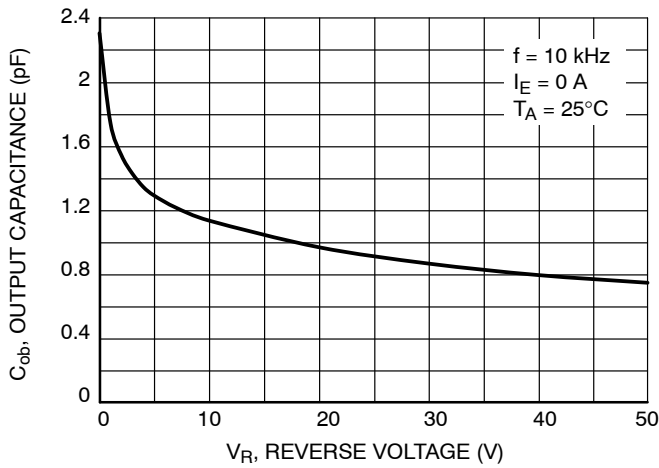

Figure 9. Output Capacitance

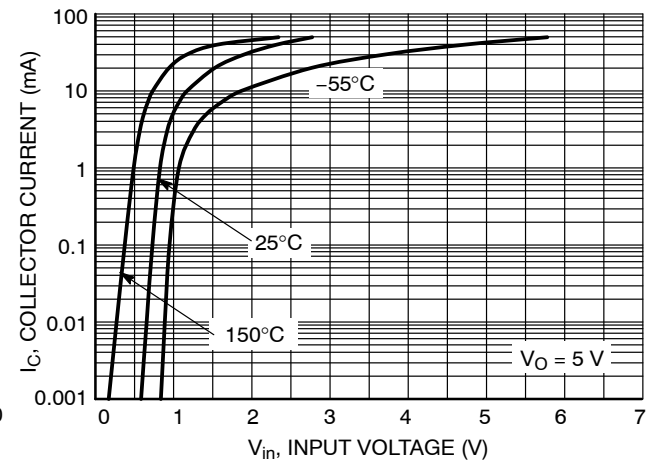

Figure 10. Output Current vs. Input Voltage

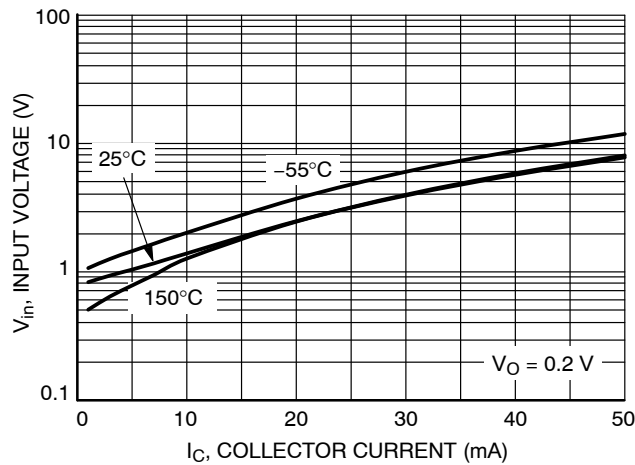
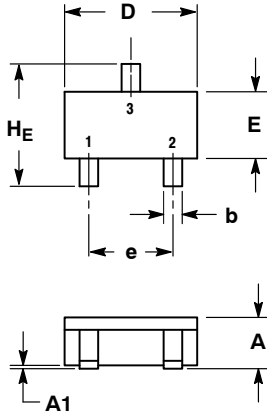

Figure 11. Input Voltage vs. Output Current

PACKAGE DIMENSIONS

SC-59
CASE 318D-04
ISSUE H

NOTES:
1. DIMENSIONING AND TOLERANCING PER ANSI Y14.5M, 1982.
2. CONTROLLING DIMENSION: MILLIMETER.



DIM	MILLIMETERS			INCHES		
	MIN	NOM	MAX	MIN	NOM	MAX
A	1.00	1.15	1.30	0.039	0.045	0.051
A1	0.01	0.06	0.10	0.001	0.002	0.004
b	0.35	0.43	0.50	0.014	0.017	0.020
c	0.09	0.14	0.18	0.003	0.005	0.007
D	2.70	2.90	3.10	0.106	0.114	0.122
E	1.30	1.50	1.70	0.051	0.059	0.067
e	1.70	1.90	2.10	0.067	0.075	0.083
L	0.20	0.40	0.60	0.008	0.016	0.024
HE	2.50	2.80	3.00	0.099	0.110	0.118

STYLE 1:
PIN 1. BASE
2. EMITTER
3. COLLECTOR

SOLDERING FOOTPRINT*

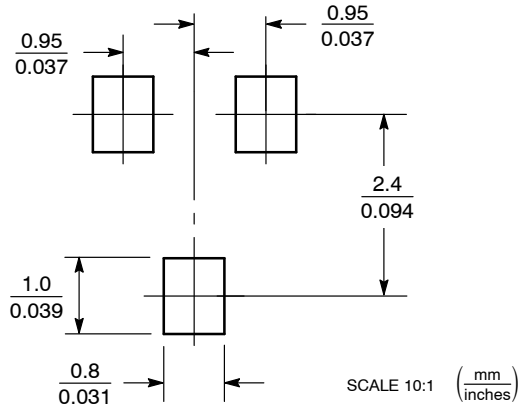

*For additional information on our Pb-Free strategy and soldering details, please download the ON Semiconductor Soldering and Mounting Techniques Reference Manual, SOLDERRM/D.

PACKAGE DIMENSIONS

SOT-23 (TO-236)
CASE 318-08
ISSUE AP

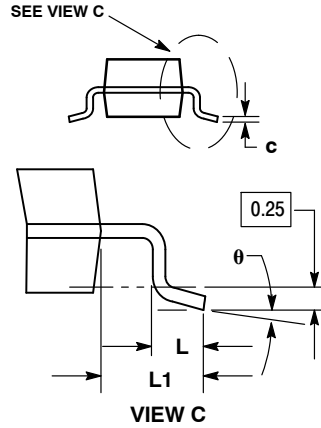

- NOTES:
1. DIMENSIONING AND TOLERANCING PER ANSI Y14.5M, 1982.
 2. CONTROLLING DIMENSION: INCH.
 3. MAXIMUM LEAD THICKNESS INCLUDES LEAD FINISH THICKNESS. MINIMUM LEAD THICKNESS IS THE MINIMUM THICKNESS OF BASE MATERIAL.
 4. DIMENSIONS D AND E DO NOT INCLUDE MOLD FLASH, PROTRUSIONS, OR GATE BURRS.

DIM	MILLIMETERS			INCHES		
	MIN	NOM	MAX	MIN	NOM	MAX
A	0.89	1.00	1.11	0.035	0.040	0.044
A1	0.01	0.06	0.10	0.001	0.002	0.004
b	0.37	0.44	0.50	0.015	0.018	0.020
c	0.09	0.13	0.18	0.003	0.005	0.007
D	2.80	2.90	3.04	0.110	0.114	0.120
E	1.20	1.30	1.40	0.047	0.051	0.055
e	1.78	1.90	2.04	0.070	0.075	0.081
L	0.10	0.20	0.30	0.004	0.008	0.012
L1	0.35	0.54	0.69	0.014	0.021	0.029
HE	2.10	2.40	2.64	0.083	0.094	0.104
θ	0°	---	10°	0°	---	10°

STYLE 6:
PIN 1. BASE
2. EMITTER
3. COLLECTOR

SOLDERING FOOTPRINT*

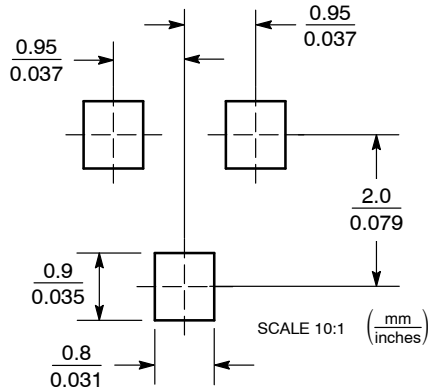

*For additional information on our Pb-Free strategy and soldering details, please download the ON Semiconductor Soldering and Mounting Techniques Reference Manual, SOLDERRM/D.

PACKAGE DIMENSIONS

SC-70 (SOT-323)
CASE 419-04
ISSUE N

NOTES:
1. DIMENSIONING AND TOLERANCING PER ANSI Y14.5M, 1982.
2. CONTROLLING DIMENSION: INCH.



DIM	MILLIMETERS			INCHES		
	MIN	NOM	MAX	MIN	NOM	MAX
A	0.80	0.90	1.00	0.032	0.035	0.040
A1	0.00	0.05	0.10	0.000	0.002	0.004
A2	0.70 REF			0.028 REF		
b	0.30	0.35	0.40	0.012	0.014	0.016
c	0.10	0.18	0.25	0.004	0.007	0.010
D	1.80	2.10	2.20	0.071	0.083	0.087
E	1.15	1.24	1.35	0.045	0.049	0.053
e	1.20	1.30	1.40	0.047	0.051	0.055
e1	0.65 BSC			0.026 BSC		
L	0.20	0.38	0.56	0.008	0.015	0.022
HE	2.00	2.10	2.40	0.079	0.083	0.095

STYLE 3:
PIN 1: BASE
2: EMITTER
3: COLLECTOR

SOLDERING FOOTPRINT*



*For additional information on our Pb-Free strategy and soldering details, please download the ON Semiconductor Soldering and Mounting Techniques Reference Manual, SOLDERRM/D.

PACKAGE DIMENSIONS

SC-75/SOT-416
CASE 463
ISSUE F

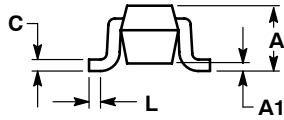
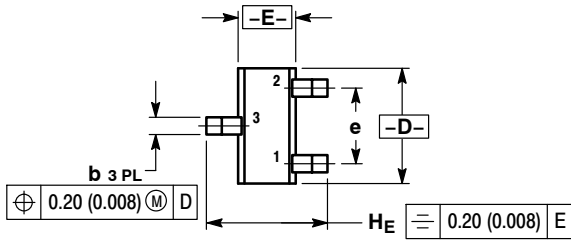

- NOTES:
1. DIMENSIONING AND TOLERANCING PER ANSI Y14.5M, 1982.
2. CONTROLLING DIMENSION: MILLIMETER.

DIM	MILLIMETERS			INCHES		
	MIN	NOM	MAX	MIN	NOM	MAX
A	0.70	0.80	0.90	0.027	0.031	0.035
A1	0.00	0.05	0.10	0.000	0.002	0.004
b	0.15	0.20	0.30	0.006	0.008	0.012
C	0.10	0.15	0.25	0.004	0.006	0.010
D	1.55	1.60	1.65	0.059	0.063	0.067
E	0.70	0.80	0.90	0.027	0.031	0.035
e	1.00 BSC			0.04 BSC		
L	0.10	0.15	0.20	0.004	0.006	0.008
HE	1.50	1.60	1.70	0.061	0.063	0.065

- STYLE 1:
PIN 1. BASE
2. EMITTER
3. COLLECTOR

SOLDERING FOOTPRINT*



SCALE 10:1 (mm/inches)

*For additional information on our Pb-Free strategy and soldering details, please download the ON Semiconductor Soldering and Mounting Techniques Reference Manual, SOLDERRM/D.

PACKAGE DIMENSIONS

SOT-723
CASE 631AA-01
ISSUE D

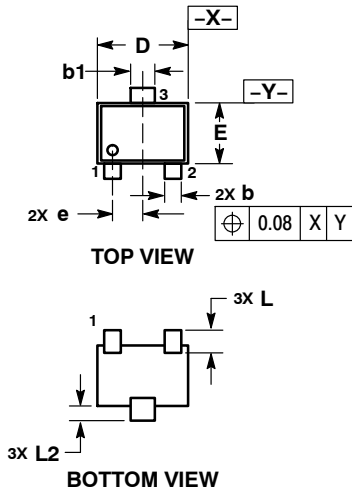

- NOTES:
1. DIMENSIONING AND TOLERANCING PER ASME Y14.5M, 1994.
 2. CONTROLLING DIMENSION: MILLIMETERS.
 3. MAXIMUM LEAD THICKNESS INCLUDES LEAD FINISH. MINIMUM LEAD THICKNESS IS THE MINIMUM THICKNESS OF BASE MATERIAL.
 4. DIMENSIONS D AND E DO NOT INCLUDE MOLD FLASH, PROTRUSIONS OR GATE BURRS.

DIM	MILLIMETERS		
	MIN	NOM	MAX
A	0.45	0.50	0.55
b	0.15	0.21	0.27
b1	0.25	0.31	0.37
C	0.07	0.12	0.17
D	1.15	1.20	1.25
E	0.75	0.80	0.85
e	0.40 BSC		
H _E	1.15	1.20	1.25
L	0.29 REF		
L2	0.15	0.20	0.25

- STYLE 1:
PIN 1. BASE
2. EMITTER
3. COLLECTOR

RECOMMENDED
SOLDERING FOOTPRINT*



*For additional information on our Pb-Free strategy and soldering details, please download the ON Semiconductor Soldering and Mounting Techniques Reference Manual, SOLDERRM/D.

PACKAGE DIMENSIONS

SOT-1123
CASE 524AA
ISSUE C

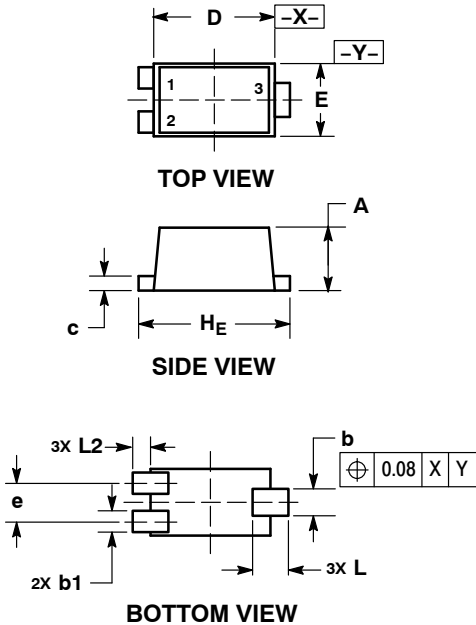

- NOTES:
1. DIMENSIONING AND TOLERANCING PER ASME Y14.5M, 1994.
 2. CONTROLLING DIMENSION: MILLIMETERS.
 3. MAXIMUM LEAD THICKNESS INCLUDES LEAD FINISH. MINIMUM LEAD THICKNESS IS THE MINIMUM THICKNESS OF BASE MATERIAL.
 4. DIMENSIONS D AND E DO NOT INCLUDE MOLD FLASH, PROTRUSIONS, OR GATE BURRS.

DIM	MILLIMETERS	
	MIN	MAX
A	0.34	0.40
b	0.15	0.28
b1	0.10	0.20
c	0.07	0.17
D	0.75	0.85
E	0.55	0.65
e	0.35	0.40
H _E	0.95	1.05
L	0.185	REF
L ₂	0.05	0.15

- STYLE 1:
1. BASE
 2. EMITTER
 3. COLLECTOR

SOLDERING FOOTPRINT*

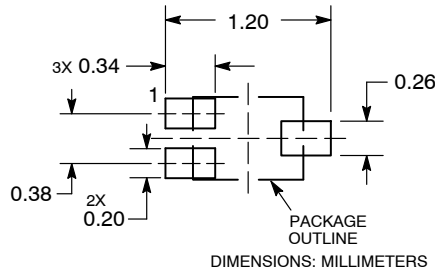

*For additional information on our Pb-Free strategy and soldering details, please download the ON Semiconductor Soldering and Mounting Techniques Reference Manual, SOLDERRM/D.

ON Semiconductor and are registered trademarks of Semiconductor Components Industries, LLC (SCILLC). SCILLC owns the rights to a number of patents, trademarks, copyrights, trade secrets, and other intellectual property. A listing of SCILLC's product/patent coverage may be accessed at www.onsemi.com/site/pdf/Patent-Marking.pdf. SCILLC reserves the right to make changes without further notice to any products herein. SCILLC makes no warranty, representation or guarantee regarding the suitability of its products for any particular purpose, nor does SCILLC assume any liability arising out of the application or use of any product or circuit, and specifically disclaims any and all liability, including without limitation special, consequential or incidental damages. "Typical" parameters which may be provided in SCILLC data sheets and/or specifications can and do vary in different applications and actual performance may vary over time. All operating parameters, including "Typicals" must be validated for each customer application by customer's technical experts. SCILLC does not convey any license under its patent rights nor the rights of others. SCILLC products are not designed, intended, or authorized for use as components in systems intended for surgical implant into the body, or other applications intended to support or sustain life, or for any other application in which the failure of the SCILLC product could create a situation where personal injury or death may occur. Should Buyer purchase or use SCILLC products for any such unintended or unauthorized application, Buyer shall indemnify and hold SCILLC and its officers, employees, subsidiaries, affiliates, and distributors harmless against all claims, costs, damages, and expenses, and reasonable attorney fees arising out of, directly or indirectly, any claim of personal injury or death associated with such unintended or unauthorized use, even if such claim alleges that SCILLC was negligent regarding the design or manufacture of the part. SCILLC is an Equal Opportunity/Affirmative Action Employer. This literature is subject to all applicable copyright laws and is not for resale in any manner.

PUBLICATION ORDERING INFORMATION

LITERATURE FULFILLMENT:
Literature Distribution Center for ON Semiconductor
P.O. Box 5163, Denver, Colorado 80217 USA
Phone: 303-675-2175 or 800-344-3860 Toll Free USA/Canada
Fax: 303-675-2176 or 800-344-3867 Toll Free USA/Canada
Email: orderlit@onsemi.com

N. American Technical Support: 800-282-9855 Toll Free
USA/Canada
Europe, Middle East and Africa Technical Support:
Phone: 421 33 790 2910
Japan Customer Focus Center
Phone: 81-3-5817-1050

ON Semiconductor Website: www.onsemi.com
Order Literature: <http://www.onsemi.com/orderlit>
For additional information, please contact your local Sales Representative