

Specifications Common to All

A22/M22

The Following Pages Provide Information Common To Each Model of The A22/M22 Pushbutton Switch

- A22
- A22S/W
- A22K
- M22

Specifications

■ APPROVED STANDARDS

Recognized organization	Standards	File No.
UL, cUL (See note)	UL508	E41515
ASTA	EN60947-5-1	—

Note: UL: CSA C22 No. 14

■ RATINGS

Contacts (General-purpose Load)

Rated carry current	Rated voltage	Rated current (A)			
		Utilization category			
		AC15 (inductive load)	AC12 (resistive load)	DC13 (inductive load)	DC12 (resistive load)
10 amps	24 VAC	10	10	—	—
	110 VAC	5	10	—	—
	220 VAC	3	6	—	—
	380 VAC	2	3	—	—
	440 VAC	1	2	—	—
	24 VDC	—	—	1.5	10
	110 VDC	—	—	0.5	2
	220 VDC	—	—	0.2	0.6
380 VDC	—	—	0.1	0.2	

Note: 1. Rated current values are determined according to the testing conditions specified by JIS C4520. The above ratings were obtained by conducting tests under the following conditions as specified by JIS C4505.

- (1) Ambient temperature: 20°±2°C
- (2) Ambient humidity: 65±5%
- (3) Operating frequency: 20 operations/min

2. Minimum applied load: 10 mA, 5 VDC

Contacts (Microload)

Rated applied load	Minimum applied load
50 mA, 5 VDC (Resistive load)	1 mA, 5 VDC

LED Indicators without Transformer

Rated voltage	Rated current	Operating voltage
6 VDC	60 mA	6 VDC±5%
6 VAC	60 mA	6 VAC/DC±5%
12 VAC/DC	30 mA	12 VAC/DC±5%
24 VAC/DC	15 mA	24 VAC/DC±5%

Incandescent Lamp

Rated voltage	Rated current	Operating voltage
6 VDC	200 mA	5 V
14 VAC/DC	80 mA	12 V
28 VAC/DC	40 mA	24 V
130 VAC/DC	20 mA	100 V

Transformer Lighting

Rated voltage	Operational voltage	Applicable lamp (BA8S/13□ gold)
110 VAC	95 to 115 VAC	LED Lamp (A22-24A□)
220 VAC	190 to 230 VAC	

■ CHARACTERISTICS

Item		Pushbutton switches		Emergency stop switches		Knob-type selector switches		Key-type selector switch
		Non-illuminated models: A22-F, A22-T, A22-G, A22-S, A22-C, A22-D, A22-H, A22-M	Illuminated models: A22L-T, A22L-G, A22L-H, A22L-D, A22L-C	Non-illuminated models: A22E	Illuminated models: A22EL	Non-illuminated models: A22S	Illuminated models: A22W	Non-illuminated models: A22K
Allowable operating frequency	Mechanical	Momentary operation: 60 operations/min max.		30 operations/min max.		Manual release: 30 operations/min max. Automatic release: 30 operations/min max.		
	Electrical	30 operations/min max.				30 operations/min max.		
Insulation resistance		100 MΩ min. (at 500 VDC)						
Dielectric strength		2,500 VAC, 50/60 Hz for 1 min between terminals of same polarity 2,500 VAC, 50/60 Hz for 1 min between terminals of different polarity and also between each terminal and ground						
Vibration resistance (See note 2)		Malfunction: 10 to 55 Hz, 1.5-mm double amplitude (malfunction within 1 ms)						
Shock resistance	Mechanical	1,000 m/s ² {100G}	1,000 m/s ² {100G}	1,000 m/s ² {100G}		1,000 m/s ² {100G}	1,000 m/s ² {100G}	1,000 m/s ² {100G}
	Malfunction (See note 2)	1,000 m/s ² {100G} max.	600 m/s ² {60G} max.	250 m/s ² {25G} max.		1,000 m/s ² {100G} max.	600 m/s ² {60G} max.	1,000 m/s ² {100G} max.
Life expectancy	Mechanical	Momentary operation: 5,000,000 operations min.		Momentary operation: 300,000 operations min.		500,000 operations min.	100,000 operations min.	500,000 operations min.
	Electrical	500,000 operations min.		300,000 operations min.	300,000 operations min.	500,000 operations min.	100,000 operations min.	500,000 operations min.
Ambient temperature (See note 1)		Operating: -20°C to 70°C (-4°F to 158°F) Storage: -40°C to 70°C (-40°F to 158°F)	Operating: -20°C to 55°C (-4°F to 131°F) Storage: -40°C to 70°C (-40°F to 158°F)	Operating: -20°C to 70°C (-4°F to 158°F) Storage: -40°C to 70°C (-40°F to 158°F)	Operating: -20°C to 55°C (-4°F to 131°F) Storage: -40°C to 70°C (-40°F to 158°F)	Operating: -20°C to 70°C (-4°F to 158°F) Storage: -40°C to 70°C (-40°F to 158°F)	Operating: -20°C to 55°C (-4°F to 131°F) Storage: -40°C to 70°C (-40°F to 158°F)	Operating: -20°C to 70°C (-4°F to 158°F) Storage: -40°C to 70°C (-40°F to 158°F)
Ambient humidity		Operating: 35% to 85%						
Degree of protection		IP65						
Electric shock protection class		Class II						
Degree of contamination		3 (IEC947-5-1)						



Note: 1. With no icing or condensation.
2. Malfunction within 1 ms.

■ OPERATING CHARACTERISTICS (FOR SPST-NO/SPST-NC)

Item	Pushbutton switches	Emergency stop switches	Knob-type selector switch		Key-type selector switch	
	Illuminated Non-illuminated Pushbutton Switches	Push-lock turn-reset system	Manual release	Automatic release	Manual release	Automatic release
	A22-F, A22-G, A22-C, A22-S, A22-T, A22-H, A22-D, A22-M, A22L-T, A22L-H, A22L-D, A22L-G, A22L-C	A22E	A22S, A22W	A22S, A22W	A22K	
Total travel force (TTF) max.	29.4 N {3.0 kgf}	44.1 N {4.5 kgf}	0.34 N • m {3.5 kgf • cm} (See note)	0.25 N • m {2.5 kgf • cm} for two position (See note) 0.34 N • m {3.5 kgf • cm} for three position	0.34 N {3.5 gf} (See note)	0.25 N • m {2.5 kgf • cm} for three position (See note) 0.34 N • m {3.5 kgf • cm} for three position
Total travel (TT)	5.5 mm max.	10±1 mm	Approx. 90° for two position (Approx. 45° for three position)		Approx. 90° for two position	
Releasing force (RF) min.	—	0.25 N • m max. {2.5 kgf • cm} (See note)	0.34 N • m max. {3.5 kgf • cm} (See note)	—	0.34 N • m max. {3.5 kgf • cm} (See note)	—









Note: Rotation torque for Emergency Stop Pushbutton, Knob-type Selector, and Key-type Selector Switches.

Accessories (Order Separately)

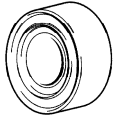
Item	Appearance	Classification	Remarks	Part number	
Contact Blocks		SPST-NO	General-pur- pose load	Provided as standard. Order Contact Blocks only when adding or replacing them.	A22-10
			Microload		A22-10S
		SPST-NC	General-pur- pose load		A22-01
			Microload		A22-01S
		DPST-NO	General-pur- pose load		A22-20
			Microload		A22-20S
		DPST-NC	General-pur- pose load		A22-02
			Microload		A22-02S
Lamp Sockets		Direct lighting	Used when changing the light- ing method.	A22-TN	
		Transformer illumination		110 VAC	A22-T1
				220 VAC	A22-T2
Mounting Latches		For momentary models	Provided as standard. Order Mounting Latches only when mounting Contact Blocks or Lamp Sockets that are purchased individually.	A22-3200	
Legend plate frames	Standard size	With Snap-in Legend Plate (Without text)	White	A22Z-3321	
			Red	A22Z-3322	
			Black	A22Z-3323	
			Without Snap-in Legend Plate	A22Z-3320	
	Large size	With Snap-in Legend Plate (Without text)	White	A22Z-3331	
			Red	A22Z-3332	
			Black	A22Z-3333	
			Without Snap-in Legend Plate	A22Z-3330	

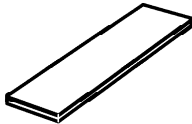
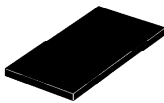

(This table continues on the next page.)

(continued from previous page)

Item	Appearance	Classification	Remarks	Part number	
Lock fitting		Round	The body is equipped with a Lock Fitting. This Lock Fitting is used when a more secure lock feature is required.	A22Z-3360	
Metallic bezel rings		For flush or projection models	Replace with the standard model. Material: nickel-plated zinc	A22Z-3580	
		For full-guard models		A22Z-3582	
Sealing caps		For flush models	Used to prevent dust or water from entering the Operational Unit. Color: opaque Material: silicon	A22Z-3600F	
		For extended models		A22Z-3600T	
		For full-guard models		A22Z-3600G	
Color lenses		Red	Used for changing the Operational Unit color of the Pushbutton Switch.	A22Z-30TR	
		Green		A22Z-30TG	
		Yellow		A22Z-30TY	
		White		A22Z-30TW	
		Blue		A22Z-30TA	
Three-throw spacers		For Pushbutton Switches	Used when mounting three Non-Illuminated Switch Units. Cannot be used with Illuminated Emergency Stop Switches.	A22Z-3003	
Hole plug		Round	Can be plugged into pre-cut panel holes for future expansion. The color is black.	A22Z-3550	
25 mm-dia. ring		25 mm ring	Can be fit into a 25 mm-dia. hole in the panel. Since this is not attached to the main body, order separately.	A22Z-R25	
Snap-in legend plates		Without text	Black	Attached to the Standard-size Legend Plate Frame. Material: Acrylic	A22Z-3443B
			Red		A22Z-3443R
			White		A22Z-3443W
		White text on red background	Transparent		A22Z-3443C
			○		A22Z-3443R-2
			STOP		A22Z-3443R-4
		White text on black background			A22Z-3443B-1
			START		A22Z-3443B-3
			ON		A22Z-3443B-5
			OFF		A22Z-3443B-6
			UP		A22Z-3443B-7
			DOWN		A22Z-3443B-8
			POWER ON		A22Z-3443B-9
			OFF-ON		A22Z-3443B-10
			Large size		
Red	A22Z-3453R				
White	A22Z-3453W				
Transparent	A22Z-3453C				
For Emergency Stop Switch		60-dia. round plate with black letters on a yellow background	"EMERGENCY STOP" is engraved on the plate. Used as an Emergency Stop Switch Legend Plate.	A22Z-3466-1	
		90-dia. round plate with black letters on a yellow background		A22Z-3476-1	

(This table continues on the next page.)

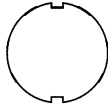
(continued from previous page)

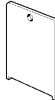
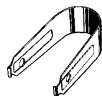
Item	Appearance	Classification	Remarks	Part number	
Character films		No print (Round)	After printing on a film, affix to the indicator plate of the Illuminated Pushbutton Switch. (The back is coated with adhesive.)	A22Z-3460	
		Character print (Round)			A22Z-3460-1
				○	A22Z-3460-2
				START	A22Z-3460-3
		STOP		A22Z-3460-4	
No print (Square)	A22Z-3480				
Lamp extractor		—	Rubber tool used to easily replace Lamps.	A22Z-3901	
Tightening wrench		—	Tool used to tighten nuts from the back of the panel.	A22Z-3905	
Lens tightening tool		—	Used for replacing the cap of the Half-guard Pushbutton Switch.	A22Z-3908	
Lens puller		—	Used for removing the lens from the indicator of the Square Illuminated Pushbutton Switch.	A3PJ-5080	

■ ENCLOSURES

Material	Hole size	Number of holes	Part number
Polyester	22.5 mm (0.88 in)	1	A22N-PENC-1
		2	A22N-PENC-2
		3	A22N-PENC-3
Metallic	22.5 mm (0.88 in)	1	A22N-MENC-1
		2	A22N-MENC-2
		3	A22N-MENC-3
		4	A22N-MENC-4
		6	A22N-MENC-6
		9	A22N-MENC-9
		12	A22N-MENC-12
16	A22N-MENC-16		

Note: For more information on pushbutton enclosures refer to drawings in the *Dimensions* section.

■ NAMEPLATE NOMENCLATURE

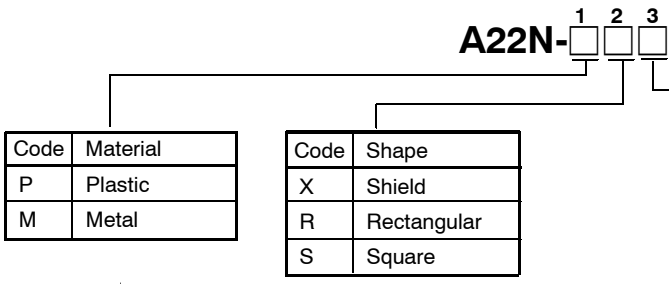

Note: To complete the part number of the standard nameplates, select the plate type and add the number from the table below.
Example: Plastic Square Nameplate engraved "Reset" A22N-PS38

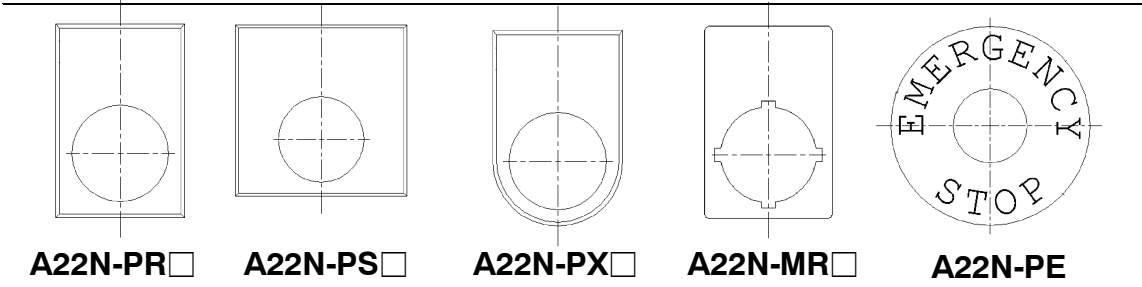

1	AUTO	30	ON	106	HIGH-LOW	150	AUTO-MAN-OFF	175	START-JOG-STOP
2	CLOSE	31	OPEN	107	INCH-REVERSE	151	AUTO-OFF-HAND	176	START-RUN-STOP
3	CYCLE START	32	OUT	108	JOG-FOR	152	AUTO-OFF-MAN	177	UP-OFF-DOWN
4	CYCLE STOP	33	POWER ON	109	JOG-REV	153	CLOSE-OFF-OPEN	178	1-OFF-2
5	DECREASE	34	PULL TO START	110	JOG-RUN	154	DOWN-OFF-SLOW	179	HAND-OFF-AUTO
6	DOWN	35	PUSH TO TEST	111	LEFT-RUN	155	FAST-OFF-SLOW	180	
7	EMERG.STOP (red)	36	PUSH TO STOP	112	LOWER-RAISE	156	FOR-OFF-REV	181	
8	FAST	37	RAISE	113	MAN-AUTO	157	FOR-STOP-REV	182	
9	FAULT	38	RESET	114	OFF-ON	158	HIGH-LOW-OFF	183	
10	FEED	39	REVERSE	115	ON-OFF	159	HIGH-OFF-LOW	184	
11	FEED START	40	RIGHT	116	OPEN-CLOSE	160	JOG-SAFE-RUN	185	
12	FEED STOP	41	RUN	117	RAISE-LOWER	161	JOG-STOP-RUN	186	
13	FLUID LEVEL LOW	42	SLOW	118	REV-FOR	162	LEFT-OFF-RIGHT	187	I-II-III
14	FORWARD	43	SPEED	119	RUN-INCH	163	LOC-OFF-REMOTE	188	III
15	FULL SPEED	44	START	120	RUN-JOG	164	LOW-OFF-HIGH	190	60 MM E-STOP
16	HAND	45	STOP	121	RUN-SAFE	165	LOWER-OFF-RAISE	191	90 MM E-STOP
17	HIGH	46	TEST	122	SAFE-RUN	166	OFF COOLANT ON	200	BLANK NAMEPLATE
18	IN	47	UP	123	SLOW-FAST	167	OFF-LOC-REMOTE	200E	SPECIAL ENGRAVING
19	INCH	48	1ST SPEED	124	START-JOG	168	OFF-MAN-AUTO		
20	INCREASE	49	2ND SPEED	125	START-STOP	169	OFF-SLOW-FAST		
21	JOG	50	3RD SPEED	126	STOP-START	170	OFF-1-2		
22	JOG FORWARD	51	4TH SPEED	127	SUMMER-WINTER	171	OPEN-OFF-CLOSE		
23	LEFT	100	AUTO-MAN	128	UP-DOWN	172	RAISE-OFF-LOWER		
24	LOW	101	CLOSE-OPEN			173	SLOW-OFF-FAST		
25	LOW SPEED	102	DOWN-UP			174	SLOW-OFF-START		
26	LOWER	103	FAST-SLOW						
27	MOTOR RUN	104	FOR-REV						
28	MOTOR STOP	105	HAND-AUTO						
29	OFF								

Note: All plastic name plates are adhesive backed, contain beveled edges and are supplied standard with white lettering on black background. Any deviation from items listed here will be a special order. Contact Omron.

Dimensions

Unit: mm (inch)

LEGEND PLATE FRAMES

A22Z-332

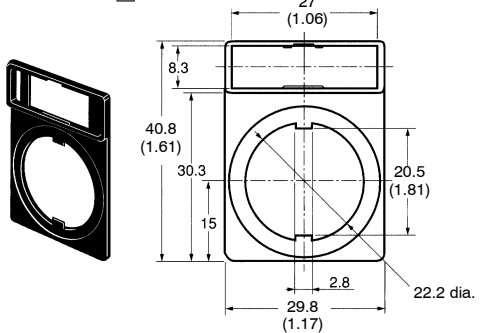

A22Z-333

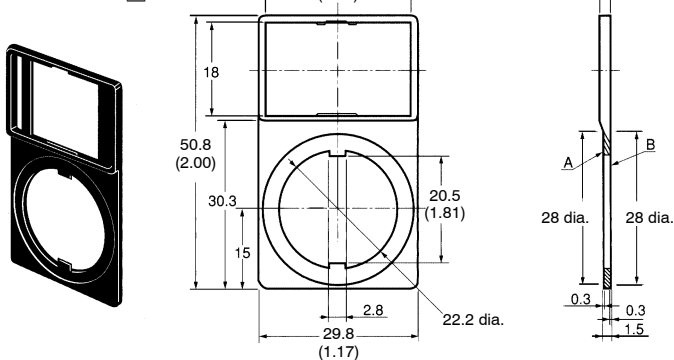

PLASTIC RECTANGULAR AND SHIELD

A22N-PR

A22N-PX

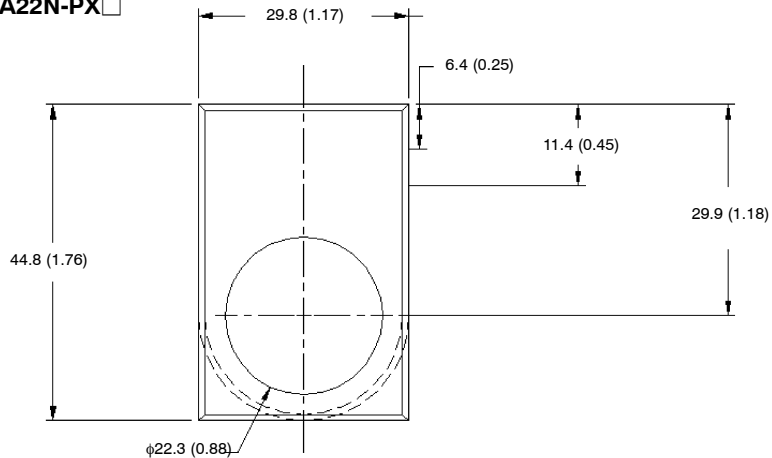

Note: Curved dashed line denotes difference between Rectangular and Rectangular to Round name plates.

PLASTIC SQUARE

A22N-PS

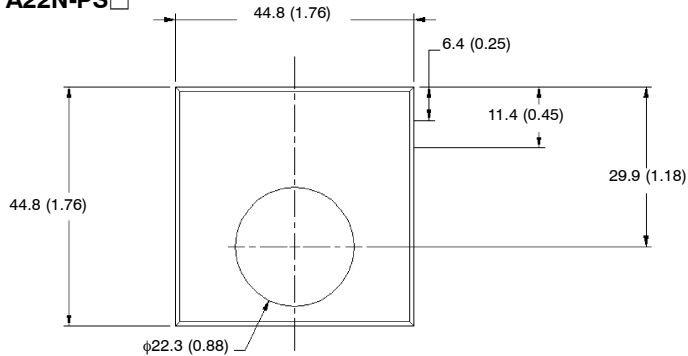

■ METAL RECTANGULAR

A22N-MR□

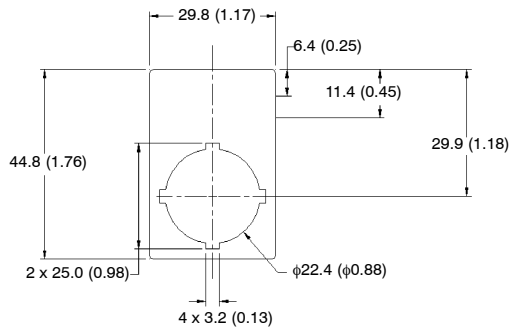

■ 60MM EMERGENCY STOP

A22PE190

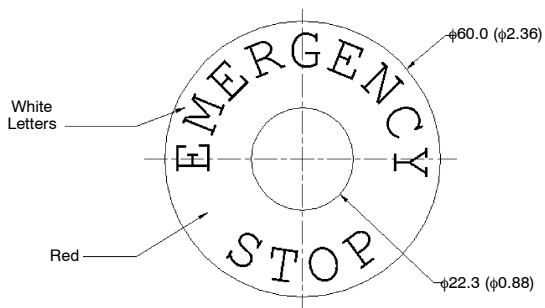

■ 90MM EMERGENCY STOP

A22N-PE191

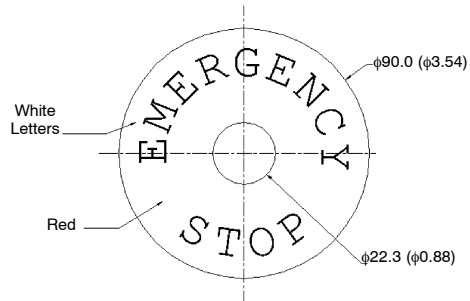

■ LOCK FITTING
A22Z-3360

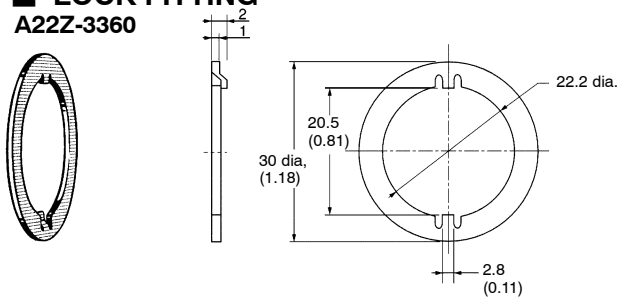

■ 25 MM-DIA. RING
A22Z-R25

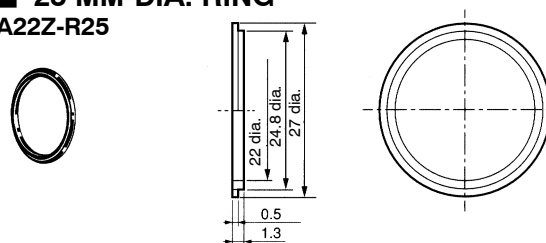

■ COLOR LENS
A22L-30T□

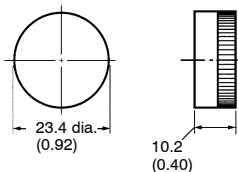
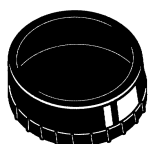

■ HOLE PLUG (ROUND)
A22Z-3530

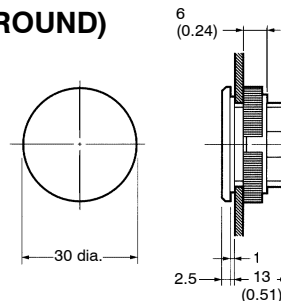

■ SEALING CAPS

For Flush Models
A22Z-3600F

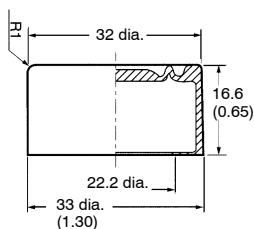
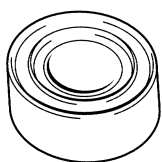

For Extended Head Models
A22Z-3600T

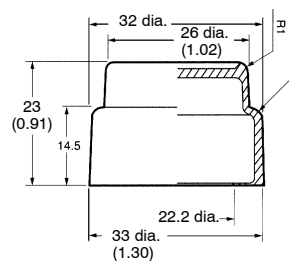
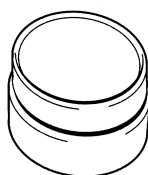

For Full-guard Models
A22Z-3600G

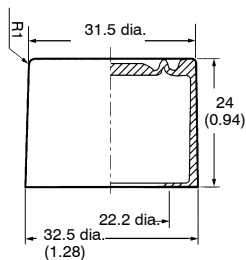

■ **THREE-THROW SPACER**

A22Z-3003

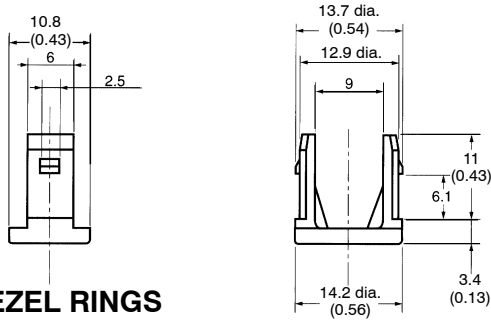
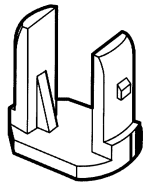

■ **METALLIC BEZEL RINGS**

For Flush/Extended Models
A22Z-3580

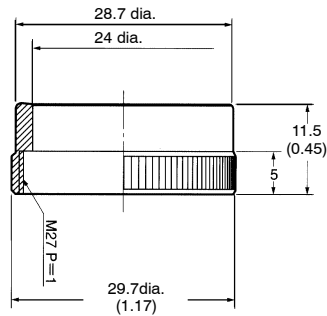
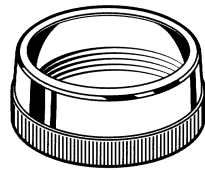

For Full-guard Models
A22Z-3582

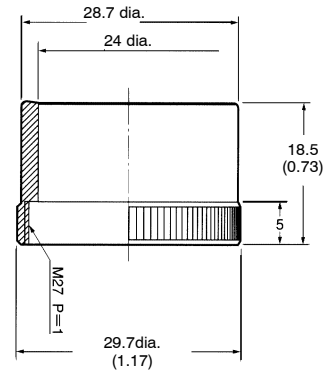
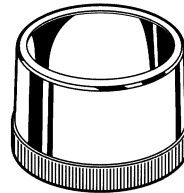

■ **SNAP-IN LEGEND PLATES**

For General-purpose Models
A22L-3443 □-□

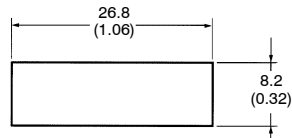
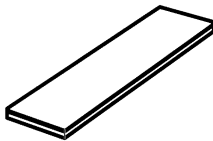

For Large Models
A22Z-3453 □

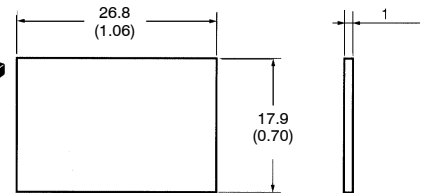
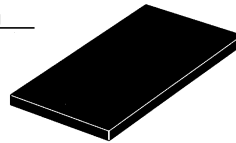

■ **CHARACTER FILM**

For Round Models
A22Z-3460-□

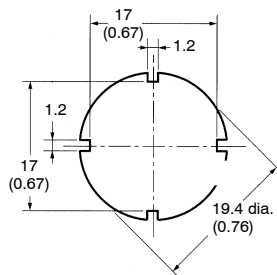
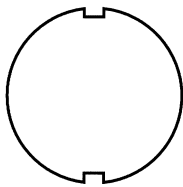

For Square Models
A22Z-3480

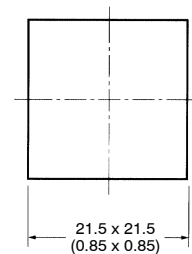
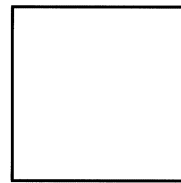

Unit: mm (inch)

■ LAMP EXTRACTOR

A22Z-3901

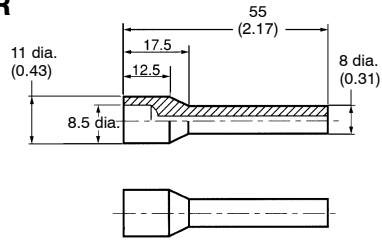

■ TIGHTENING WRENCH

A22Z-3905

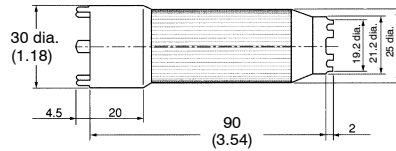
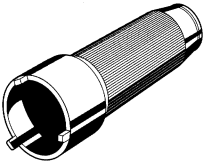

■ LENS TIGHTENING TOOL

A22Z-3908

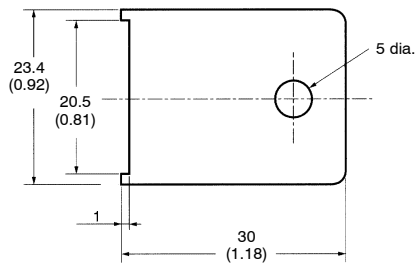
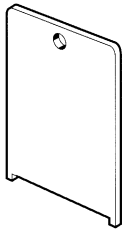

■ LENS PULLER

A3PJ-5080

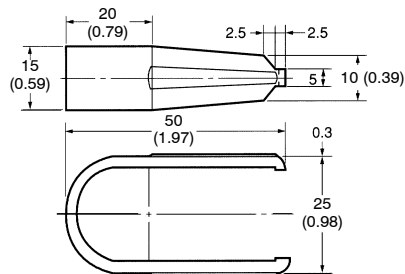
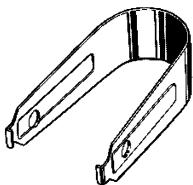

■ ENCLOSURES (POLYESTER)

A22N-PENC-□

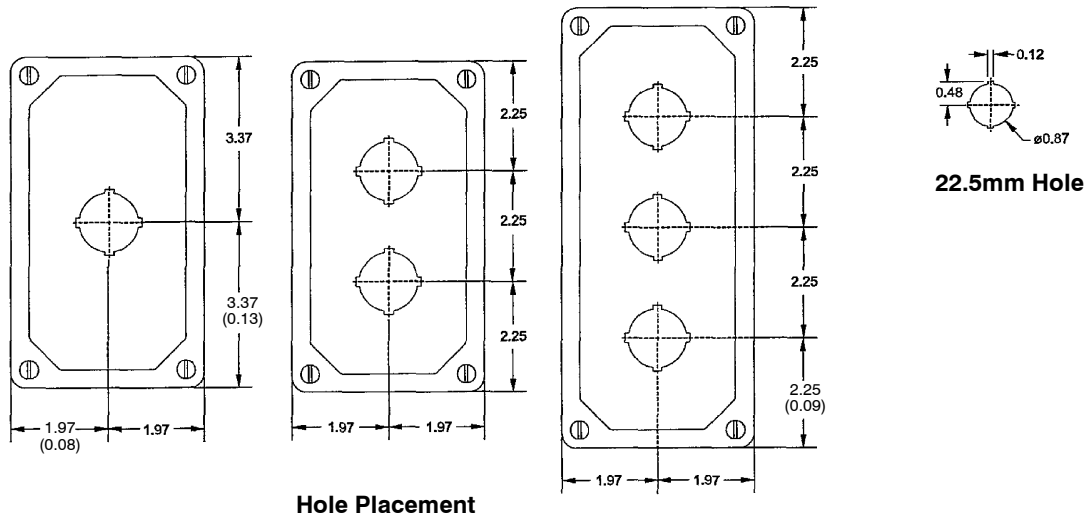
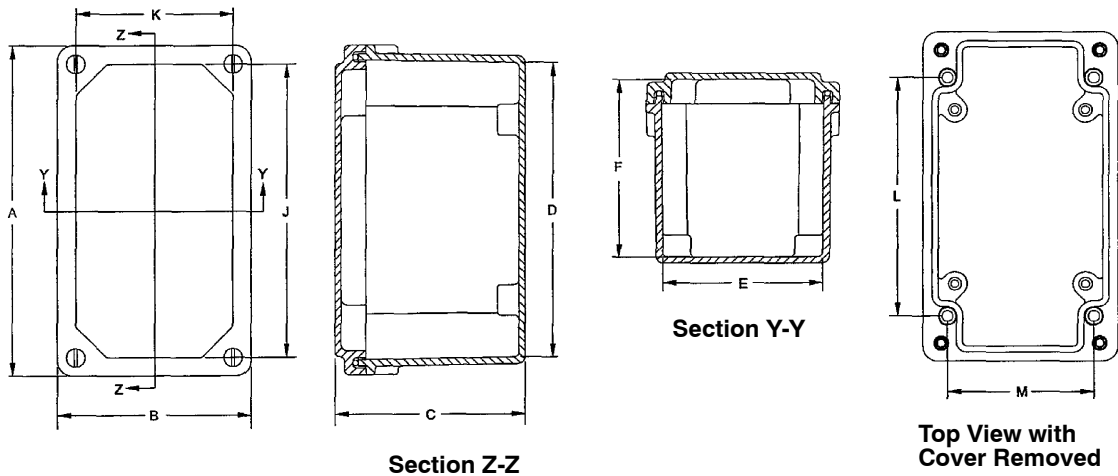

Part No.	Overall Dimensions			Inside Dimensions				L	M	No. of Holes	Hole Size	
	A	B	C	D	E	F	J					K
A22N-PENC-1	6.74	3.93	3.88	6.01	3.26	3.63	5.99	3.18	4.88	2.94	1	22.5
A22N-PENC-2	6.74	3.93	3.88	6.01	3.26	3.63	5.99	3.18	4.88	2.94	2	22.5
A22N-PENC-3	8.99	3.93	3.88	8.26	3.26	3.63	8.24	3.18	7.13	2.94	3	22.5

■ ENCLOSURES (METALLIC)

A22N-MENC-□

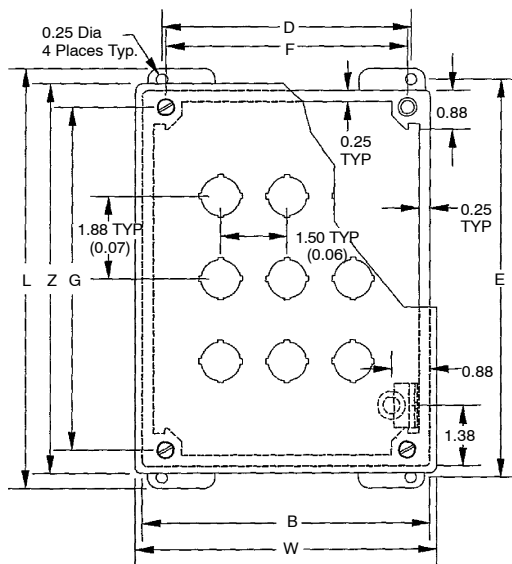

Body Type MENC-6 through MENC-16 (hinged)

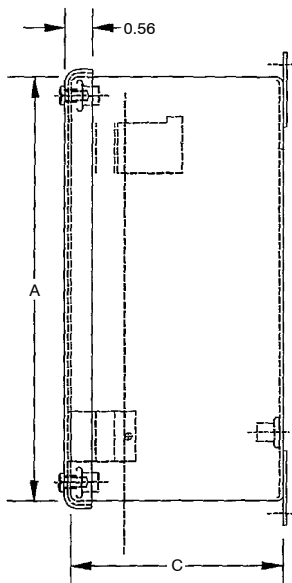

Side View

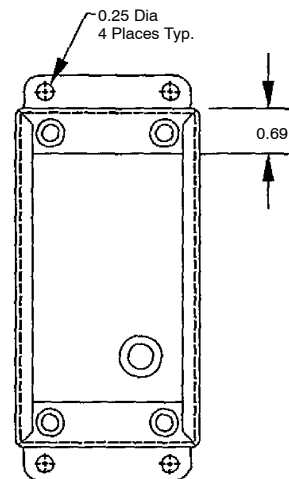

Body Type MENC-1 MENC-2, MENC-3 and MENC-4 (not hinged)

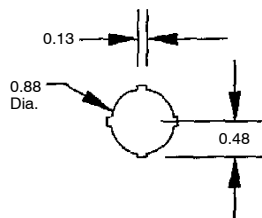

Typical Pushbutton Detail

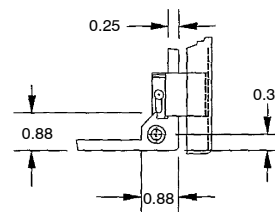

Hinge Detail

Retractable pin allows door to be mounted on left or right side

Part No.	No. of Holes	Overall Dimensions									Ship Wt. lbs.	
		A	B	C	D	E	F	G	L	W		Z
A22N-MENC-1	1	3.25	2.75	3.50	1.88	3.75	1.71	2.50	4.25	3.06	3.56	2
A22N-MENC-2	2	5.13	2.75	3.50	1.88	5.63	1.71	4.38	6.13	3.06	5.44	3
A22N-MENC-3	3	7.00	2.75	3.50	1.88	7.50	1.71	6.25	8.00	3.06	7.31	3
A22N-MENC-4	4	8.88	2.75	3.50	1.88	9.38	1.71	8.13	9.88	3.06	9.19	4
A22N-MENC-6	6	8.50	5.00	4.25	4.13	9.00	3.96	7.75	9.50	5.31	8.81	5
A22N-MENC-9	9	8.50	6.50	4.25	5.63	9.00	5.46	7.75	9.50	6.81	8.81	6
A22N-MENC-12	12	10.38	6.50	4.25	5.63	10.88	5.46	9.36	11.38	6.81	10.69	6
A22N-MENC-16	16	10.38	8.00	4.25	7.13	10.88	6.96	9.63	11.38	8.31	10.69	7

Installation

■ MOUNTING THE PANEL

Panel Hole Dimensions

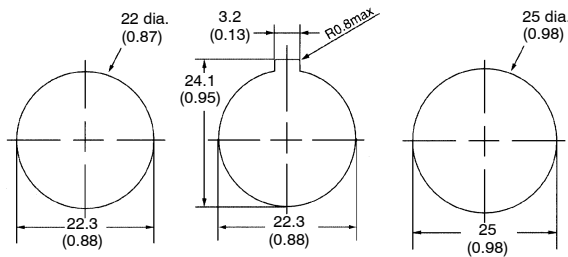

For 25 mm-dia. holes, always use 25 mm-dia. Rings. (Since the cutout dimensions are large, IP65 cannot be guaranteed unless 25-dia. Rings are used.)

If outer surface treatment such as paint is applied to the panel, the panel dimensions after outer surface treatment must meet the specified panel dimensions.

■ MATRIX INSTALLATION

- The following panel hole dimensions apply when Switch Units and the Standard-size Legend Plate Frame Lock Fitting are mounted.

A22Z

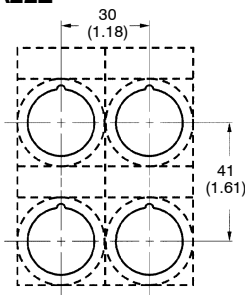

A22N-PR, -MR, -PX

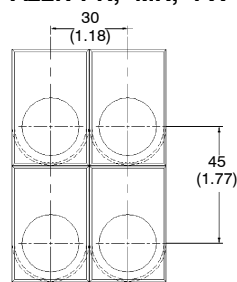

- The following panel hole dimensions apply when the Large-size Legend Plate Frame is mounted.

A22Z

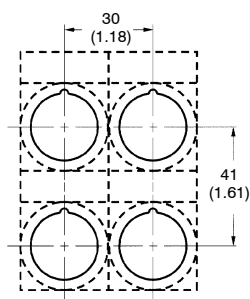

A22N-S

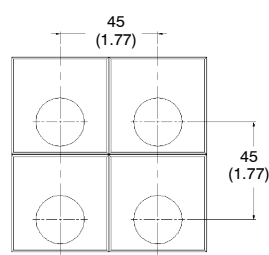

Locking should be applied toward the Engraving Plate.

Note: The above dimensions are the smallest-possible mounting dimensions. However, these dimensions do not apply to large Pushbutton Switches. For large Pushbutton Switches, determine the distance between holes, taking the Operational Unit and Legend Plate Frame into account.

■ MOUNTING THE OPERATIONAL UNIT ON THE PANEL

Insert the Operational Unit from the front surface of the panel, insert the Lock Fitting and the mounting nut from the terminal side, then tighten the nut. Before tightening, check that the rubber washer is present between the Operational Unit and the panel.

When using a Legend Plate Frame, put one rubber washer each between the Legend Plate Frame and the panel and between the Operational Unit and the Legend Plate Frame. (One rubber washer will be provided when one Legend Plate Frame is ordered.)

Align the Lock Fitting with the groove in the casing, then insert the Lock Fitting so that its edge is located on the panel side.

Tighten the mounting nut at a torque of 0.98 to 1.96 N • m {10 to 20 kgf • cm}.

When using a Lock Ring, replace with the supplied Lock Fitting, insert the projecting part into the lock slot, and then tighten the mounting nut.

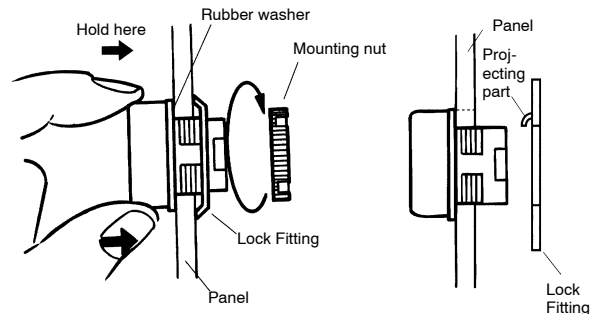

When the panel cutout dimension is 25 mm dia., remove the supplied rubber washer and mount the 25 mm-dia. Ring as shown below. (Since the A22Z-R25 is not attached to the main body, order separately.)

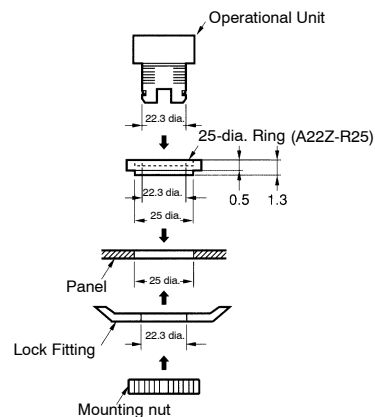

■ MOUNTING THE SWITCH ON THE OPERATIONAL UNIT

Insert the Operational Unit into the Switch Unit, aligning the arrow mark inscribed on the Operational Unit with the lever on the Switch Unit, then move the lever in the direction indicated by the arrow in the following figure.

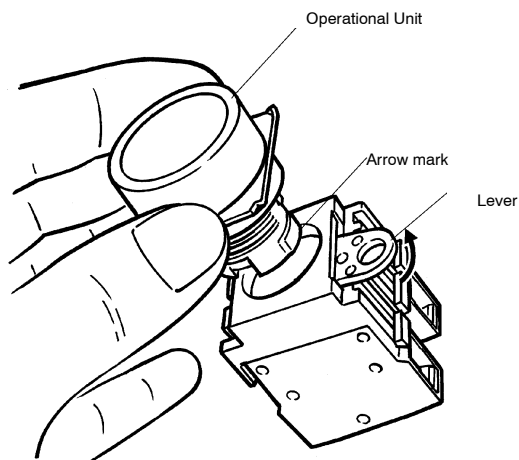

■ REMOVING THE SWITCH

Move the lever in the direction indicated by the arrow in the following figure, then pull the Operational Unit or the Switch Unit.

Since the lever has a hole with an inside diameter of 6.5 mm, the lever can be moved in the specified direction by inserting a screwdriver into the hole and then moving the screwdriver.

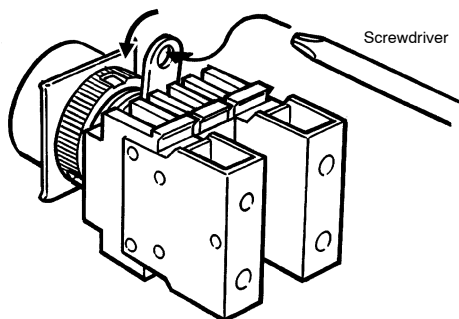

■ MOUNTING/REPLACING THE COLOR LENS

Projection, Full-guard

Grip and rotate the Color Lens with your fingers.

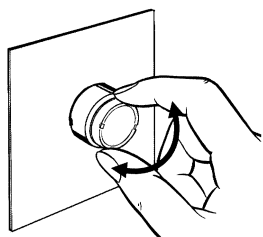

Half-guard Indicators

Put the tips of the Lens Tightening Tool (A22Z-3908) into the Color Lens slot and turn the Tool.

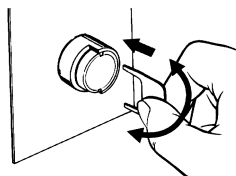

■ ASSEMBLING THE CAP

Lighted Pushbutton Switch

Mount the Color Lens so that the protrusions inside the cap fit into the grooves in the Operational Unit.

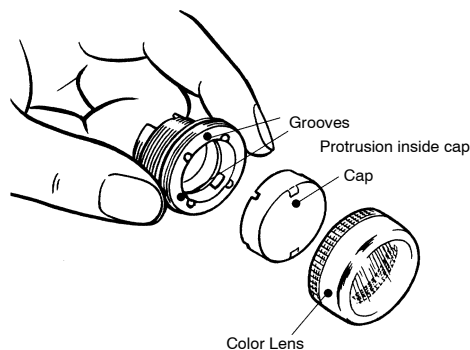

Indicator

Mount the Color Lens so that the protrusions inside the Operational Unit fit into the grooves in the cap.

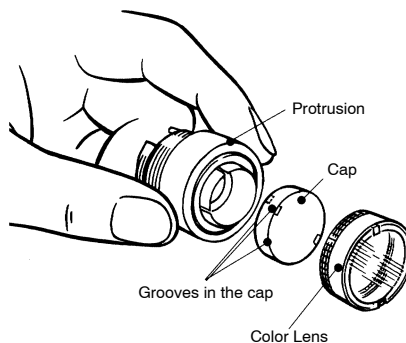

Square Pushbutton/Indicator

Removing the Color Lens:

Insert the protruding tip of the Lens Puller (A3PJ-5080) into the lens slot, hold the plate spring, and pull them to remove the Color Lens.

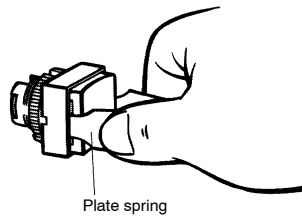

Mounting the Color Lens:

Mount the Color Lens on the flange and firmly push the Color Lens. When the Color Lens is inserted, check whether it operates properly. When replacing the Lamp, remove the Color Lens and diffusion plate with fingers or Lens Puller.

Attach the Character Film properly so that it fits inside the protruding part of the diffusion plate. Then, match the diffusion plate to the square flange and insert the Lens.

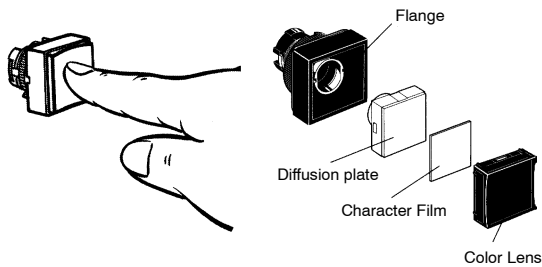

Installing/Replacing on the Switch Unit

Grip the indicator with your fingers, then rotate the indicator while pressing it against the Switch Unit.

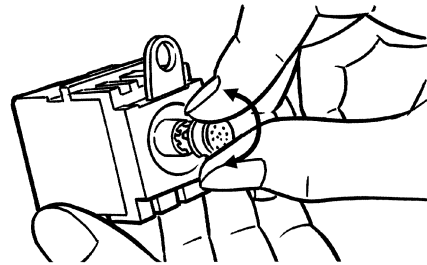

■ CONTROL BOX (ENCLOSURE)

Mounting the Switch

The Standard-size Legend Plate Frame can be mounted. Mount the Frame as shown in the following diagram. Mount the Switch in the same way as for an ordinary panel.

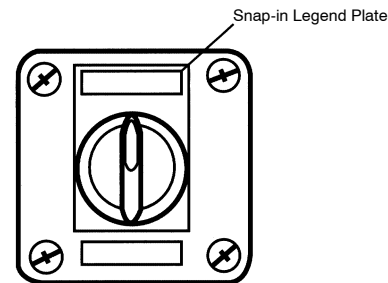

■ EMERGENCY STOP SWITCH

Insert the protrusion of the Tightening Wrench (A22Z-3905) into the Cap slot and then turn to remove the Cap.

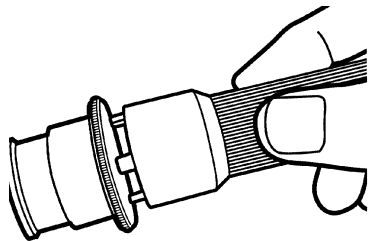

■ INSTALLING/REPLACING THE LAMP

Installing from the Panel Surface

Insert the Lamp Extractor (A22Z-3901) into the lamp, then rotate the Extractor while pressing it.

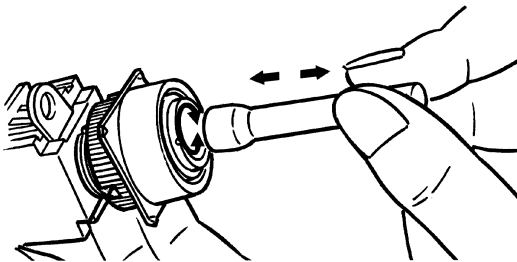

■ INSTALLING/REMOVING THE SWITCH UNIT

Installing the Switch Unit

Hook the small protrusion on the Switch Unit into the groove on the other side of the lever, then push up the Switch Unit in the direction indicated by the arrow in the figure below.

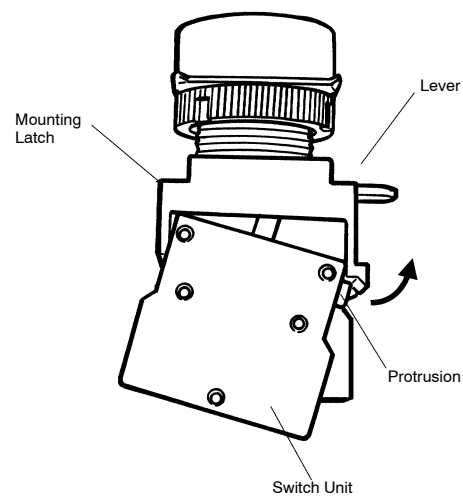

Removing the Switch Unit

Insert a screwdriver between the Mounting Latch and the Switch Unit, then push down the screwdriver in the direction indicated by the arrow in the following figure.

Use either of the following screwdrivers.

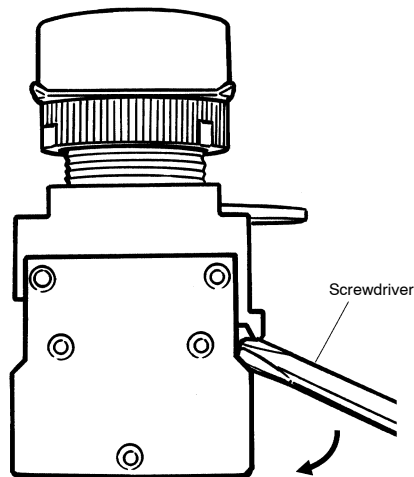
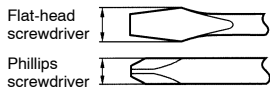

WIRING

Wiring Round Crimp Terminals

Loosen the terminal screw from the Switch Unit until it completely comes off the groove, insert a screwdriver as shown in the following figure, then push up the washer in the direction indicated by the arrow to temporarily secure it. Now, a round crimp terminal can be connected. After inserting the terminal, tighten the screws to complete wiring.

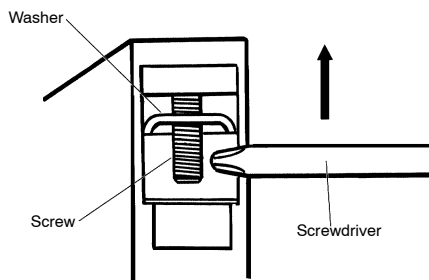

ENGRAVING

Engrave the characters on the surface on the Cap. Make sure that the characters are aligned parallel to the imaginary line connecting the two protruding portions to the left and right of the Cap.

The characters must not be engraved deeper than 0.5 mm. Apply an alcohol-based paint coating, such as melamine, alkyd, or acrylic resin paint coating, to the engraved characters.

Protruding portions on Cap

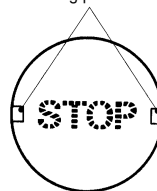

AFFIXING CHARACTER FILM

Hold the Cap, remove the cardboard on the Film, and attach the Film to the Cap. Make sure that the protruding portions of the Cap engage the cutout portions of the Film and that the characters are aligned parallel to the imaginary line connecting the two protruding portions to the left and right of the Cap.

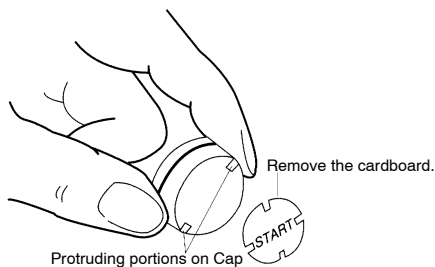

MOUNTING AND DISMOUNTING SNAP-IN LEGEND

Press and secure the Snap-in Legend Plate onto the Legend Plate Frame.

The direction of the characters will vary with the mounting direction of the control panel if the Switch is a knob or key selector model.

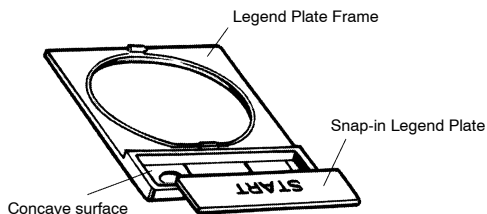

To easily remove the Snap-in Legend Plate from the Legend Plate Frame mounted to the panel, insert a Tool with a thin tip into the space between the Snap-in Legend Plate and the Legend Plate Frame.

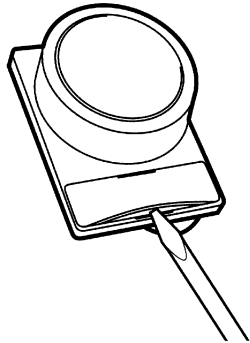

The Snap-in Legend Plate is easily removed by pressing the Snap-in Legend Plate from the back of the Legend Plate Frame.

The Legend Plate Frame is made of acrylic resin, which is easily damaged by shock. Be sure to handle the Legend Plate Frame with care.

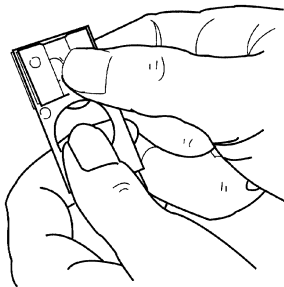

■ ENGRAVING METHOD

Material: Acrylic

Engrave the characters directly on the matted side of the Snap-in Legend Plate.

The characters must be engraved no deeper than 0.5 mm.

Apply alcohol-based paint coating to the engraved characters.

If the Snap-in Legend Plate is transparent, engrave the mirror-written characters on the back of the Snap-in Legend Plate and apply paint coating to the characters. Then apply paint coating of a different color to the remaining part of the Snap-in Legend Plate.

■ MOUNTING THREE-THROW SPACER

Press and secure the two protruding portions of the Three-throw Spacer to the two indented portions of the inner side of the control panel.

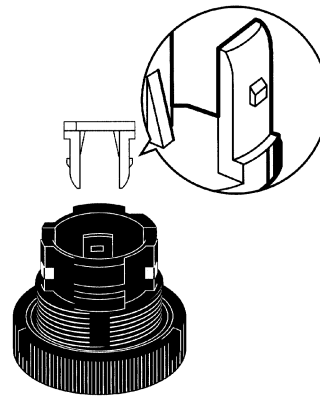

Precautions

⚠ WARNING

Do not apply a voltage between the incandescent lamp and the terminal that is greater than the rated voltage. If the incandescent lamp is broken, the Operational Units may pop out.

Always turn OFF the power and wait for 10 minutes before replacing the incandescent lamp. If the lamp is replaced immediately after the power is turned OFF, the remaining heat may cause burns.

■ CORRECT USE

Mounting

Always make sure that the power is turned OFF before mounting, removing, or wiring the Switch, or performing maintenance.

Do not tighten the mounting ring more than necessary using tools such as pointed-nose pliers. Doing so will damage the mounting ring. The tightening torque is 0.98 to 1.96 N • m {10 to 20 kgf • cm}.

The panel thickness is 1 to 5 mm.

Wiring

After wiring the Switch, maintain an appropriate clearance and creepage distance.

When DC-specific LEDs are used, wire the Switch so that the X1 terminal is positive.

Terminal screws must be Phillips or slotted M3.5 screws with a square washer.

The tightening torque is 1.08 to 1.27 N • m {11 to 13 kgf • cm}.

Single wires, stranded wires, and crimp terminals can be connected to the Switch.

Operating Environment

The IP65 model is designed with a protective structure so that it will not sustain damage if it is subjected to water from any direction to the front of the panel.

Using the Microload

Insert a contact protection circuit, if necessary, to prevent the reduction of life expectancy due to extreme wear on the contacts caused by loads where inrush current occurs when the contact is opened and closed.

The minimum applicable load is the N-level reference value. This value indicates the malfunction reference level for the reliability level of 60% ($\lambda . 60$) (conforming to JIS C5003).

The equation, $\lambda . 60 = 0.5 \times 10^{-4} / \text{time}$ indicates that the estimated malfunction rate is less than 1/2,000,000 with a reliability level of 60%.

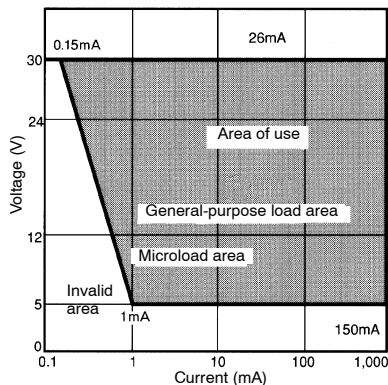

LEDs

The LED current-limiting resistor is built-in, so internal resistance is not required.

If commercially available LEDs are used, select the ones that meet the following conditions:

Base: BA9S/13□

Overall length: 26 mm max.

Power consumption: 2.6 W max.

Others

The oil-resistant IP65 uses NBR rubber and is resistant to general cutting oil and cooling oil. Some particular oils cannot be used with the oil-resistant IP65, however, so contact your OMRON representative for details.

If the panel is to be finished with coating, etc., make sure that the panel meets the specified dimensions after the coating.

Do not subject the Switch to extreme shock or vibration. Doing so will cause malfunctions and damage to the Switch.

Do not let sharp objects come into contact with the Switches that are made of resin. Doing so will damage the Switches, causing scratches on the outside of the Operational Units, and malfunction.

When handling the Switches, do not throw or drop them.

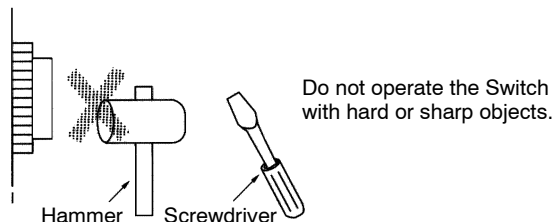
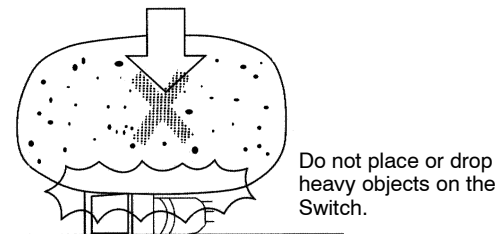
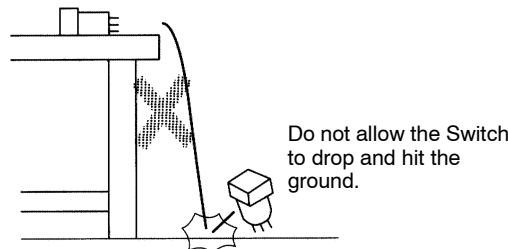

NOTE: DIMENSIONS SHOWN ARE IN MILLIMETERS. To convert millimeters to inches divide by 25.4.

OMRON[®]
OMRON ELECTRONICS LLC
 One East Commerce Drive
 Schaumburg, IL 60173
1-800-55-OMRON

OMRON ON-LINE
 Global - <http://www.omron.com>
 USA - <http://www.omron.com/oei>
 Canada - <http://www.omron.com/oci>

OMRON CANADA, INC.
 885 Milner Avenue
 Scarborough, Ontario M1B 5V8
416-286-6465