

**1-Line, Bi-directional, Ultra-low Capacitance
Transient Voltage Suppressors**
Descriptions

The ESD73251CZ is an ultra-low capacitance TVS (Transient Voltage Suppressor) designed to protect high speed data interfaces. It has been specifically designed to protect sensitive electronic components which are connected to data and transmission lines from over-stress caused by ESD (Electrostatic Discharge).

The ESD73251CZ incorporates one pair of ultra-low capacitance steering diodes plus a TVS diode.

The ESD73251CZ may be used to provide ESD protection up to $\pm 20\text{kV}$ (contact discharge) according to IEC61000-4-2, and withstand peak pulse current up to 5.5A (8/20 μs) according to IEC61000-4-5.

The ESD73251CZ is available in DWN0603-2L package. Standard products are Pb-free and Halogen-free.

Features

- Stand-off voltage: $\pm 24\text{V}$ Max.
- Transient protection for each line according to IEC61000-4-2 (ESD): $\pm 20\text{kV}$ (contact discharge)
IEC61000-4-5 (surge): 5.5A (8/20 μs)
- Ultra-low capacitance: $C_J = 0.50\text{pF}$ typ.
- Ultra-low leakage current: $I_R < 1\text{nA}$ typ.
- Low clamping voltage: $V_{CL} = 7.6\text{V}$ typ. @ $I_{PP} = 16\text{A}$ (TLP)
- Solid-state silicon technology

Applications

- NFC antenna protection
- Protection of high-speed data lines

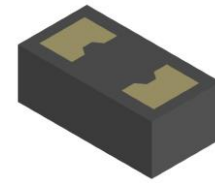
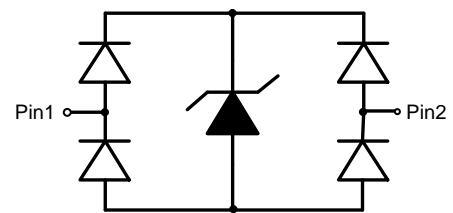
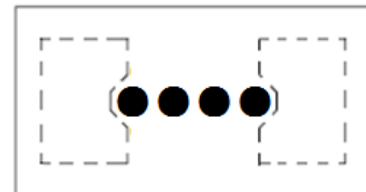
DWN0603-2L (Bottom View)

Pin configuration

●●●● = Device code

Marking (Top View)
Order information

| Device | Package | Shipping |
|-----------------|------------|-----------------|
| ESD73251CZ-2/TR | DWN0603-2L | 10000/Tape&Reel |

Absolute maximum ratings

| Parameter | Symbol | Rating | Unit |
|---|-----------|----------|-------------|
| Peak pulse power ($t_p = 8/20\mu s$) | P_{pk} | 36 | W |
| Peak pulse current ($t_p = 8/20\mu s$) | I_{PP} | 5.5 | A |
| ESD according to IEC61000-4-2 air discharge | V_{ESD} | ± 20 | kV |
| ESD according to IEC61000-4-2 contact discharge | | ± 20 | |
| Junction temperature | T_J | 125 | $^{\circ}C$ |
| Operating temperature | T_{OP} | -40~85 | $^{\circ}C$ |
| Lead temperature | T_L | 260 | $^{\circ}C$ |
| Storage temperature | T_{STG} | -55~150 | $^{\circ}C$ |

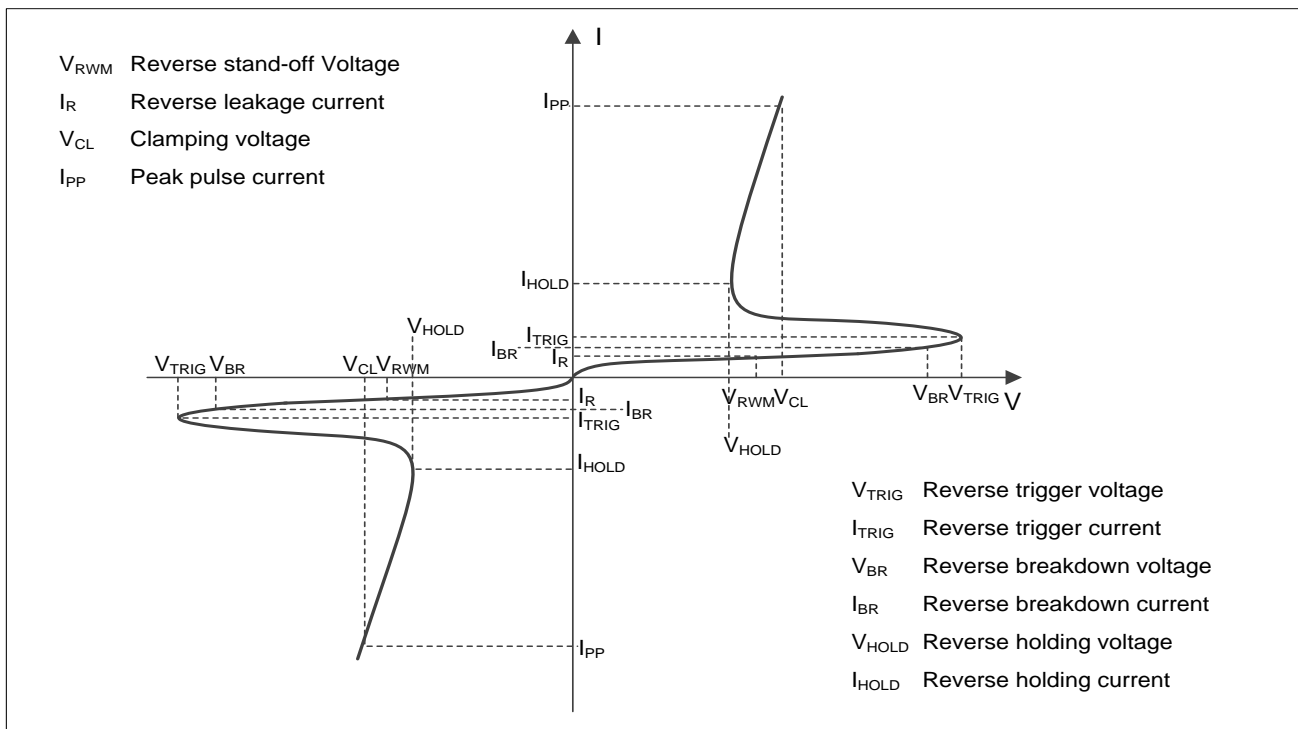
Electrical characteristics ($T_A=25^{\circ}C$, unless otherwise noted)

Definitions of electrical characteristics

Electrical characteristics (T_A=25 °C, unless otherwise noted)

| Parameter | Symbol | Condition | Min. | Typ. | Max. | Unit |
|----------------------------------|------------------|---|------|------|------|------|
| Reverse maximum working voltage | V _{RWM} | | | | ±24 | V |
| Reverse leakage current | I _R | V _{RWM} = 24V | | <1 | 100 | nA |
| Reverse breakdown voltage | V _{BR} | I _T = 1mA | 25.0 | | | V |
| Clamping voltage ¹⁾ | V _{CL} | I _{PP} = 16A, t _p = 100ns | | 7.6 | | V |
| Dynamic resistance ¹⁾ | R _{DYN} | | | 0.25 | | Ω |
| Clamping voltage ²⁾ | V _{CL} | V _{ESD} = 8kV | | 9 | | V |
| Clamping voltage ³⁾ | V _{CL} | I _{PP} = 1A, t _p = 8/20μs | | 3.6 | 4.5 | V |
| | | I _{PP} = 5.5A, t _p = 8/20μs | | 5.4 | 6.5 | V |
| Junction capacitance | C _J | V _R = 0V, f = 1MHz | | 0.50 | 0.70 | pF |

Notes:

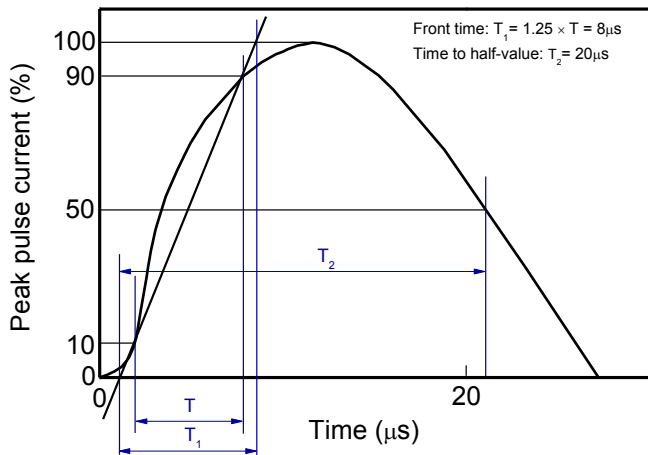
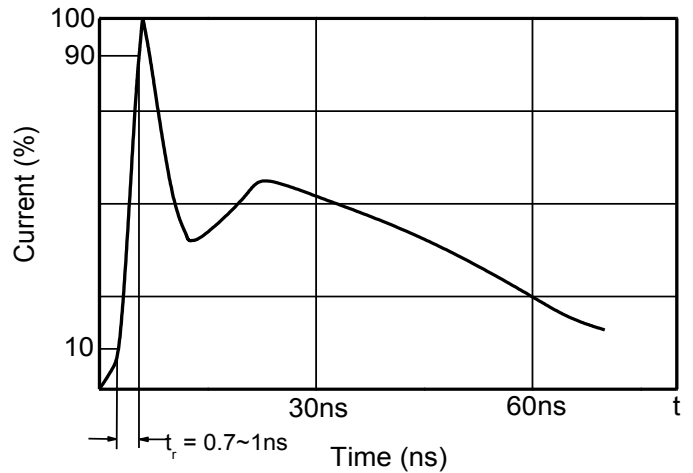
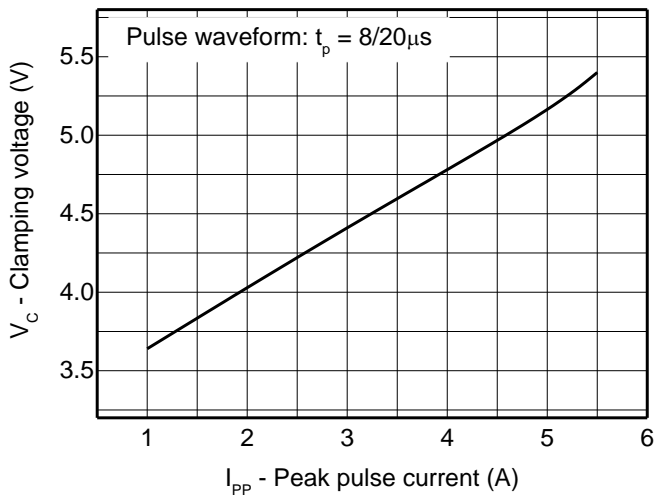
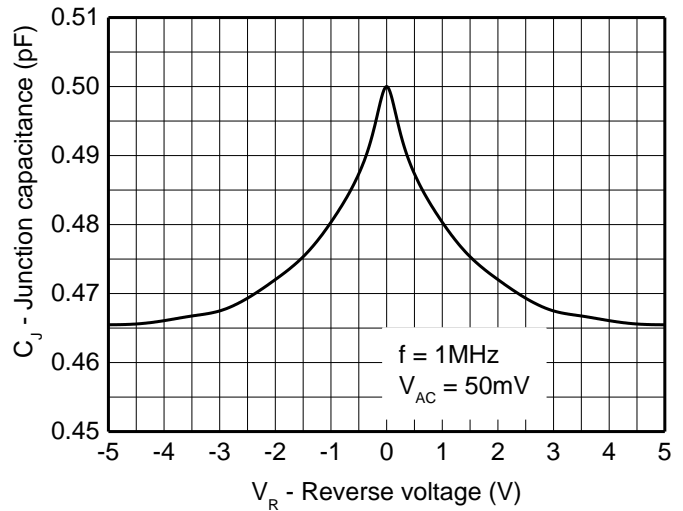
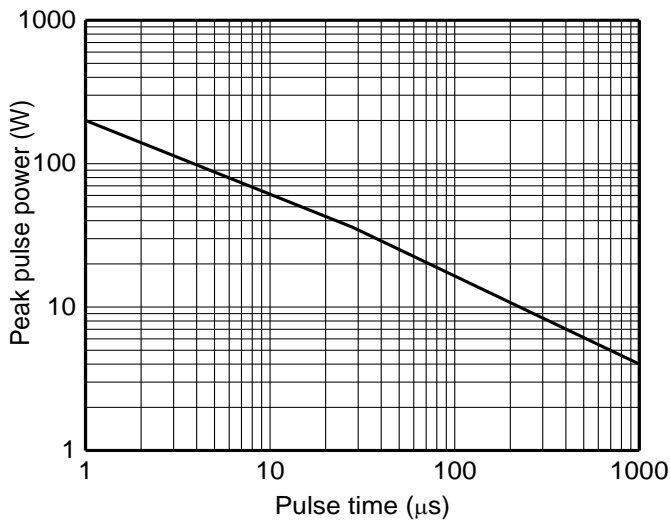
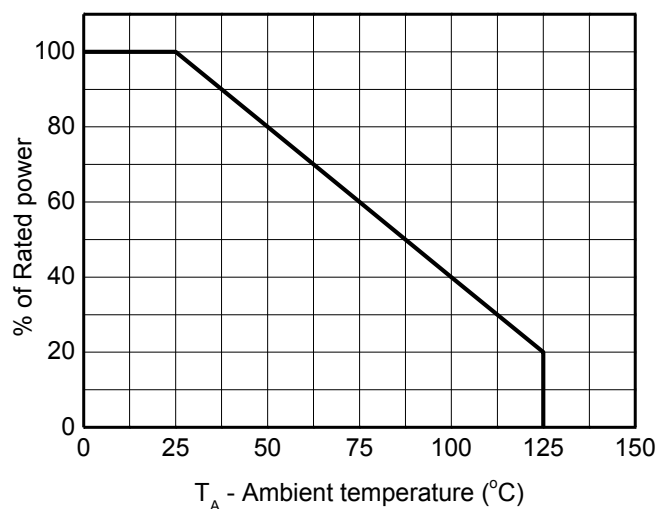
- 1) TLP parameter: Z₀ = 50Ω, t_p = 100ns, t_r = 2ns, averaging window from 60ns to 80ns. R_{DYN} is calculated from 4A to 16A.
- 2) Contact discharge mode, according to IEC61000-4-2.
- 3) Non-repetitive current pulse, according to IEC61000-4-5.

Typical characteristics ($T_A=25^\circ\text{C}$, unless otherwise noted)

8/20μs waveform per IEC61000-4-5

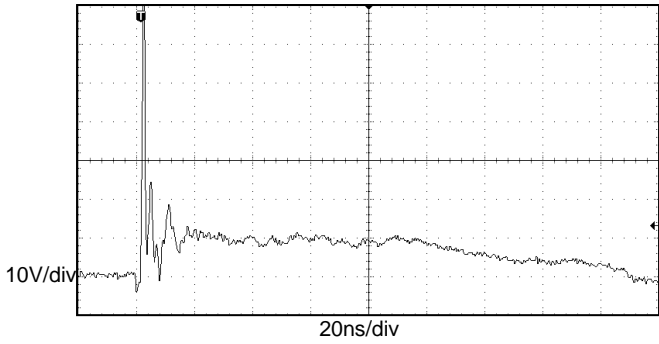
Contact discharge current waveform per IEC61000-4-2

Clamping voltage vs. Peak pulse current

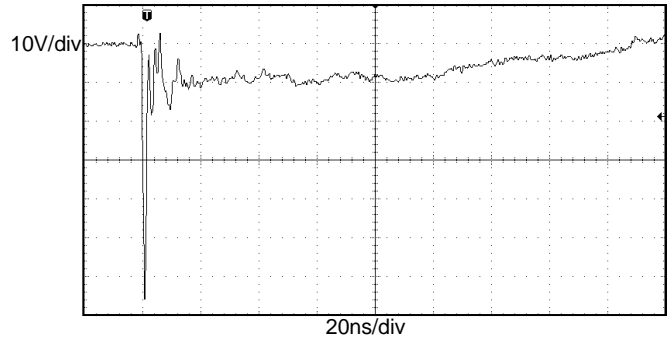
Capacitance vs. Reverse voltage

Non-repetitive peak pulse power vs. Pulse time

Power derating vs. Ambient temperature

Typical characteristics ($T_A = 25^\circ\text{C}$, unless otherwise noted)



ESD clamping
 (+8kV contact discharge per IEC61000-4-2)



ESD clamping
 (-8kV contact discharge per IEC61000-4-2)

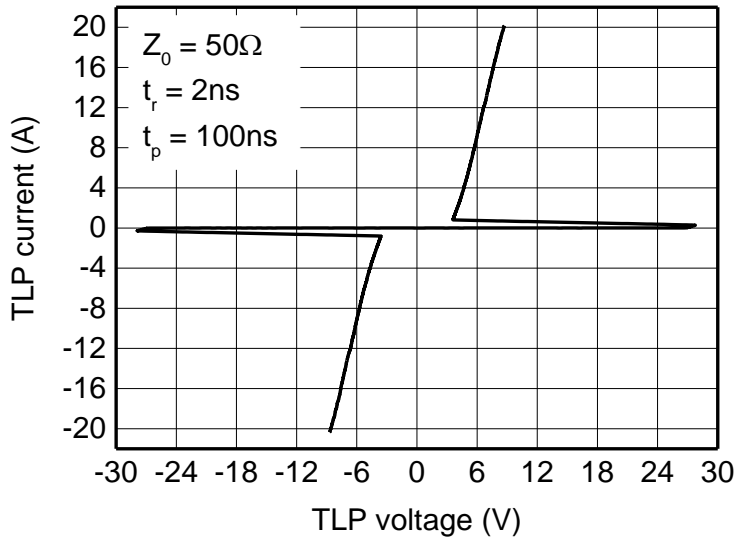

TLP Measurement

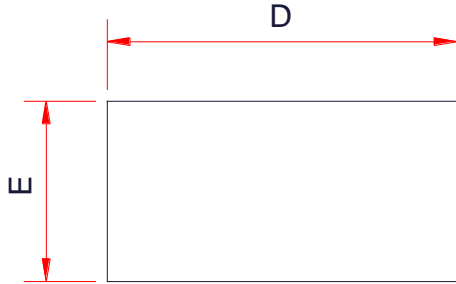
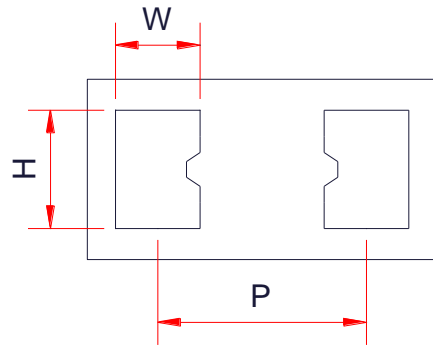
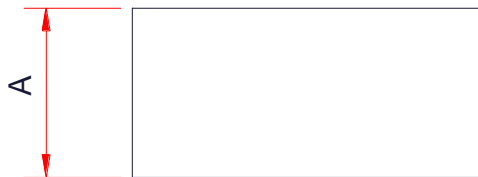
PACKAGE OUTLINE DIMENSIONS
DWN0603-2L

TOP VIEW

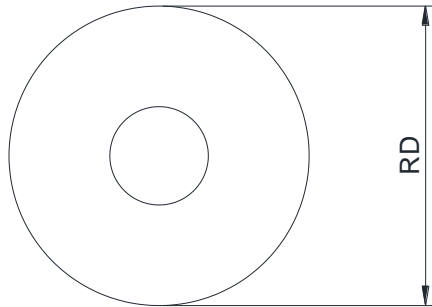
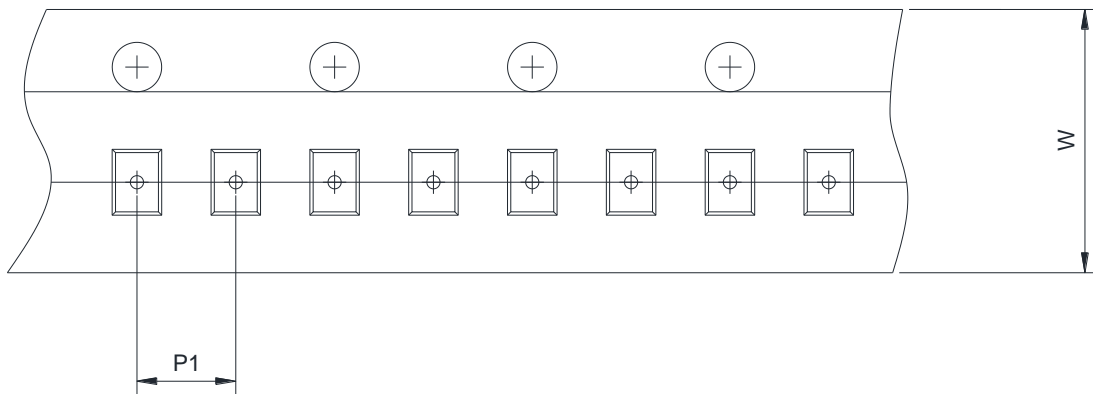
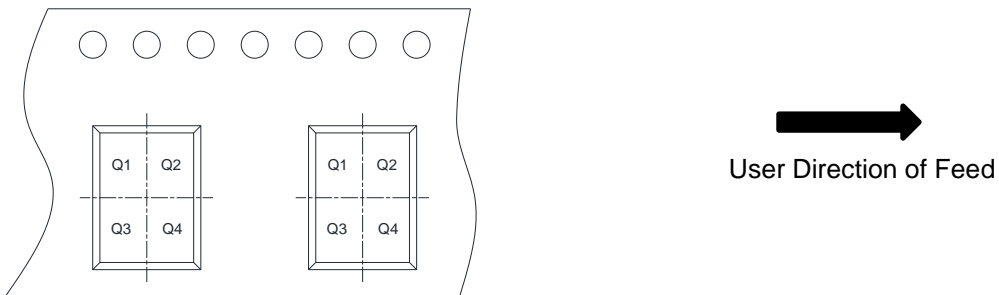
BOTTOM VIEW

SIDE VIEW

| Symbol | Dimensions in Millimeters | | |
|--------|---------------------------|------|------|
| | Min. | Typ. | Max. |
| A | 0.29 | 0.31 | 0.34 |
| E | 0.29 | 0.32 | 0.35 |
| D | 0.59 | 0.62 | 0.65 |
| W | 0.15Ref | | |
| H | 0.21Ref | | |
| P | 0.38Ref | | |

TAPE AND REEL INFORMATION
Reel Dimensions

Tape Dimensions

Quadrant Assignments For PIN1 Orientation In Tape

| | | |
|------|---|---|
| RD | Reel Dimension | <input checked="" type="checkbox"/> 7inch <input type="checkbox"/> 13inch |
| W | Overall width of the carrier tape | <input checked="" type="checkbox"/> 8mm <input type="checkbox"/> 12mm |
| P1 | Pitch between successive cavity centers | <input checked="" type="checkbox"/> 2mm <input type="checkbox"/> 4mm <input type="checkbox"/> 8mm |
| Pin1 | Pin1 Quadrant | <input type="checkbox"/> Q1 <input type="checkbox"/> Q2 <input type="checkbox"/> Q3 <input type="checkbox"/> Q4 |