

PREPARED BY: <i>M. Mitani</i> DATE: <i>Jan. 23, 1998</i>	SHARP	SPEC. No. ED-96197XB
APPROVED BY: <i>J. Yonikawa</i> DATE: <i>Jan 21 1998</i>		ISSUE January 23, 1998
		PAGE 10 Pages
		REPRESENTATIVE DIVISION OPTO-ELECTRONIC DEVICES DIV.
ELECTRONIC COMPONENTS GROUP SHARP CORPORATION		
SPECIFICATION		

DEVICE SPECIFICATION FOR	
PHOTOCOUPLER	Business dealing name
MODEL No.	
PC814	PC814X
	PC814X1

1. These specification sheets include materials protected under copyright of Sharp Corporation ("Sharp"). Please do not reproduce or cause anyone to reproduce them without Sharp's consent.
2. When using this product, please observe the absolute maximum ratings and the instructions for use outlined in these specification sheets, as well as the precautions mentioned below. Sharp assumes no responsibility for any damage resulting from use of the product which does not comply with the absolute maximum ratings and the instructions included in these specification sheets, and the precautions mentioned below.

(Precautions)

 - (1) This product is designed for use in the following application areas ;

• OA equipment	• Audio visual equipment	• Home appliances
• Telecommunication equipment (Terminal)	• Measuring equipment	
• Tooling machines	• Computers	

If the use of the product in the above application areas is for equipment listed in paragraphs (2) or (3), please be sure to observe the precautions given in those respective paragraphs.
 - (2) Appropriate measures, such as fail-safe design and redundant design considering the safety design of the overall system and equipment, should be taken to ensure reliability and safety when this product is used for equipment which demands high reliability and safety in function and precision, such as ;

• Transportation control and safety equipment (aircraft, train, automobile etc.)		
• Traffic signals	• Gas leakage sensor breakers	• Rescue and security equipment
• Other safety equipment		
 - (3) Please do not use this product for equipment which require extremely high reliability and safety in function and precision, such as ;

• Space equipment	• Telecommunication equipment (for trunk lines)
• Nuclear power control equipment	• Medical equipment
 - (4) Please contact and consult with a Sharp sales representative if there are any questions regarding interpretation of the above three paragraphs.
3. Please contact and consult with a Sharp sales representative for any questions about this product.

CUSTOMER'S APPROVAL

DATE _____
BY _____

DATE
PRESENTED
BY

J. M.

T. Matsumura,
Department General Manager of
Engineering Dept.,II
Opto-Electronic Devices Div.
ELECOM Group
SHARP CORPORATION

1. Application

This specification applies to the outline and characteristics of photocoupler Model No. PC814X.

2. Outline

Refer to the attached drawing No. CY8543K02.

3. Ratings and characteristics

Refer to the attached sheet, page 4 to 6.

4. Reliability

Refer to the attached sheet, page 7.

5. Outgoing inspection

Refer to the attached sheet, page 8.

6. Supplement

6.1 Isolation voltage shall be measured in the following method.

- (1) Short between anode and cathode on the primary side, and between collector and emitter on the secondary side.
- (2) The dielectric withstand tester with zero-cross circuit shall be used.
- (3) The wave form of applied voltage shall be a sine wave.
(It is recommended that the isolation voltage be measured in insulation oil.)

6.2 Collector current (Ic) Delivery rank table

("○" mark indicates business dealing name of ordered product)

Ordered product	Business dealing name	Rank mark	Ic (mA)
	PC814X	A or no mark	0.2 to 3.0
	PC814X1	A	0.5 to 1.5

Test conditions
$I_F = \pm 1 \text{ mA}$
$V_{CE} = 5 \text{ V}$
$T_a = 25^\circ \text{ C}$

6.3 This Model is approved by UL.

Approved Model No. : PC814X

UL file No. : E64380

6.4 This photocoupler is designed for AC input..

6.5 This product is not designed against irradiation.

This product is assembled with electrical input and output.

This product incorporates non-coherent light emitting diode.

6.6 ODS materials

This device · component shall not contain the following materials.
Also, the following materials shall not be used in the production process
for this device · component.

Materials for ODS : CFC_s, Halon, Carbon tetrachloride,
1.1.1-Trichloroethane (Methylchloroform)

6.7 Brominated flame retardants

Specific brominated flame retardants such as the PBBO_s and PBB_s are not used
in this device at all.

7. Notes

Refer to the attached sheet-1-1,2.

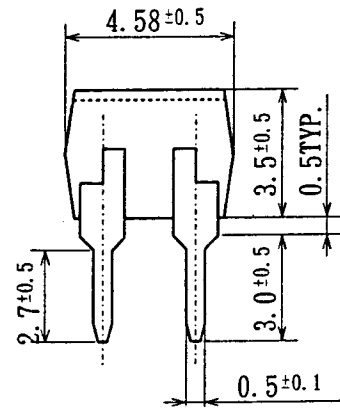
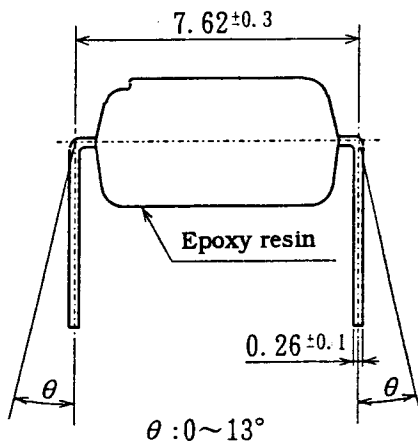
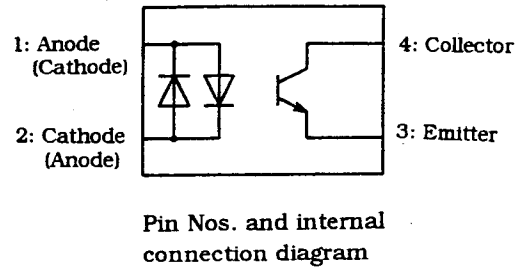
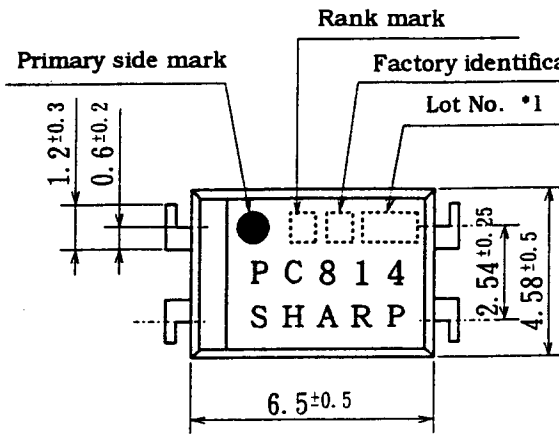

Product mass : Approx. 0.25g

- *1) 2-digit number shall be marked according to DIN standard.
- *2) Factory identification mark shall be or shall not be marked.

UNIT : 1/1 mm	
Name	PC814 Outline Dimensions (Business dealing name : PC814X)
Drawing No.	CY8543K02

3. Ratings and characteristics

3.1 Absolute maximum ratings

Ta=25°C

Parameter		Symbol	Rating	Unit
Input	*1 Forward current	I_F	± 50	mA
	*2 Peak forward current	I_{FM}	± 1	A
	*1 Power dissipation	P	70	mW
Output	Collector-emitter voltage	V_{CEO}	35	V
	Emitter-collector voltage	V_{ECO}	6	V
	Collector current	I_C	50	mA
	*1 Collector power dissipation	P_C	150	mW
*1 Total power dissipation		P_{tot}	200	mW
Operating temperature		T_{opr}	-30 to +100	°C
Storage temperature		T_{stg}	-55 to +125	°C
*3 Isolation voltage		V_{iso}	5	kVrms
*4 Soldering temperature		T_{sol}	260	°C

*1 The derating factors of absolute maximum ratings due to ambient temperature are shown in Fig. 1 to 4.

*2 Pulse width $\leq 100 \mu s$, Duty ratio : 0.001 (Refer to Fig. 5)

*3 AC for 1 min, 40 to 60%RH

*4 For 10 s

3.2 Electro-optical characteristics

Ta=25°C

Parameter		Symbol	Conditions	MIN.	TYP.	MAX.	Unit
Input	Forward voltage	V_F	$I_F = \pm 20\text{mA}$	-	1.2	1.4	V
	Peak forward voltage	V_{FM}	$I_{FM} = \pm 0.5\text{A}$	-	-	3.0	V
	Terminal capacitance	C_t	$V=0, f=1\text{kHz}$	-	50	250	pF
Output	Dark current	I_{CEO}	$V_{CE}=20\text{V}, I_F=0$	-	-	100	nA
	Collector-emitter breakdown voltage	BV_{CEO}	$I_C=0.1\text{mA}$ $I_F=0$	35	-	-	V
	Emitter-collector breakdown voltage	BV_{ECO}	$I_E=10\ \mu\text{A}, I_F=0$	6	-	-	V
Transfer characteristics	Collector current	I_C	$I_F = \pm 1\text{mA}$ $V_{CE}=5\text{V}$	0.2	-	3.0	mA
	Collector-emitter saturation voltage	$V_{CE(sat)}$	$I_F = \pm 20\text{mA}$ $I_C=1\text{mA}$	-	0.1	0.2	V
	Isolation resistance	R_{iso}	DC500V 40 to 60%RH	5×10^{10}	10^{11}	-	Ω
	Floating capacitance	C_f	$V=0, f=1\text{MHz}$	-	0.6	1.0	pF
	Cut-off frequency	f_c	$V_{CE}=5\text{V}, I_C=2\text{mA}$ $R_L=100\ \Omega, -3\text{dB}$	15	80	-	kHz
	Response time (Rise)	t_r	$V_{CE}=2\text{V}$ $I_C=2\text{mA}$ $R_L=100\ \Omega$	-	4	18	μs
	Response time (Fall)	t_f		-	3	18	μs

(Fig. 1) Forward current vs. ambient temperature

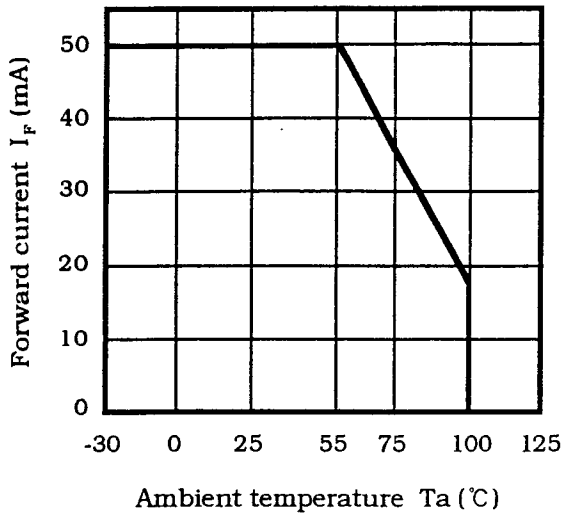

(Fig. 2) Diode power dissipation vs. ambient temperature

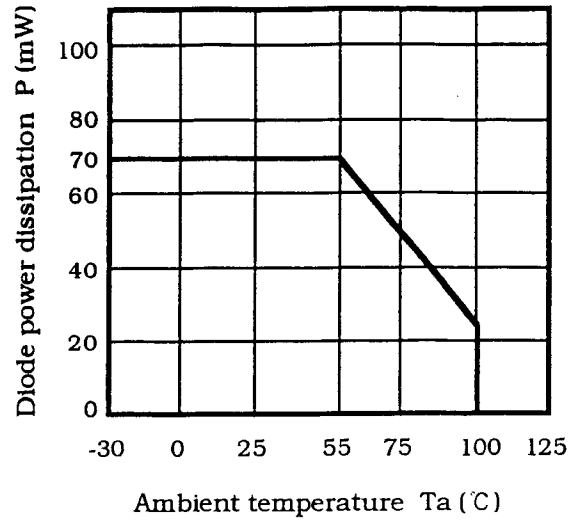

(Fig. 3) Collector power dissipation vs. ambient temperature

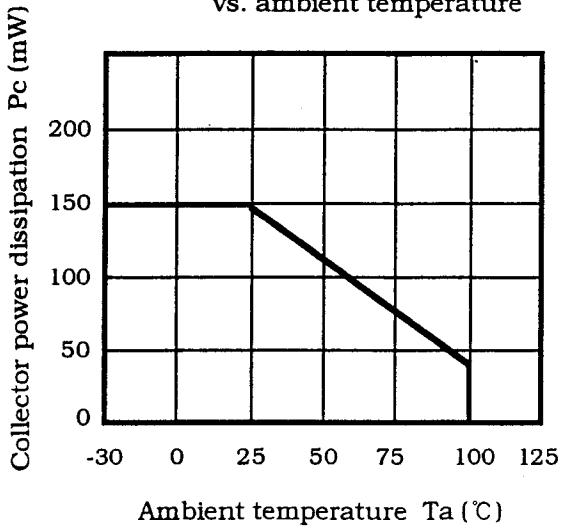

(Fig. 4) Total power dissipation vs. ambient temperature

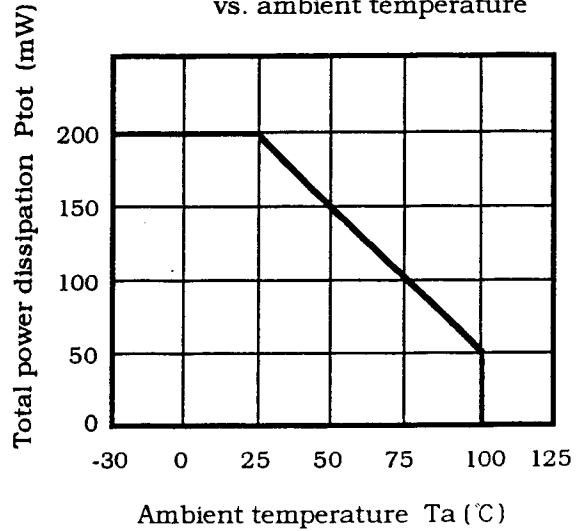

(Fig. 5) Peak forward current vs. duty ratio

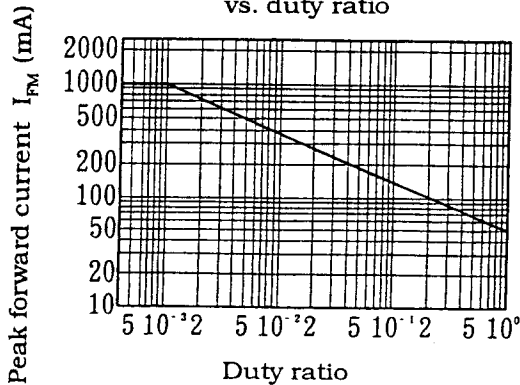

Pulse width ≤ 100 μs
Ta = 25°C

4. Reliability

The reliability of products shall satisfy items listed below.

Confidence level : 90%
LTPD : 10%/20%

Test Items	Test Conditions *1	Failure Judgement Criteria	Samples (n)
			Defective(C)
Solderability *2	230°C, 5 s	—	n=11, C=0
Soldering heat	260°C, 10 s	$V_F > U \times 1.2$ $I_{CEO} > U \times 2$ $I_C < L \times 0.7$ $V_{CE(sat)} > U \times 1.2$ U : Upper specification limit L : Lower specification limit	n=11, C=0
Terminal strength (Tension)	Weight : 5N 5 s/each terminal		n=11, C=0
Terminal strength (Bending) *3	Weight : 2.5N 2 times/each terminal		n=11, C=0
Mechanical shock	15000m/s ² , 0.5ms 3 times/±X, ±Y, ±Z direction		n=11, C=0
Variable frequency vibration	100 to 2000 to 100Hz/4min 200m/s ² 4 times/ X, Y, Z direction		n=11, C=0
Temperature cycling	1 cycle -55°C to +125°C (30min) (30min) 20 cycles test		n=22, C=0
High temp. and high humidity storage	+60°C, 90%RH, 1000h		n=22, C=0
High temp. storage	+125°C, 1000h		n=22, C=0
Low temp. storage	-55°C, 1000h		n=22, C=0
Operation life	$I_F = \pm 50\text{mA}$, $P_{tot} = 200\text{mW}$ $T_a = 25^\circ\text{C}$, 1000h		n=22, C=0

*1 Test method, conforms to JIS C 7021.

*2 Solder shall adhere at the area of 95% or more of immersed portion of lead, and pin hole or other holes shall not be concentrated on one portion.

*3 Terminal bending direction is shown below.

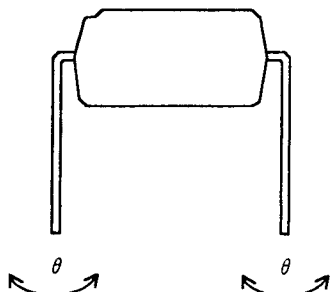

5. Outgoing inspection

5.1 Inspection items

(1) Electrical characteristics

 V_F , I_{CEO} , $V_{CE(sat)}$, I_c , R_{iso} , V_{iso}

(2) Appearance

5.2 Sampling method and Inspection level

A single sampling plan, normal inspection level II based on ISO 2859 is applied. The AQL according to the inspection items are shown below.

Defect	Inspection item	AQL (%)
Major defect	Electrical characteristics Unreadable marking	0.065
Minor defect	Appearance defect except the above mentioned.	0.25

Precautions for Photocouplers

1 For cleaning

- (1) Solvent cleaning : Solvent temperature 45°C or less
Immersion for 3 min or less
- (2) Ultrasonic cleaning : The effect to device by ultrasonic cleaning differs
by cleaning bath size, ultrasonic power
output, cleaning time, PWB size or device mounting
condition etc. Please test it in actual using condition
and confirm that doesn't occur any defect before starting
the ultrasonic cleaning.
- (3) Applicable solvent : Ethyl alcohol, Methyl alcohol, Isopropyl alcohol

In case when the other solvent is used, there are cases that
the packaging resin is eroded. Please use the other solvent
after thorough confirmation is performed in actual using condition.

2. The LED used in the Photocoupler generally decreases the light emission power
by operation. In case of long operation time, please design the circuit with considering
the degradation of the light emission power of the LED. (50%/5years)

3. Precautions for Soldering Photocouplers

- (1) In case of soldering to lead
260°C 10 s or less

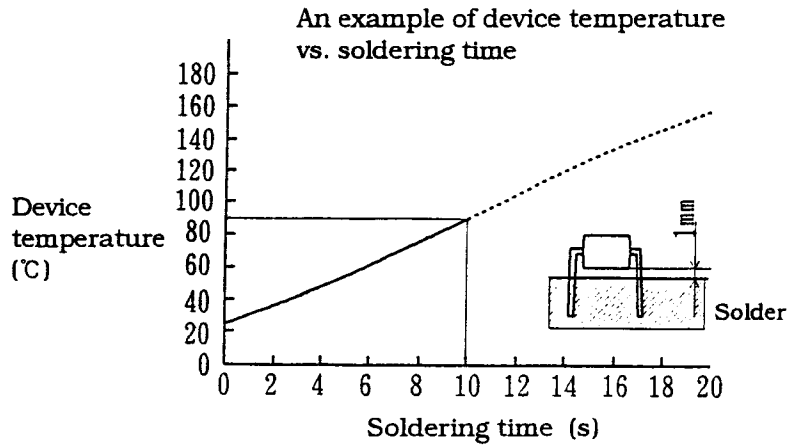

- (2) If solder reflow :

It is recommended that only one soldering be done at the temperature and the time within the temperature profile as shown in the figure before.

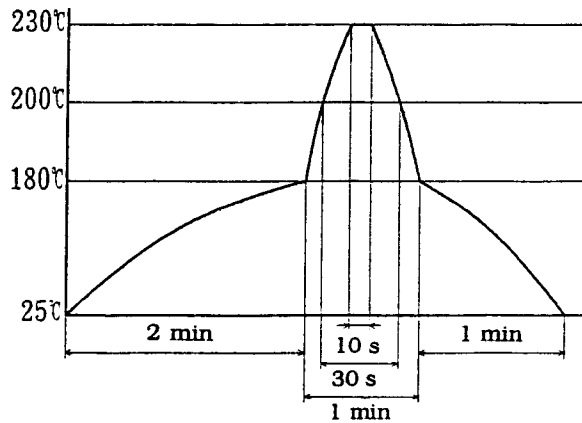

- (3) Other precautions

An infrared lamp used to heat up for soldering may cause a localized temperature rise in the resin. So keep the package temperature within that specified in Item (2). Also avoid immersing the resin part in the solder.

This datasheet has been downloaded from:

www.DatasheetCatalog.com

Datasheets for electronic components.