

FRED Module

 $V_{RRM} = 1200\text{ V}$
 $I_{FAV} = 75\text{ A}$
 $t_{rr} = 230\text{ ns}$

Fast Recovery Epitaxial Diode

Part number

MEA 75-12DA
 MEK 75-12DA
 MEE 75-12DA

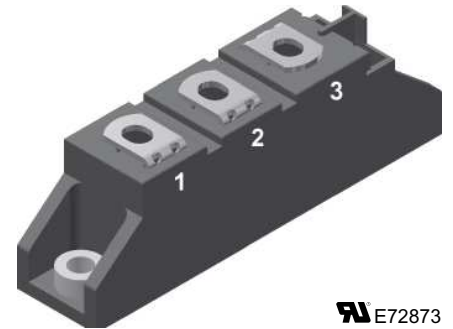

 E72873
 Backside: isolated

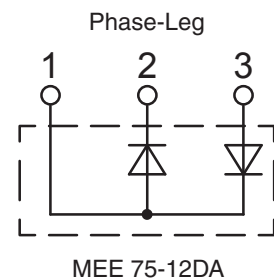
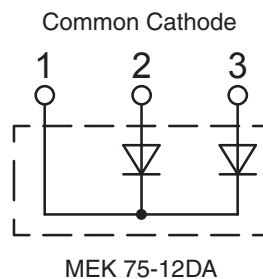
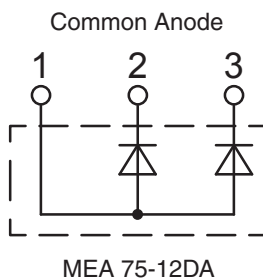

Features / Advantages:

- Planar passivated chips
- Low switching losses
- Soft recovery behaviour
- High reliability circuit operation
- Low voltage peaks for reduced protection circuits
- Low noise switching
- Low losses

Applications:

- Antiparallel diode for high frequency switching devices
- Free wheeling diode in converters and motor control circuits
- Inductive heating and melting
- Uninterruptible power supplies (UPS)
- Ultrasonic cleaners and welders

Package: TO-240AA

- Isolation voltage: 4800 V~
- Industry standard outline
- RoHS compliant
- Height: 30 mm
- Base plate: DCB ceramic
- Reduced weight
- Advanced power cycling

Disclaimer Notice

Information furnished is believed to be accurate and reliable. However, users should independently evaluate the suitability of and test each product selected for their own applications. Littelfuse products are not designed for, and may not be used in, all applications. Read complete Disclaimer Notice at www.littelfuse.com/disclaimer-electronics.



| Diode | | | | Ratings | | | |
|-------------|--|--|-------------------------|---------|------|------------------|-----|
| Symbol | Definitions | Conditions | min. | typ. | max. | | |
| V_{RSM} | max. non-repetitive reverse blocking voltage | | $T_{VJ} = 25^{\circ}C$ | | 1200 | V | |
| V_{RRM} | max. repetitive reverse blocking voltage | | $T_{VJ} = 25^{\circ}C$ | | 1200 | V | |
| I_R | reverse current | $V_R = V_{RRM}$ $V_R = 0.8 \cdot V_{RRM}$ $V_R = 0.8 \cdot V_{RRM}$ | $T_{VJ} = 25^{\circ}C$ | | 2 | mA | |
| | | | $T_{VJ} = 25^{\circ}C$ | | 0.5 | mA | |
| | | | $T_{VJ} = 125^{\circ}C$ | | 34 | mA | |
| V_F | forward voltage | $I_F = 100 A$ $I_F = 300 A$ | $T_{VJ} = 25^{\circ}C$ | | 2.17 | V | |
| | | | $T_{VJ} = 125^{\circ}C$ | | 1.85 | V | |
| | | | $T_{VJ} = 25^{\circ}C$ | | 2.64 | V | |
| | | | $T_{VJ} = 125^{\circ}C$ | | 2.58 | V | |
| I_{FRMS} | RMS forward current | | $T_C = 75^{\circ}C$ | | 107 | A | |
| I_{FAV} ① | average forward current | $T_C = 75^{\circ}C$ rectangular, d = 0.5 | $T_{VJ} = 150^{\circ}C$ | | 75 | A | |
| V_{TO} | threshold voltage | for power-loss calculations only | $T_{VJ} = T_{VJM}$ | | 1.48 | V | |
| r_T | slope resistance | | | | 3.65 | m Ω | |
| R_{thJC} | thermal resistance junction to case | | | 0.10 | 0.45 | K/W | |
| R_{thCH} | thermal resistance junction to heatsink | | | | | | K/W |
| P_{tot} | | | $T_C = 25^{\circ}C$ | | 280 | W | |
| I_{FSM} | max. surge forward current | t = 10 ms (50 Hz), sine t = 8.3 ms (60 Hz), sine t = 10 ms (50 Hz), sine t = 8.3 ms (60 Hz), sine | $T_{VJ} = 45^{\circ}C$ | | 1200 | A | |
| | | | | | 1300 | A | |
| | | | $T_{VJ} = 150^{\circ}C$ | | 1080 | A | |
| | | | | | 1170 | A | |
| I^2t | I^2t value for fusing | t = 10 ms (50 Hz), sine t = 8.3 ms (60 Hz), sine t = 10 ms (50 Hz), sine t = 8.3 ms (60 Hz), sine | $T_{VJ} = 45^{\circ}C$ | | 7200 | A ² s | |
| | | | | | 7100 | A ² s | |
| | | | $T_{VJ} = 150^{\circ}C$ | | 5800 | A ² s | |
| | | | | | 5700 | A ² s | |
| t_{rr} | max. reverse recovery current | $I_F = 70 A; V_R = 600 V$ -di/dt = 400 A/ μ s; L \leq 0.05 μ H | $T_{VJ} = 25^{\circ}C$ | | 140 | 200 | ns |
| | | | $T_{VJ} = 100^{\circ}C$ | | 230 | 300 | ns |
| I_{RM} | reverse recovery time | | $T_{VJ} = 25^{\circ}C$ | | 25 | 30 | A |
| | | | $T_{VJ} = 100^{\circ}C$ | | 33 | 40 | A |

① I_{FAVM} rating includes reverse blocking losses at T_{VJM} , $V_R = 0.8 V_{RRM}$, duty cycle d = 0.5



| Package TO-240AA | | | Ratings | | | |
|------------------|--|----------------------|-------------------------------------|------|------|----|
| Symbol | Definitions | Conditions | min. | typ. | max. | |
| I_{RMS} | RMS current | per terminal | | | 200 | A |
| T_{VJ} | virtual junction temperature | | -40 | | 150 | °C |
| T_{op} | operation temperature | | -40 | | 125 | °C |
| T_{stg} | storage temperature | | -40 | | 125 | °C |
| Weight | | | | 76 | | g |
| M_D | mounting torque | | 2.5 | | 4 | Nm |
| M_T | terminal torque | | 2.5 | | 4 | Nm |
| $d_{Spp/App}$ | creepage distance on surface striking distance through air | terminal to terminal | 13.0 | 9.7 | | mm |
| $d_{Spb/Apb}$ | | terminal to backside | 16.0 | 16.0 | | mm |
| V_{ISOL} | isolation voltage | t = 1 second | 50/60 Hz, RMS; $I_{ISOL} \leq 1$ mA | | 4800 | V |
| | | t = 1 minute | | | 4000 | V |

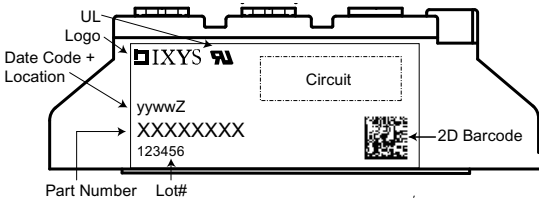

| Ordering | Part Name | Marking on Product | Delivering Mode | Base Qty | Ordering Code |
|----------|-------------|--------------------|-----------------|----------|---------------|
| Standard | MEA 75-12DA | MEA 75-12DA | Box | 36 | 469130 |
| Standard | MEK 75-12DA | MEK 75-12DA | Box | 36 | 468541 |
| Standard | MEE 75-12DA | MEE 75-12DA | Box | 36 | 469297 |

Outlines TO-240AA

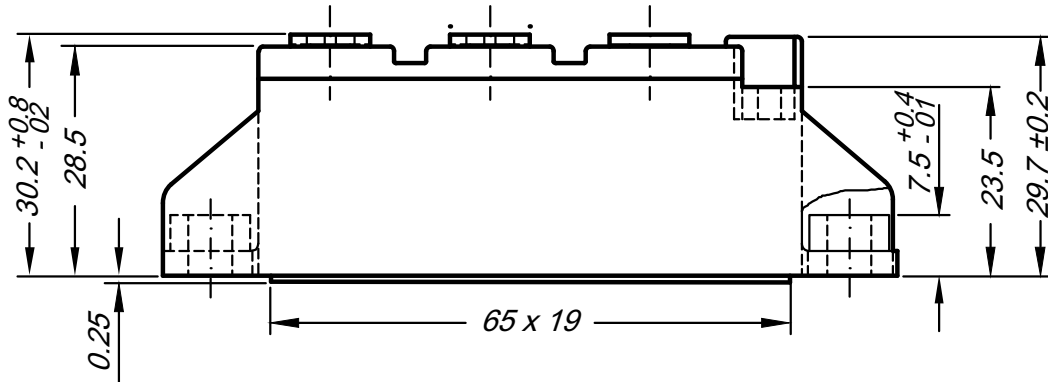

General tolerance: DIN ISO 2768 class „c“

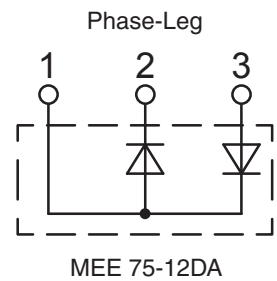
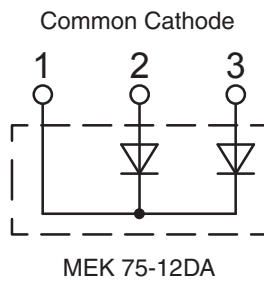
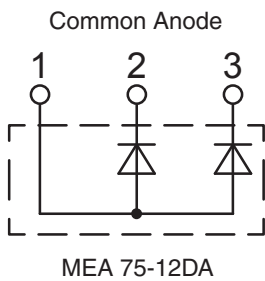
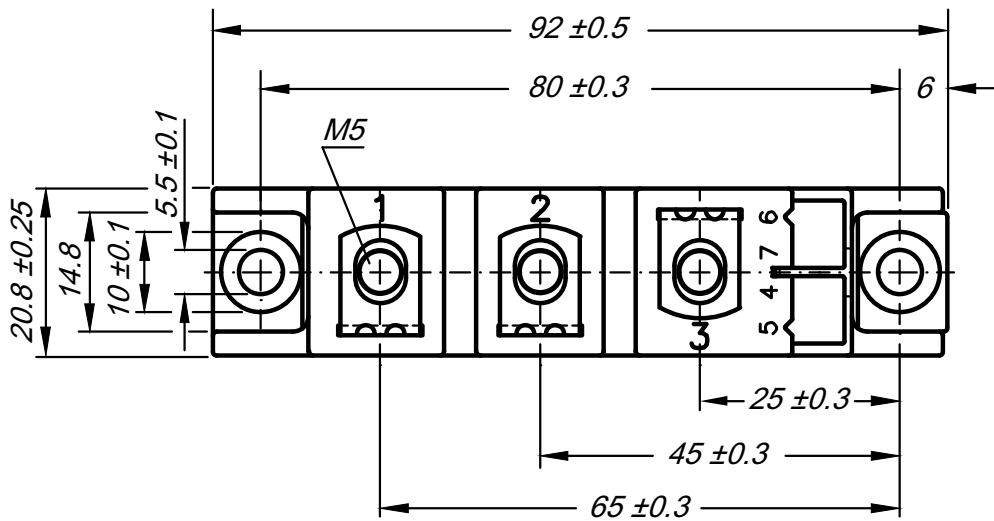

Curves

 Fig. 1 Typ. forward current I_F vs. voltage drop V_F per leg

 Fig. 2 Typ. reverse recovery charge Q_r versus $-di_F/dt$

 Fig. 3 Typ. peak reverse current I_{RM} versus $-di_F/dt$

 Fig. 4 Typ. dynamic parameters Q_r , I_{RM} vs. junction temperature T_{VJ}

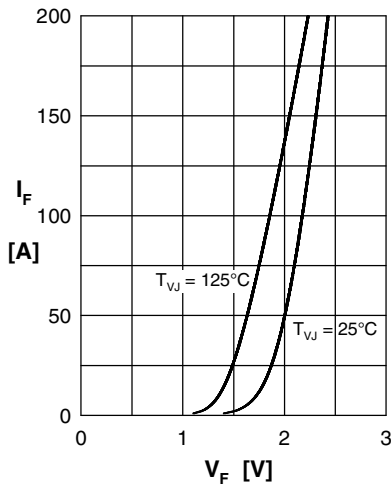
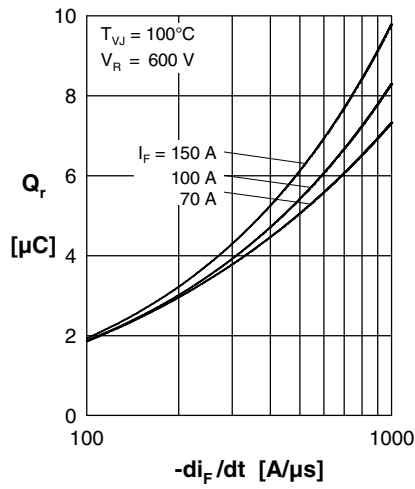
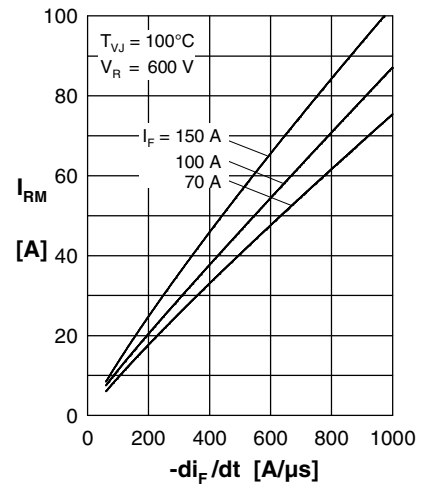
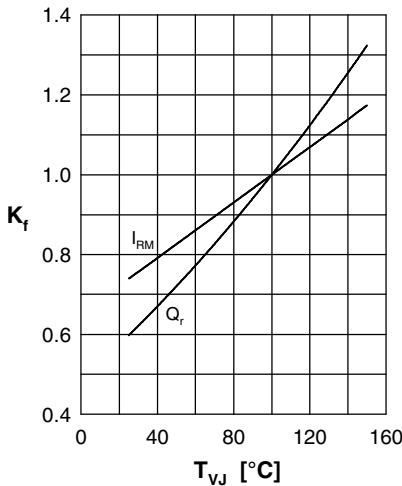
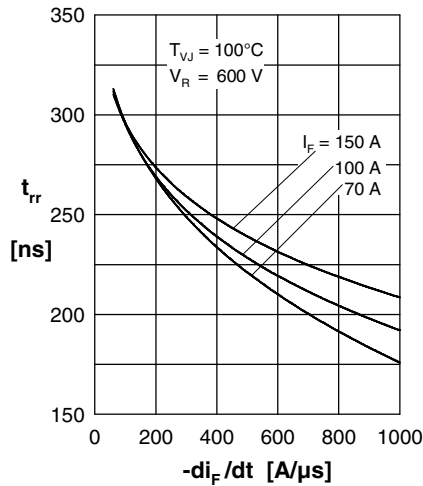
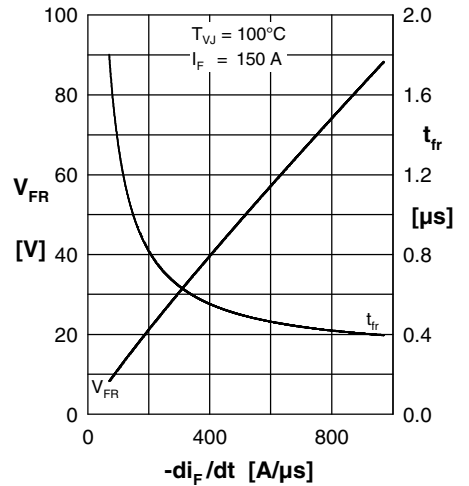
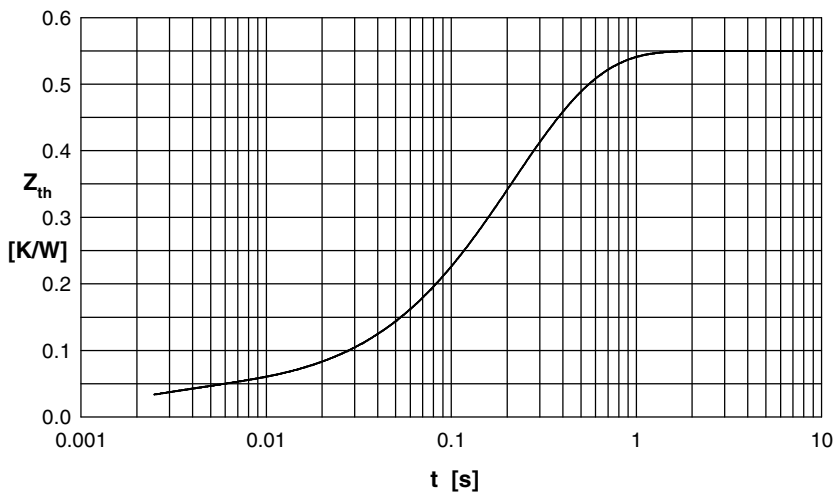
 Fig. 5 Typ. recovery time t_{rr} versus $-di_F/dt$

 Fig. 6 Typ. peak forward voltage V_{FR} and t_{fr} versus $-di_F/dt$

Fig. 7 Typ. transient thermal impedance junction to heatsink

 Constants for Z_{thJS} calculation:

| i | R_{thi} (K/W) | t_i (s) |
|---|-----------------|-----------|
| 1 | 0.037 | 0.002 |
| 2 | 0.138 | 0.134 |
| 3 | 0.093 | 0.250 |
| 4 | 0.282 | 0.274 |