

ZS4728A THRU ZS4764A

List

List..... 1

Package outline..... 2

Features..... 2

Mechanical data..... 2

Maximum ratings 2

Electrical characteristics..... 3

Rating and characteristic curves..... 4~5

Pinning information..... 6

Suggested solder pad layout..... 6

Packing information..... 7

Reel packing..... 8

Suggested thermal profiles for soldering processes..... 8

High reliability test capabilities..... 9

ZS4728A THRU ZS4764A

1000mW Surface Mount Zener Diodes 3.3V-100V

Features

- Batch process design, excellent power dissipation offers better reverse leakage current and thermal resistance
- Standard zener voltage tolerance $\pm 5\%$
- Low inductance
- Low profile package
- Built-in strain relief
- Lead-free parts meet RoHS requirements
- Suffix "-H" indicates Halogen free parts, ex. ZS4728A-H

Mechanical data

- Epoxy : UL94-V0 rated flame retardant
- Case : Molded plastic, JEDEC DO-214AC / SMA
- Terminals :Plated terminals, solderable per MIL-STD-750, Method 2026
- Polarity : Indicated by cathode band
- Mounting Position : Any
- Weight : Approximated 0.05 gram

Package outline

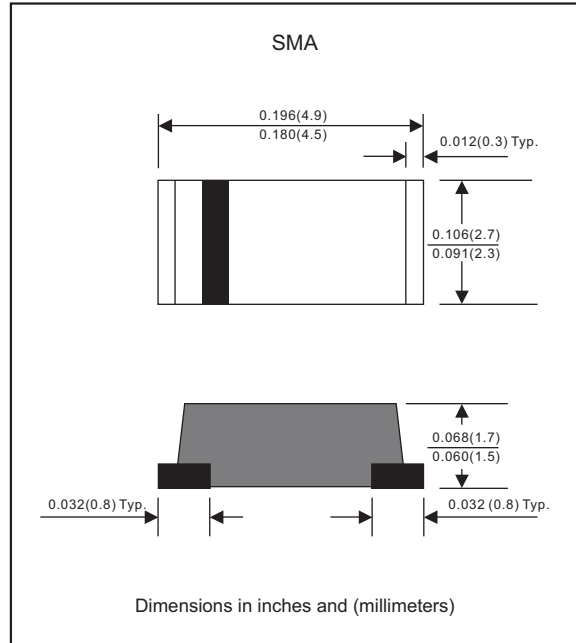

Maximum ratings (at $T_A=25^\circ\text{C}$ unless otherwise noted)

Parameter	Conditions	Symbol	MIN.	TYP.	MAX.	Unit
Forward voltage	$I_F=200\text{mA}$	V_F			1.20	V
Power dissipation	$T_L=75^\circ\text{C}$	P_D			1000	mW
Thermal resistance	Junction to case (Note 1) Junction to ambient (Note 1)	$R_{\theta JC}$ $R_{\theta JA}$		30 50		$^\circ\text{C/W}$
Operating junction temperature range		T_J	-55		+150	$^\circ\text{C}$
Storage temperature range		T_{STG}	-65		+175	$^\circ\text{C}$

Note 1: Mounted on 0.2"x0.2"(5x5mm)FR-4 PCB

ZS4728A THRU ZS4764A

Electrical characteristics (at $T_A=25^\circ\text{C}$ unless otherwise noted)

Part No.	Marking code	Zener voltage			Test current	Zener impedance			Leakage current		Maximum Surge current
		$V_Z @ I_{ZT}(\text{Volts})$			I_{ZT}	$Z_{ZT} @ I_{ZT}$	$Z_{ZK} @ I_{ZK}$	I_{ZK}	I_R	V_R	I_{surge}
		Min.	Nom.	Max.	mA	(Ω)Max	(Ω)Max	mA	(μA)Max	Volts	mApk
ZS4728A	Z3V3	3.14	3.3	3.47	76	10	400	1.00	100	1.0	1380
ZS4729A	Z3V6	3.42	3.6	3.78	69	10	400	1.00	100	1.0	1260
ZS4730A	Z3V9	3.71	3.9	4.10	64	9	400	1.00	50	1.0	1190
ZS4731A	Z4V3	4.09	4.3	4.52	58	9	400	1.00	10	1.0	1070
ZS4732A	Z4V7	4.47	4.7	4.94	53	8	500	1.00	10	1.0	970
ZS4733A	Z5V1	4.85	5.1	5.36	49	7	550	1.00	10	1.0	890
ZS4734A	Z5V6	5.32	5.6	5.88	45	5	600	1.00	10	2.0	810
ZS4735A	Z6V2	5.89	6.2	6.51	41	2	700	1.00	10	3.0	730
ZS4736A	Z6V8	6.46	6.8	7.14	37	3.5	700	1.00	10	4.0	660
ZS4737A	Z7V5	7.13	7.5	7.88	34	4.0	700	0.50	10	5.0	605
ZS4738A	Z8V2	7.79	8.2	8.61	31	4.5	700	0.50	10	6.0	550
ZS4739A	Z9V1	8.65	9.1	9.56	28	5	700	0.50	10	7.0	500
ZS4740A	Z10	9.50	10	10.50	25	7	700	0.25	10	7.6	454
ZS4741A	Z11	10.45	11	11.55	23	8	700	0.25	5	8.4	414
ZS4742A	Z12	11.40	12	12.60	21	9	700	0.25	5	9.1	380
ZS4743A	Z13	12.35	13	13.65	19	10	700	0.25	5	9.9	344
ZS4744A	Z15	14.25	15	15.75	17	14	700	0.25	5	11.4	304
ZS4745A	Z16	15.20	16	16.80	15.5	16	700	0.25	5	12.2	285
ZS4746A	Z18	17.10	18	18.90	14	20	750	0.25	5	13.7	250
ZS4747A	Z20	19.00	20	21.00	12.5	22	750	0.25	5	15.2	225
ZS4748A	Z22	20.90	22	23.10	11.5	23	750	0.25	5	16.7	205
ZS4749A	Z24	22.80	24	25.20	10.5	25	750	0.25	5	18.2	190
ZS4750A	Z27	25.65	27	28.35	9.5	35	750	0.25	5	20.6	170
ZS4751A	Z30	28.50	30	31.50	8.5	40	1000	0.25	5	22.8	150
ZS4752A	Z33	31.35	33	34.65	7.5	45	1000	0.25	5	25.1	135
ZS4753A	Z36	34.20	36	37.80	7.0	50	1000	0.25	5	27.4	125
ZS4754A	Z39	37.05	39	40.95	6.5	60	1000	0.25	5	29.7	115
ZS4755A	Z43	40.85	43	45.15	6.0	70	1500	0.25	5	32.7	110
ZS4756A	Z47	44.65	47	49.35	5.5	80	1500	0.25	5	35.8	95
ZS4757A	Z51	48.45	51	53.55	5.0	95	1500	0.25	5	38.8	90
ZS4758A	Z56	53.20	56	58.80	4.5	110	2000	0.25	5	42.6	80
ZS4759A	Z62	58.90	62	65.10	4.0	125	2000	0.25	5	47.1	70
ZS4760A	Z68	64.60	68	71.40	3.7	150	2000	0.25	5	51.7	65
ZS4761A	Z75	71.25	75	78.75	3.3	175	2000	0.25	5	56.0	60
ZS4762A	Z82	77.90	82	86.10	3.0	200	3000	0.25	5	62.2	55
ZS4763A	Z91	86.45	91	95.55	2.8	250	3000	0.25	5	69.2	50
ZS4764A	Z100	95.00	100	105.0	2.5	350	3000	0.25	5	76.0	45

Note : 5% tolerance of Zener voltage

Rating and characteristic curves (ZS4728A THRU ZS4764A)

FIG.1 MAXIMUM CONTINUOUS POWER DERATING

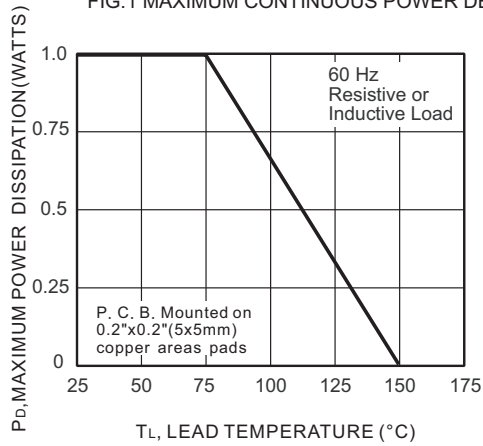

FIG.2A Range for Units to 12 Volts

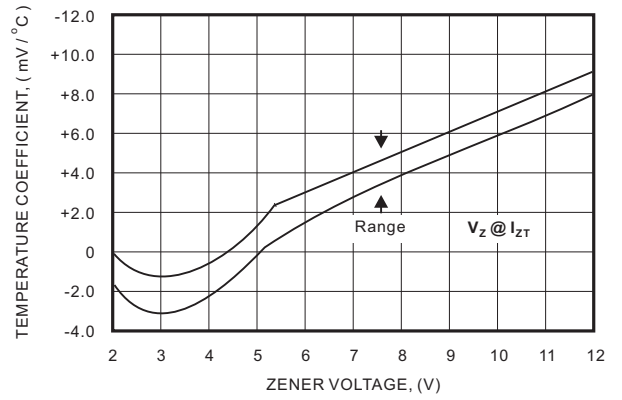

FIG.2B Range for Units to 12 to 100 Volts

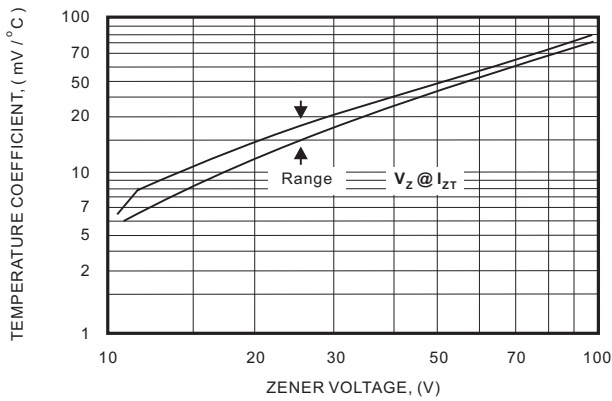
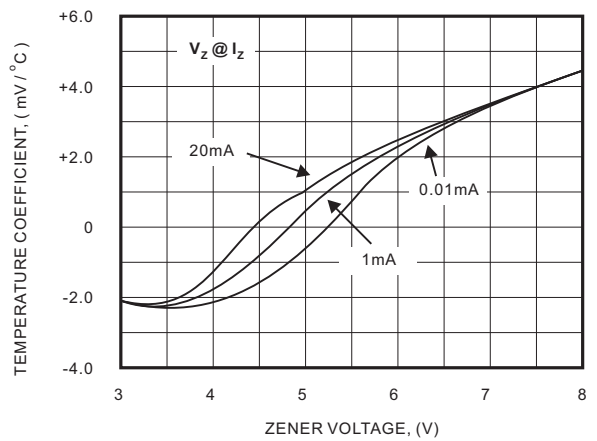
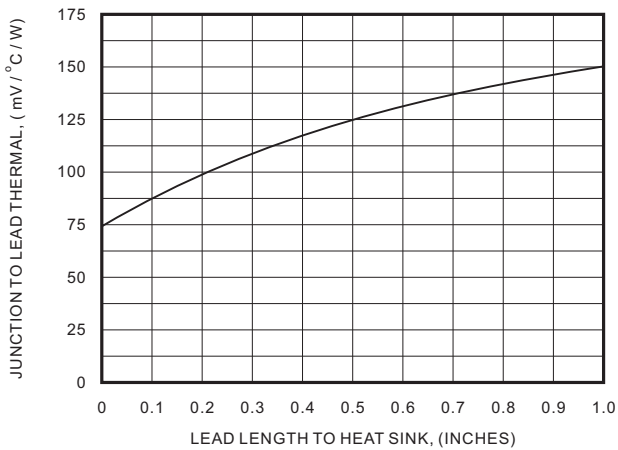

Fig. 3 Temperature Coefficients (-55°C to +150°C temperature change; 90% of the units are in the ranges indicated.)



Rating and characteristic curves (ZS4728A THRU ZS4764A)

Fig 4. Effect of Zener Voltage

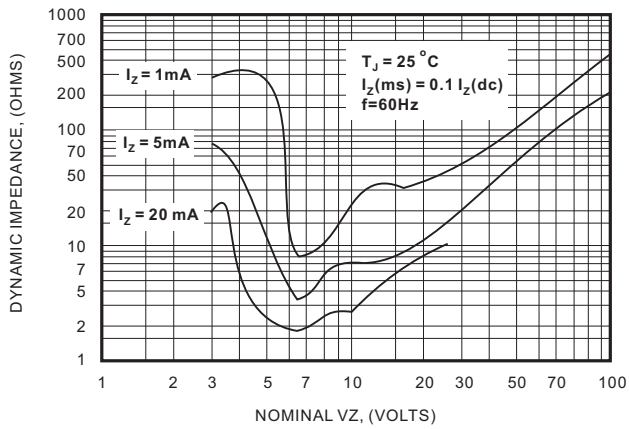

Fig 5. Capacitance Curve

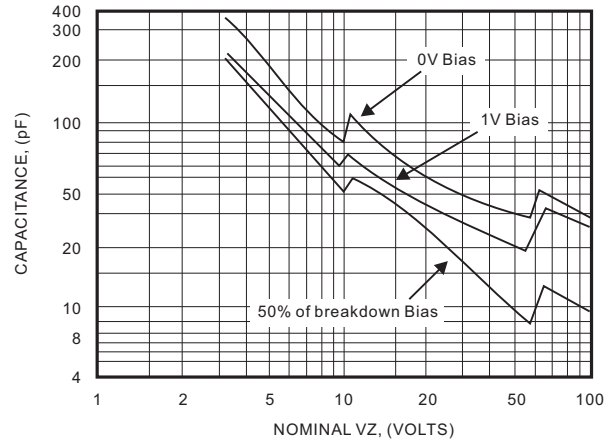
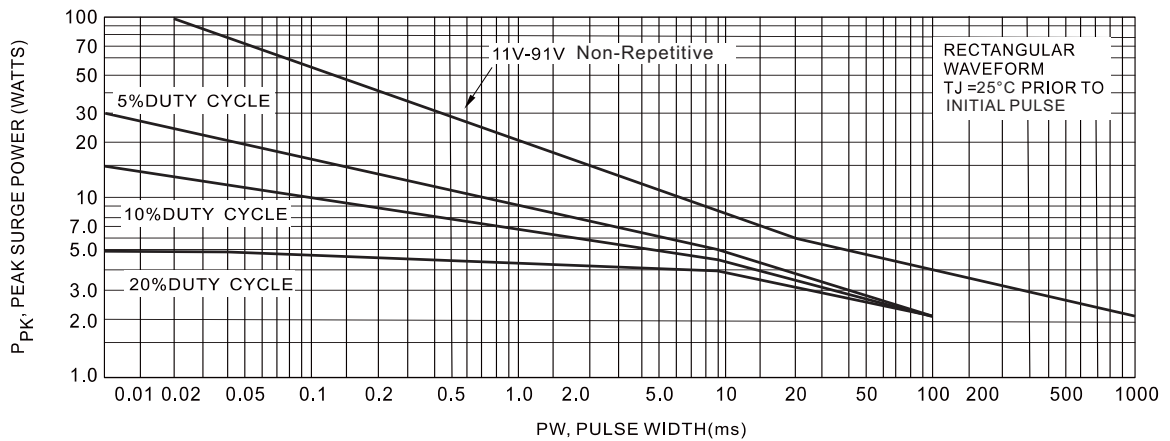



Fig 6. Maximum surge power



ZS4728A THRU ZS4764A

Pinning information

Pin	Simplified outline	Symbol
Pin1 cathode Pin2 anode		

Suggested solder pad layout

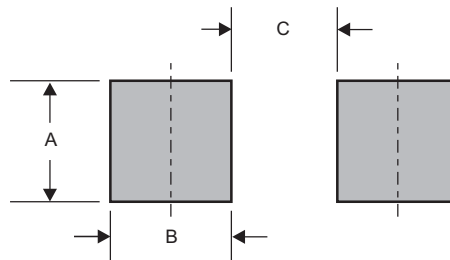

Dimensions in inches and (millimeters)

PACKAGE	A	B	C
SMA	0.110 (2.80)	0.063 (1.60)	0.087 (2.20)

ZS4728A THRU ZS4764A

Packing information

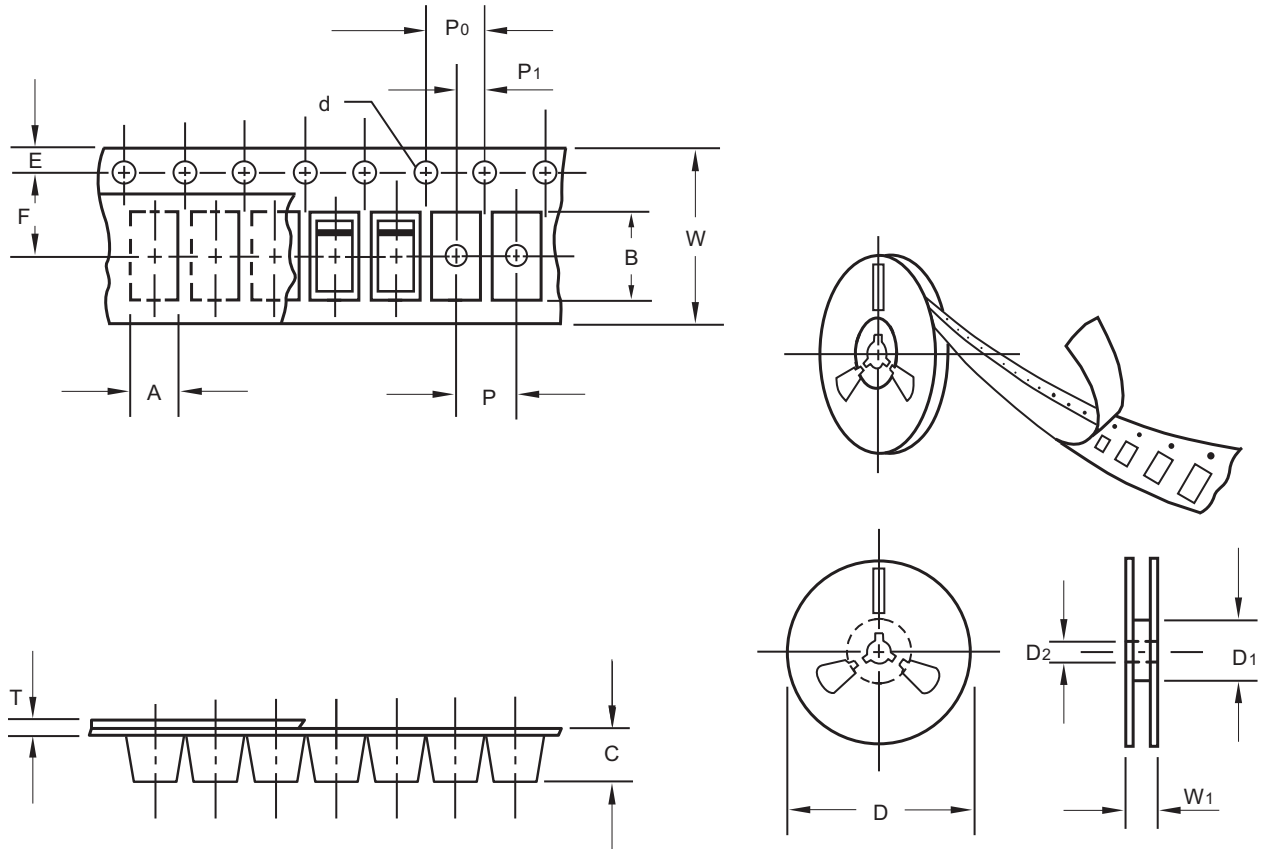

unit:mm

Item	Symbol	Tolerance	SMA
Carrier width	A	0.1	2.80
Carrier length	B	0.1	5.00
Carrier depth	C	0.1	1.90
Sprocket hole	d	0.1	1.50
13" Reel outside diameter	D	2.0	330.00
13" Reel inner diameter	D1	min	50.00
7" Reel outside diameter	D	2.0	178.00
7" Reel inner diameter	D1	min	62.00
Feed hole diameter	D2	0.5	13.00
Sprocket hole position	E	0.1	1.75
Punch hole position	F	0.1	5.50
Punch hole pitch	P	0.1	4.00
Sprocket hole pitch	P0	0.1	4.00
Embossment center	P1	0.1	2.00
Overall tape thickness	T	0.1	0.23
Tape width	W	0.3	12.00
Reel width	W1	1.0	18.00

Note: Devices are packed in accordance with EIA standard RS-481-A and specifications listed above.

ZS4728A THRU ZS4764A

Reel packing

PACKAGE	REEL SIZE	REEL (pcs)	COMPONENT SPACING (m/m)	BOX (pcs)	INNER BOX (m/m)	REEL DIA, (m/m)	CARTON SIZE (m/m)	CARTON (pcs)	APPROX. GROSS WEIGHT (kg)
SMA	7"	2,000	4.0	20,000	183*155*183	178	382*356*392	160,000	16.0
SMA	13"	7,500	4.0	15,000	335*335*38	330	350*330*360	120,000	14.5

Suggested thermal profiles for soldering processes

- 1.Storage environment: Temperature=5°C~40°C Humidity=55%±25%
- 2.Reflow soldering of surface-mount devices

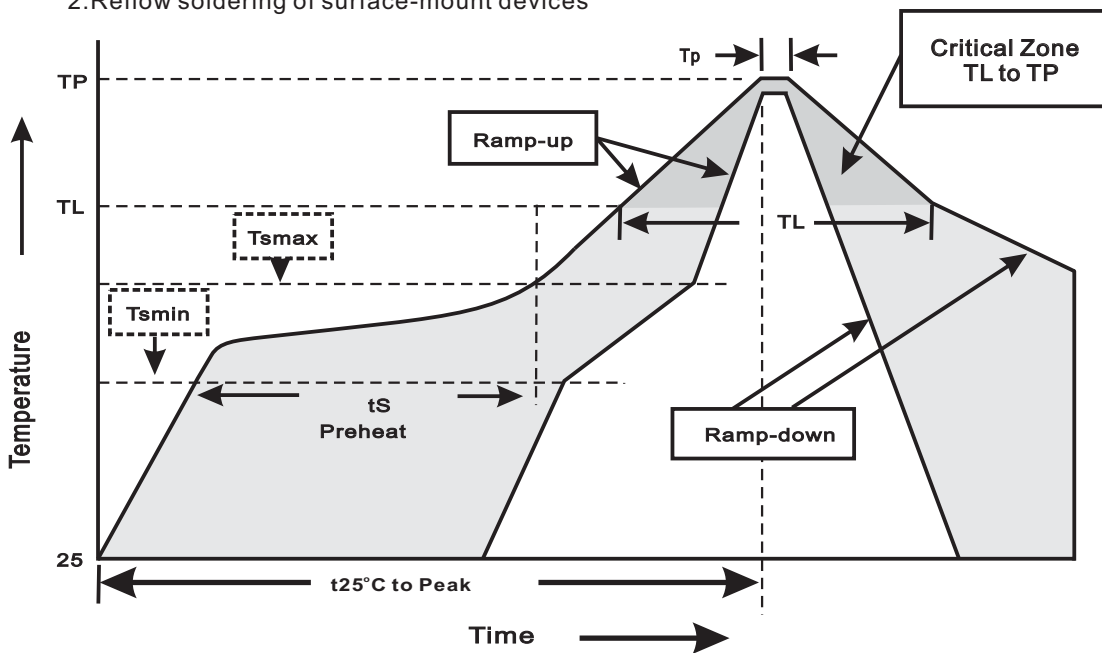

3.Reflow soldering

Profile Feature	Soldering Condition
Average ramp-up rate(TL to TP)	<3°C/sec
Preheat -Temperature Min(Tsmin) -Temperature Max(Tsmax) -Time(min to max)(ts)	150°C 200°C 60~120sec
Tsmax to TL -Ramp-upRate	<3°C/sec
Time maintained above: -Temperature(TL) -Time(tL)	217°C 60~260sec
Peak Temperature(TP)	255°C-0/+5°C
Time within 5°C of actual Peak Temperature(tP)	10~30sec
Ramp-down Rate	<6°C/sec
Time 25°C to Peak Temperature	<6minutes

ZS4728A THRU ZS4764A**High reliability test capabilities**

Item Test	Conditions	Reference
1. Solder Resistance	at 260±5°C for 10±2sec.	MIL-STD-750D METHOD-2031
2. Solderability	at 245±5°C for 5 sec.	MIL-STD-202F METHOD-208
3. High Temperature Reverse Bias	$V_z = V_{z,Nom} * 80\%$ at $T_j = 150^\circ\text{C}$ for 168 hrs.	MIL-STD-750D METHOD-1038
4. Pressure Cooker	15P _{SIG} at $T_A = 121^\circ\text{C}$ for 4 hrs.	JESD22-A102
5. Temperature Cycling	-55°C to +125°C dwelled for 30 min. and transferred for 5min. total 10 cycles.	MIL-STD-750D METHOD-1051
6. Humidity	at $T_A = 85^\circ\text{C}$, RH=85% for 1000hrs.	MIL-STD-750D METHOD-1021
7. High Temperature Storage Life	at 175°C for 1000 hrs.	MIL-STD-750D METHOD-1031