

GP1FAV30TK0F

Fiber Optic Transmitter
Square connector
With mounting hole
Protection cap type



■Description

GP1FAV30TK0F has a built-in LED with a peak light emission wavelength of 660 nm and the associated drive IC, and the input is TTL level compatible.

■Features

1. Fiber optic transmitter
(Receiver : **GP1FAV30RK0F**)
2. Square connector (JEITA RC-5720B)
3. With mounting hole
4. Protection cap type
5. Supply voltage : 3 V
6. Transfer rate : 15.5 Mb/s

■Agency approvals/Compliance

1. Compliant with JEITA RC-5720B and CP1201
2. Compliant with RoHS directive (2002/95/EC)

■Applications

AV equipment
(DVD, CD, MD players etc.)

Notice The content of data sheet is subject to change without prior notice.

In the absence of confirmation by device specification sheets, SHARP takes no responsibility for any defects that may occur in equipment using any SHARP devices shown in catalogs, data books, etc. Contact SHARP in order to obtain the latest device specification sheets before using any SHARP device.

Sheet No.: E2-A00301EN

Date Dec.01.2006

©SHARP Corporation

■ Outline Dimensions

(Unit: mm)

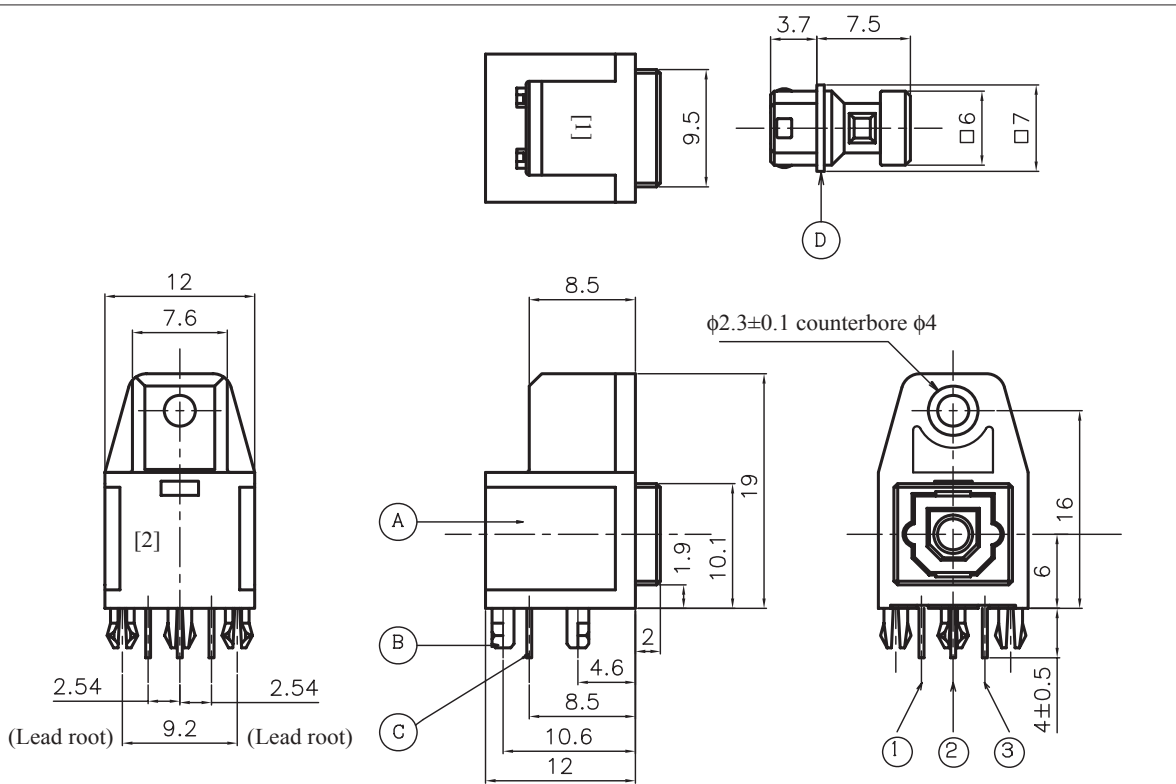

Example of mounting drawing from solder side.
Unspecified tolerance ± 0.1

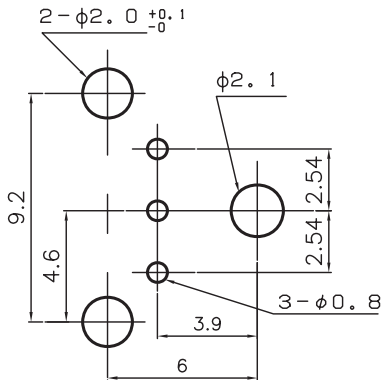

Internal Equivalent Circuit

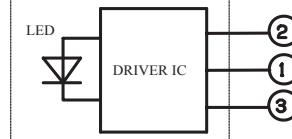

LED : AlGaInP, DRIVER IC : silicon

*1

Input conditions of V_{in} terminal are designed to conform to TTL and CMOS.
It is recommended that the output of TTL and high speed CMOS be used in the input for V_{in} terminal.

Pin Arrangement

- ① V_{in} *1
- ② V_{cc}
- ③ GND

- 1) The connector joint area complies with the square connector JEITA RC-5720B.
- 2) [1] portion : "S" mark, [2] portion : Model No. and date code shall be indicated.
- 3) Unspecified tolerance are ± 0.3
- 4) Since there are other products which has a different fixing pin shape, please make sure to confirm reference mounting drawing for this device.

[2]Portion marking

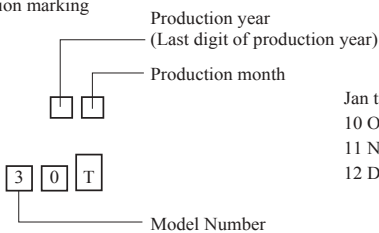

Jan to Sep: 1 - 9
10 Oct: X
11 Nov: Y
12 Dec: Z

Symbol	Description	Material
A	Holder	PBT (Color : Black)
B	Fixing pin	PBT (Color : Black)
C	Lead pin	Cu Alloy (SnCu plating)
D	Protect cap	PBT (Color : Black)

Product mass : approx. 2.2 g

■ Absolute Maximum Ratings

Parameter	Symbol	Rating	Unit	Remark
Supply voltage	V_{CC}	-0.5 to +7.0	V	
Input voltage	V_{in}	-0.5 to $V_{CC}+0.5$	V	
Operating temperature	T_{opr}	-20 to +70	°C	
Storage temperature	T_{stg}	-30 to +80	°C	
Soldering temperature *1	T_{sol}	260	°C	6 s or less/time up to 2 times.
		380	°C	4 s or less/time up to 1 time. Soldering by hand at each terminal. *2

*1 Solder at a position more than 1.6 mm away from the base of the lead terminal. Reflow is not available.

*2 Do not contact top of soldering iron to lead terminal directly.

■ Recommended Operating Conditions

Parameter	Symbol	MIN.	TYP.	MAX.	Unit	Remark
Supply voltage	V_{CC}	2.7	3.0	3.6	V	
Operating transfer rate	T	-	-	15.5	Mb/s	NRZ signal duty 50%

■ Electro-optical Characteristics

($T_a = 25\text{ °C}$, $V_{CC} = 3\text{ V}$)

Parameter	Symbol	Conditions	MIN.	TYP.	MAX.	Unit
Peak emission wavelength	λ_p		630	660	690	nm
Output optical power couple into fiber	P_C	Measurement method refer to Fig. 1	-21	-18	-15	dBm
Supply current	I_{CC}	Measurement method refer to Fig. 2	-	8	13	mA
High level input voltage	V_{iH}		2.3	-	-	V
Low level input voltage	V_{iL}	Measurement method refer to Fig. 3, 4	-	-	0.8	V
L → H delay time	t_{pLH}		-	-	180	ns
H → L delay time	t_{pHL}		-	-	180	ns
Pulse width distortion	Δt_w		-15	-	+15	ns
Jitter	Δt_j		-	1	15	ns

■ Measurement Method

Fig. 1 Output Optical Power Coupled Into Fiber

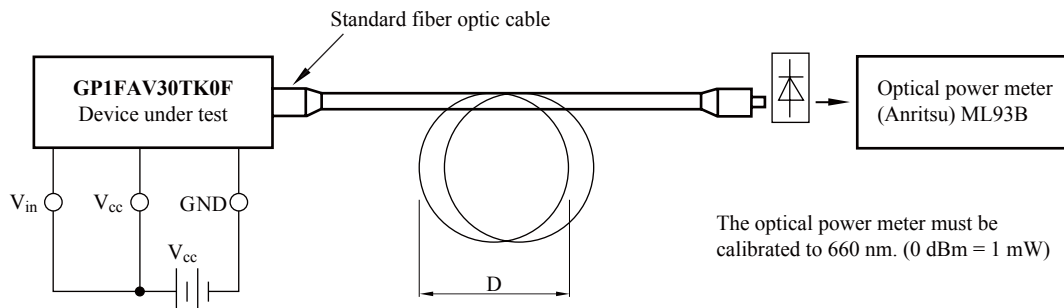

The optical power meter must be calibrated to 660 nm. (0 dBm = 1 mW)

Notes

1. $V_{cc} = 3.0$ V (State of operating)
2. To bundle up the standard fiber optic cable, make it into a loop with the diameter $D = 10$ cm or more. (The standard fiber optic cable will be specified elsewhere.)

Fig. 2 Input Voltage and Supply Current

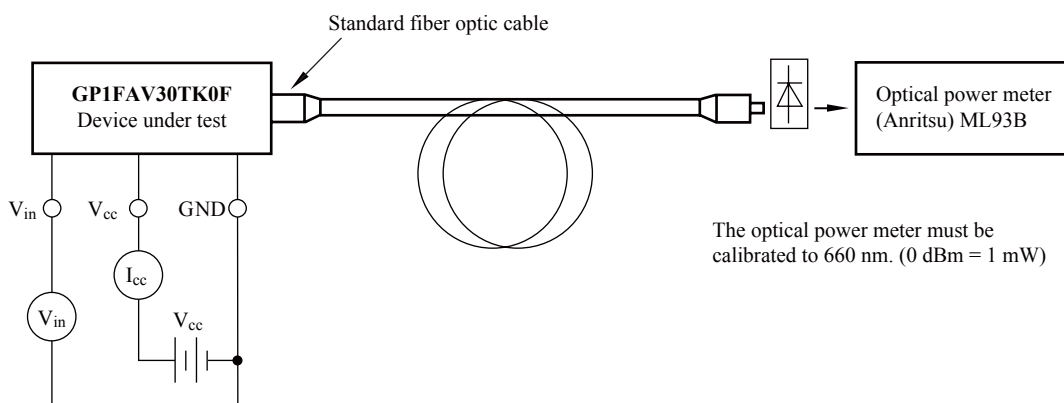

The optical power meter must be calibrated to 660 nm. (0 dBm = 1 mW)

Input conditions and judgment method

No.	Input conditions	Judgment method
1	$V_{in} = 2.3$ V or more	$-21 \leq P_C \leq -15$ dBm, $I_{CC} = 13$ mA or less
2	$V_{in} = 0.8$ V or less	$P_C \leq -36$ dBm, $I_{CC} = 13$ mA or less

Notes

$V_{cc} = 3.0$ V (State of operating)

Fig. 3 Pulse Response and Jitter

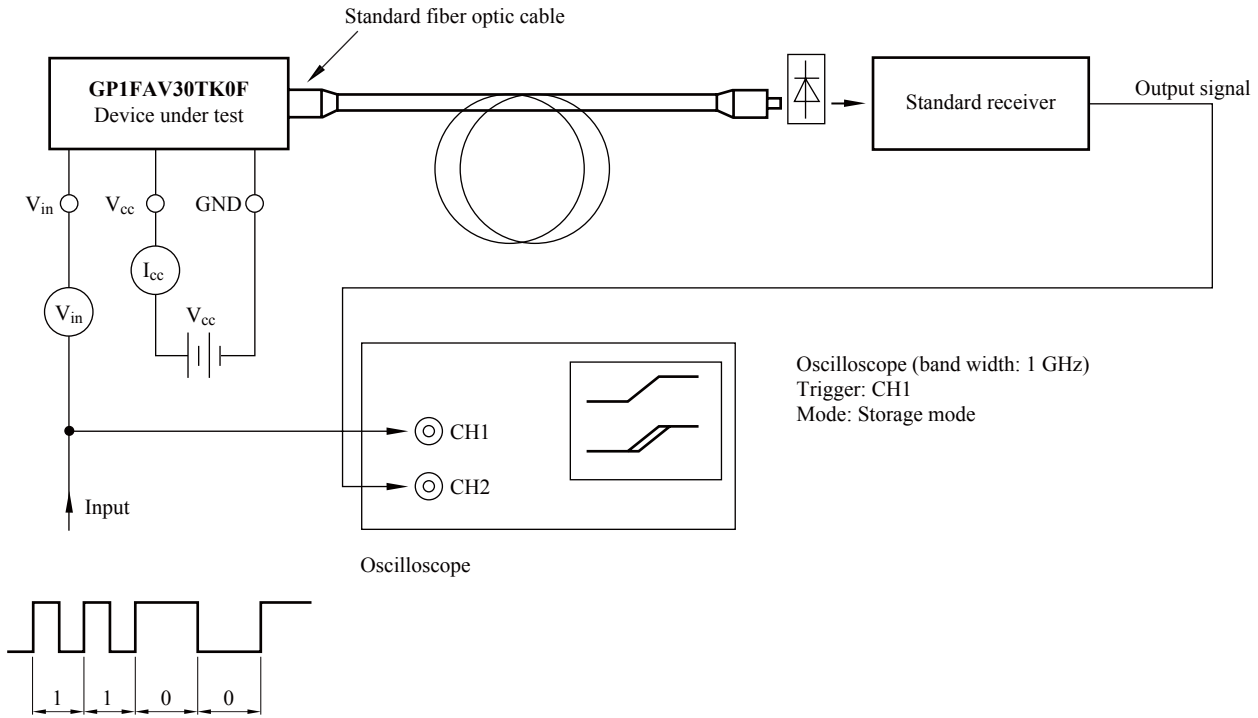

Input signal
7.75 Mb/s bi-phase PRBS signal

Fig. 4 Input Signal (7.75 Mb/s Bi-phase PRBS Signal)

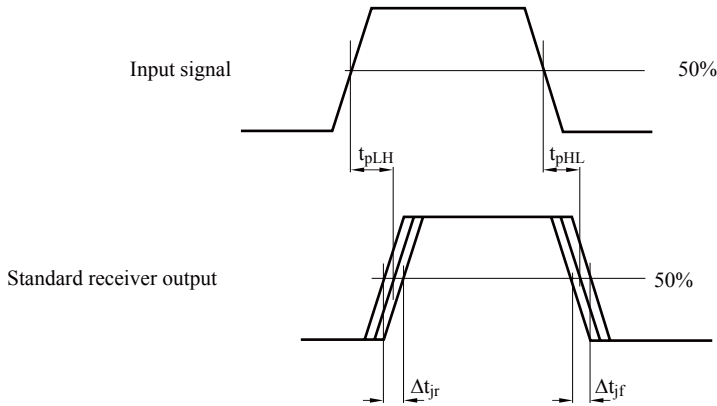

Notes

- (1) The wave form write time shall be 4 s. But do not allow the wave form to be distorted by increasing the brightness too much.
- (2) $V_{CC} = 3.0$ V (State of operating)
- (3) The probe for the oscilloscope must be more than 1 M Ω and less than 10 pF.

■Design and Production Notes

(1) Stabilization of power supply line

Please put a by-pass capacitor (0.1 μ F) close to the device at least within 7 mm of the terminal.
Please also put a 4.7 μ F capacitor across the power supply line nearby.

(2) Soldering condition

Solder at the condition within the absolute maximum ratings in this sheet. In case of using flow soldering, please make sure of the conditions of process at the flow equipment. Also, do not use reflow soldering. In case of soldering by hand, do not contact top of soldering iron to lead terminal directly. (Solder at a position more than 1.6 mm away from the base of the lead terminal.)

(3) About getting dirt and dust in the connector coupling portion

In case dirt or dust comes into the connector coupling portion, please use a blower to take it off.
Any rigid rod-like object must not be inserted since into the coupling portion.
The internal device might be damaged, resulting deteriorated characteristics.

(4) Cleaning

Do not immerse for cleaning. The solvent would get into the connector coupling portion resulting deteriorated characteristics. Should it be necessary to remove the flux, please use one of the following solvents only to be applied with a brush.

Solvent : Isopropyl alcohol, Methyl alcohol

(5) Ground during assembling

The human body and the soldering iron must be grounded against the static breakdown of the device during assembling.
Please avoid touching the device terminals as much as possible before assembling.

(6) Assembly of the device

Please fix this device with a screw. In case that this device is not fixed with a screw, stress by detaching connector of internal elements and leads can adversely affect the device's reliability. Excessive torque can deform the package and damage the optics. It can also adversely affect the device's reliability because the device is used under continuous stress. Please confirm the limit of fixing torque to the installation before fixing actually.

Recommended values

Screw : M3.0 \times 8 mm tapping screw

Fixing torque : 0.7 to 0.8 N·m

Force applied by driver etc. : 39 N or less

Note : Please contact and consult with a Sharp sales representative for any questions about above.

(7) Input signal

This product is designed intentionally based upon the signal transmission which is defined by the digital audio interface standard ; CP1201. When a signal out of JEITA standard CP-1201 is inputted to this device, there might be a case that this device can not transmit a signal correctly to receiving unit.

(8) Fixing pin

Since there are other products which has a different fixing pin shape, please make sure to confirm reference mounting drawing for this device.

(9) Damage to connector coupling portion

Please do not stress the connector coupling portion excessively since there might be a case that the shutter can't operate normally.

(10) About getting the flux into connector coupling portion

Please avoid getting a flux into connector coupling portion of this device, because there might be a case that the characteristics deteriorate the shutter can't operate normally.

● Presence of ODC etc.

This product shall not contain the following materials.

And they are not used in the production process for this product.

Regulation substances : CFCs, Halon, Carbon tetrachloride, 1.1.1-Trichloroethane (Methylchloroform)

Specific brominated flame retardants such as the PBB and PBDE are not used in this product at all.

This product shall not contain the following materials banned in the RoHS Directive (2002/95/EC).

- Lead, Mercury, Cadmium, Hexavalent chromium, Polybrominated biphenyls (PBB), Polybrominated diphenyl ethers (PBDE).

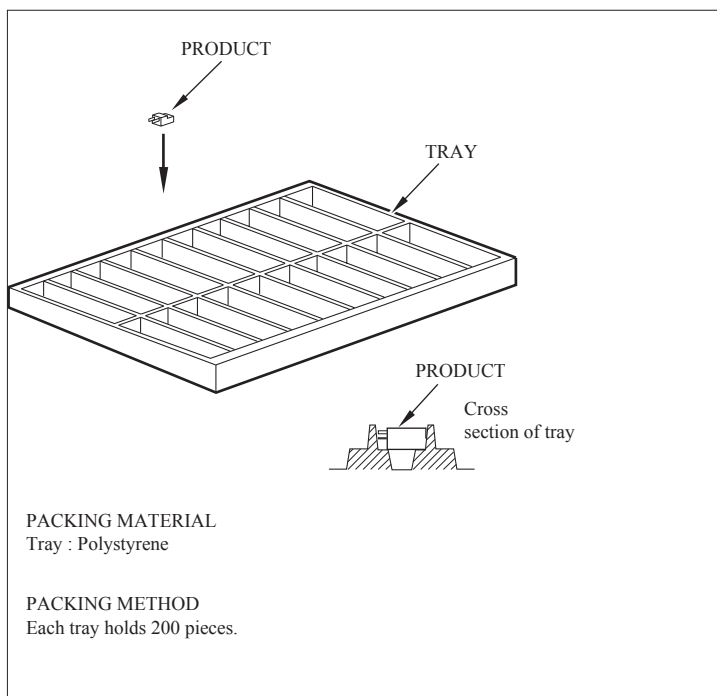
■ Packing Specifications

■ Important Notices

· The circuit application examples in this publication are provided to explain representative applications of SHARP devices and are not intended to guarantee any circuit design or license any intellectual property rights. SHARP takes no responsibility for any problems related to any intellectual property right of a third party resulting from the use of SHARP's devices.

· Contact SHARP in order to obtain the latest device specification sheets before using any SHARP device. SHARP reserves the right to make changes in the specifications, characteristics, data, materials, structure, and other contents described herein at any time without notice in order to improve design or reliability. Manufacturing locations are also subject to change without notice.

· Observe the following points when using any devices in this publication. SHARP takes no responsibility for damage caused by improper use of the devices which does not meet the conditions and absolute maximum ratings to be used specified in the relevant specification sheet nor meet the following conditions:

(i) The devices in this publication are designed for use in general electronic equipment designs such as:

- Personal computers
- Office automation equipment
- Telecommunication equipment [terminal]
- Test and measurement equipment
- Industrial control
- Audio visual equipment
- Consumer electronics

(ii) Measures such as fail-safe function and redundant design should be taken to ensure reliability and safety when SHARP devices are used for or in connection

with equipment that requires higher reliability such as:

- Transportation control and safety equipment (i.e., aircraft, trains, automobiles, etc.)
- Traffic signals
- Gas leakage sensor breakers
- Alarm equipment
- Various safety devices, etc.

(iii) SHARP devices shall not be used for or in connection with equipment that requires an extremely high level of reliability and safety such as:

- Space applications
- Telecommunication equipment [trunk lines]
- Nuclear power control equipment
- Medical and other life support equipment (e.g., scuba).

· If the SHARP devices listed in this publication fall within the scope of strategic products described in the Foreign Exchange and Foreign Trade Law of Japan, it is necessary to obtain approval to export such SHARP devices.

· This publication is the proprietary product of SHARP and is copyrighted, with all rights reserved. Under the copyright laws, no part of this publication may be reproduced or transmitted in any form or by any means, electronic or mechanical, for any purpose, in whole or in part, without the express written permission of SHARP. Express written permission is also required before any use of this publication may be made by a third party.

· Contact and consult with a SHARP representative if there are any questions about the contents of this publication.