

# BCR5KM

MEDIUM POWER USE  
INSULATED TYPE, PLANAR PASSIVATION TYPE

**BCR5KM**



- $I_T$  (RMS) ..... 5A
- $V_{DRM}$  ..... 400V / 600V
- IFGT I , IRGT I , IRGT III ..... 15mA (10mA) \*2
- UL Recognized : File No. E80271

**OUTLINE DRAWING** Dimensions in mm

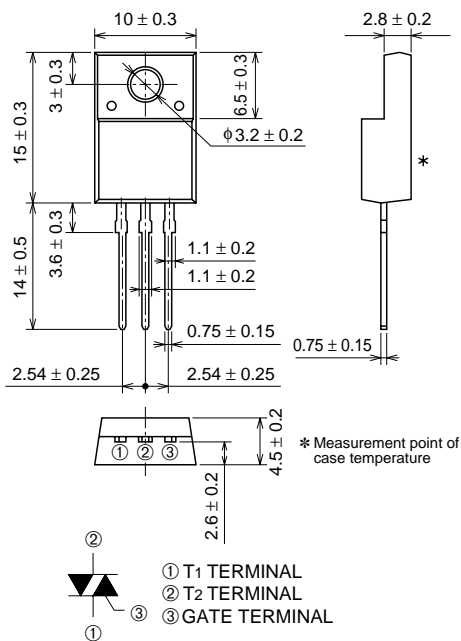

\* Measurement point of case temperature

**TO-220FN**

① T1 TERMINAL  
② T2 TERMINAL  
③ GATE TERMINAL

## APPLICATION

Control of heater such as electric rice cooker, electric pot

## MAXIMUM RATINGS

Symbol	Parameter	Voltage class		Unit
		8	12	
$V_{DRM}$	Repetitive peak off-state voltage*1	400	600	V
$V_{DSM}$	Non-repetitive peak off-state voltage*1	500	720	V

Symbol	Parameter	Conditions	Ratings	Unit
$I_T$ (RMS)	RMS on-state current	Commercial frequency, sine full wave 360° conduction, $T_c=103^\circ\text{C}$	5	A
$I_{TSM}$	Surge on-state current	60Hz sinewave 1 full cycle, peak value, non-repetitive	50	A
$I_t^2$	$I_t^2$ for fusing	Value corresponding to 1 cycle of half wave 60Hz, surge on-state current	10.4	A <sup>2</sup> s
$P_{GM}$	Peak gate power dissipation		3	W
$P_{G(AV)}$	Average gate power dissipation		0.3	W
$V_{GM}$	Peak gate voltage		10	V
$I_{GM}$	Peak gate current		2	A
$T_j$	Junction temperature		-40 ~ +125	°C
$T_{stg}$	Storage temperature		-40 ~ +125	°C
—	Weight		2.0	g
$V_{iso}$	Isolation voltage	$T_a=25^\circ\text{C}$ , AC 1 minute, T1 · T2 · G terminal to case	2000	V

\*1. Gate open.

# BCR5KM

MEDIUM POWER USE  
INSULATED TYPE, PLANAR PASSIVATION TYPE

## ELECTRICAL CHARACTERISTICS

Symbol	Parameter	Test conditions	Limits			Unit	
			Min.	Typ.	Max.		
IDRM	Repetitive peak off-state current	T <sub>j</sub> =125°C, V <sub>DRM</sub> applied	—	—	2.0	mA	
VTM	On-state voltage	T <sub>c</sub> =25°C, I <sub>TM</sub> =7A, Instantaneous measurement	—	—	1.5	V	
VFGT I	Gate trigger voltage *2	T <sub>j</sub> =25°C, V <sub>D</sub> =6V, R <sub>L</sub> =6Ω, R <sub>G</sub> =330Ω	I	—	—	1.5	V
VRGT I			II	—	—	1.5	V
VRGT III			III	—	—	1.5	V
IFGT I	Gate trigger current *2	T <sub>j</sub> =25°C, V <sub>D</sub> =6V, R <sub>L</sub> =6Ω, R <sub>G</sub> =330Ω	I	—	—	15*2	mA
IRGT I			II	—	—	15*2	mA
IRGT III			III	—	—	15*2	mA
VGD	Gate non-trigger voltage	T <sub>j</sub> =125°C, V <sub>D</sub> =1/2V <sub>DRM</sub>	0.2	—	—	V	
R <sub>th</sub> (j-c)	Thermal resistance	Junction to case *3	—	—	3.8	°C/W	
R <sub>th</sub> (j-a)	Thermal resistance	Junction to ambient	—	—	50	°C/W	

\*2. High sensitivity (IGT ≤ 10mA) is also available. (IGT item ①)  
\*3. The contact thermal resistance R<sub>th</sub> (c-f) in case of greasing is 0.5°C/W.

## PERFORMANCE CURVES

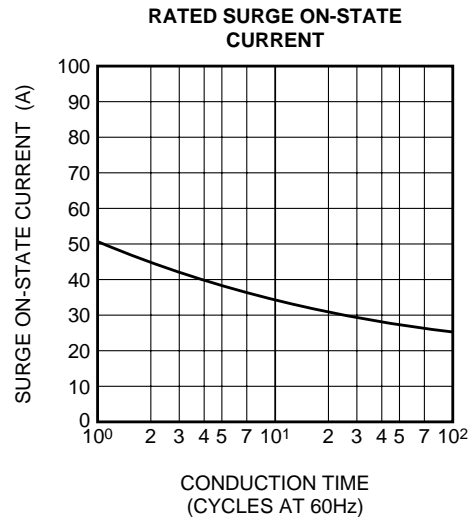
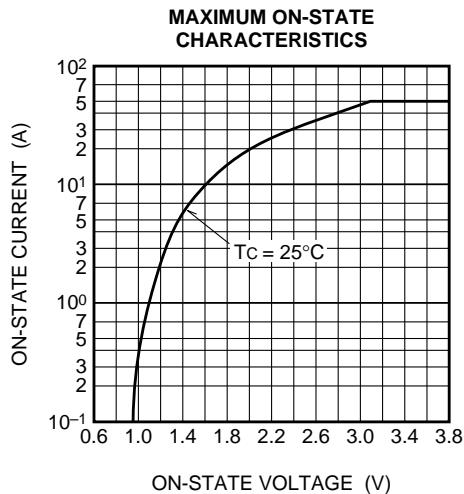

# BCR5KM

MEDIUM POWER USE  
INSULATED TYPE, PLANAR PASSIVATION TYPE

**GATE CHARACTERISTICS  
(I, II AND III)**

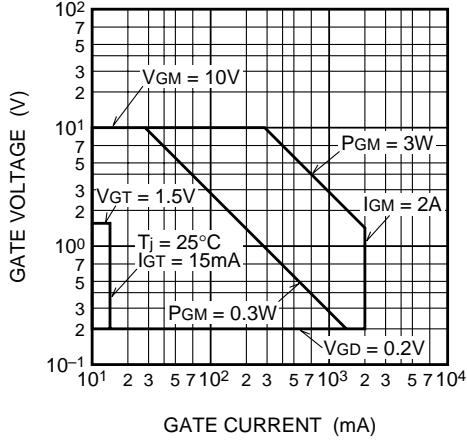

**GATE TRIGGER CURRENT VS.  
JUNCTION TEMPERATURE**

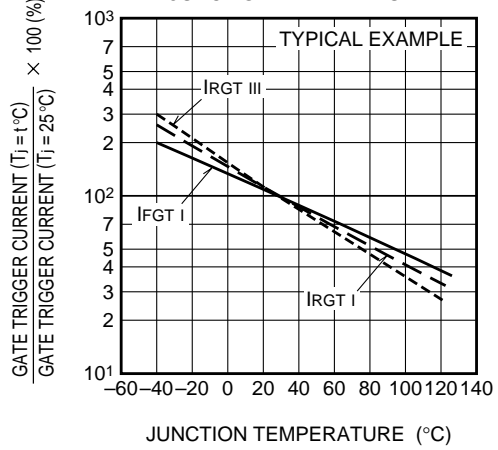

**GATE TRIGGER VOLTAGE VS.  
JUNCTION TEMPERATURE**

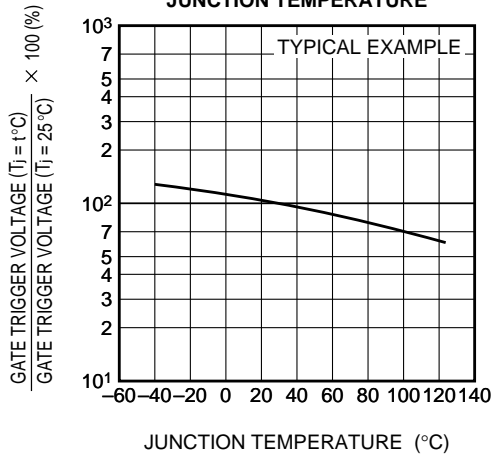

**MAXIMUM TRANSIENT THERMAL  
IMPEDANCE CHARACTERISTICS  
(JUNCTION TO CASE)**

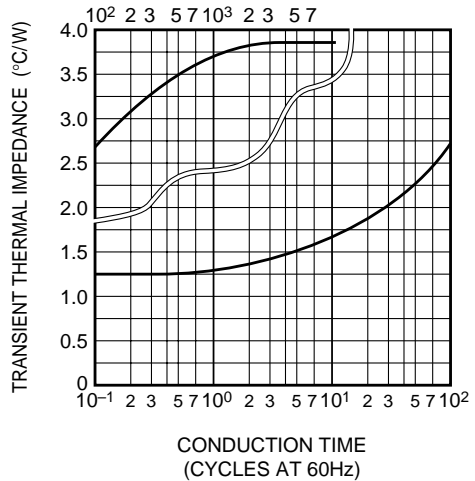

**MAXIMUM TRANSIENT THERMAL  
IMPEDANCE CHARACTERISTICS  
(JUNCTION TO AMBIENT)**

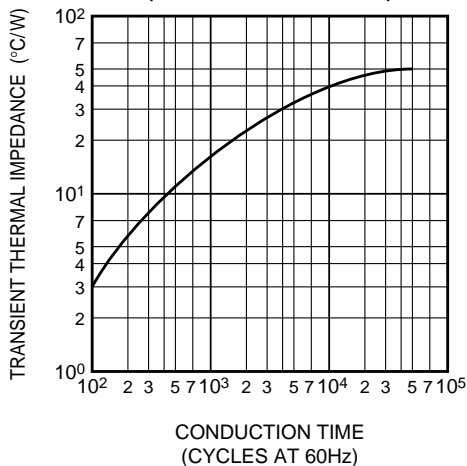

**MAXIMUM ON-STATE POWER  
DISSIPATION**

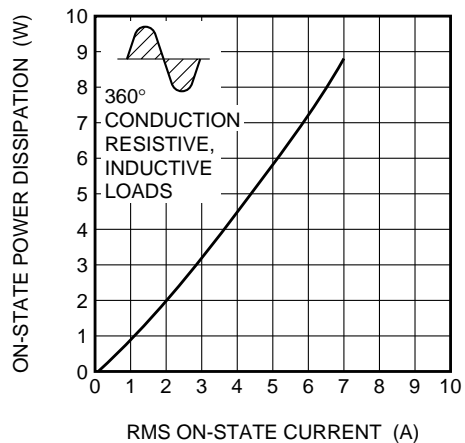

# BCR5KM

MEDIUM POWER USE  
INSULATED TYPE, PLANAR PASSIVATION TYPE

**ALLOWABLE CASE TEMPERATURE VS. RMS ON-STATE CURRENT**

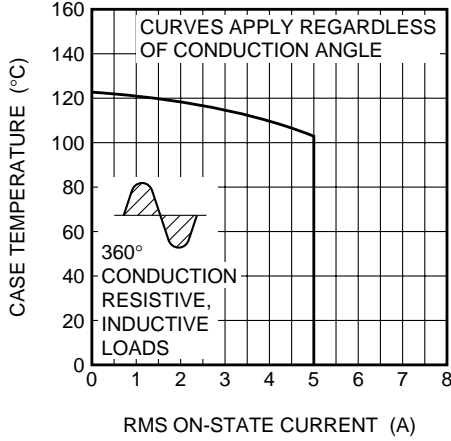

**ALLOWABLE AMBIENT TEMPERATURE VS. RMS ON-STATE CURRENT**

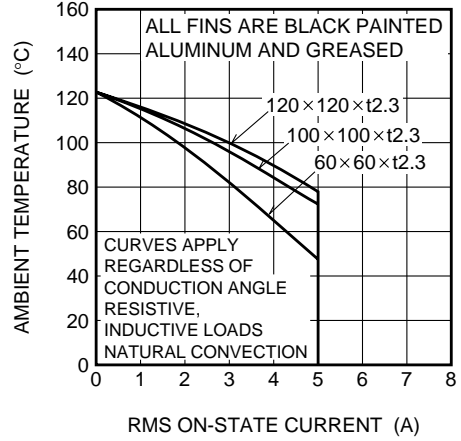

**ALLOWABLE AMBIENT TEMPERATURE VS. RMS ON-STATE CURRENT**

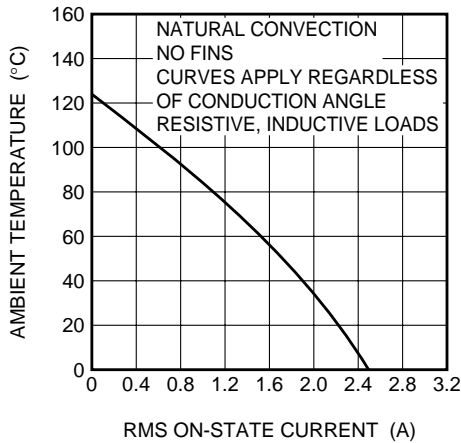

**REPETITIVE PEAK OFF-STATE CURRENT VS. JUNCTION TEMPERATURE**

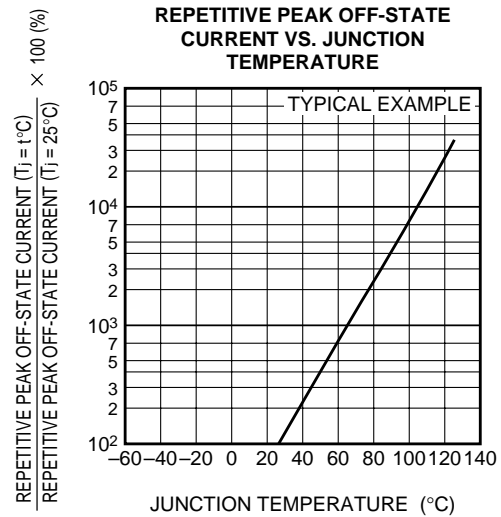

**HOLDING CURRENT VS. JUNCTION TEMPERATURE**

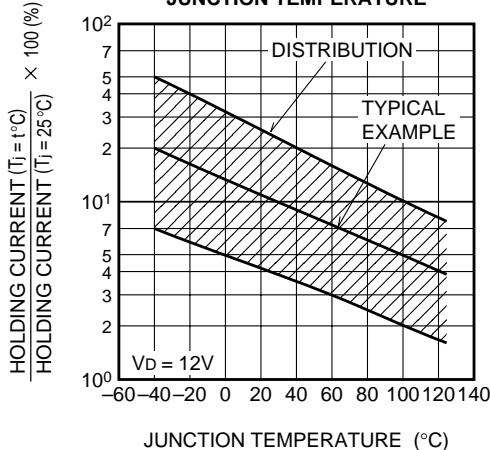

**LACHING CURRENT VS. JUNCTION TEMPERATURE**

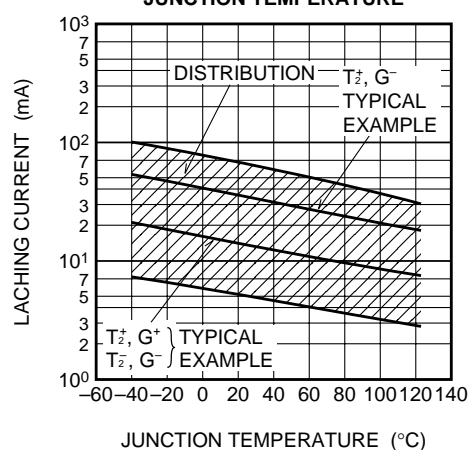

# BCR5KM

MEDIUM POWER USE  
INSULATED TYPE, PLANAR PASSIVATION TYPE

**BREAKOVER VOLTAGE VS. JUNCTION TEMPERATURE**

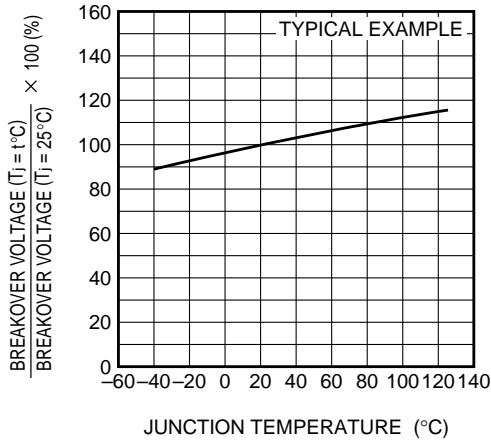

**BREAKOVER VOLTAGE VS. RATE OF RISE OF OFF-STATE VOLTAGE**

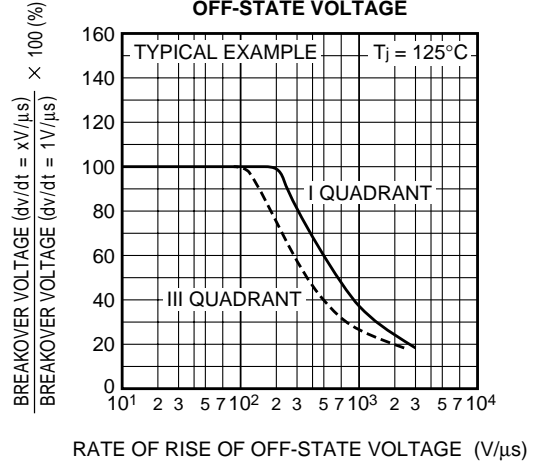

**GATE TRIGGER CURRENT VS. GATE CURRENT PULSE WIDTH**

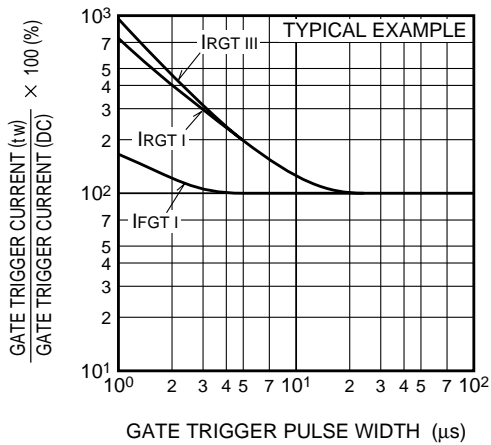

**GATE TRIGGER CHARACTERISTICS TEST CIRCUITS**

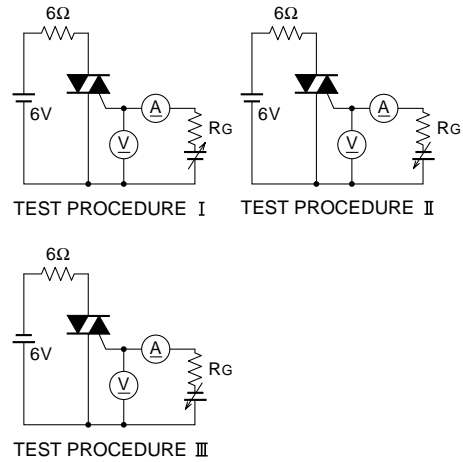

This datasheet has been download from:

[www.datasheetcatalog.com](http://www.datasheetcatalog.com)

Datasheets for electronics components.