

Features

1. Normally Open, Single Pole Single Throw
2. Control 350VAC or DC Voltage
3. Switch 130mA Loads
4. LED control Current, 5mA
5. Low ON-Resistance
6. dv/dt, >500V/ms
7. Isolation Test Voltage, 1500VACrms

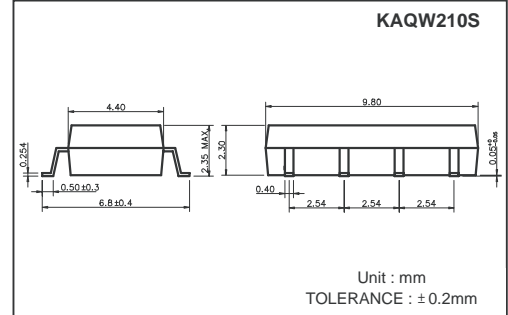

Absolute Maximum Ratings

(Ta=25°C)

Emitter (Input)	Detector (Output)
Reverse Voltage.....5.0V	Output Breakdown Voltage±350V
Continuous Forward Current50mA	Continuous Load Current±130mA
Peak Forward Current1A	Power Dissipation500mW
Power Dissipation100mW	
Derate Linearly from 25°C1.3mW/°C	
General Characteristics	
Isolation Test Voltage.....1500VACrms	Storage Temperature Range ...-40°C to +125°C
Isolation Resistance	Operating Temperature Range...-30°C to +85°C
Vio=500V, Ta=25°C≥10 ¹⁰ Ω	Junction Temperature.....100°C
Total Power Dissipation550mW	Soldering Temperature,
Derate Linearly from 25°C2.5mW/°C	2mm from case, 10 sec260°C

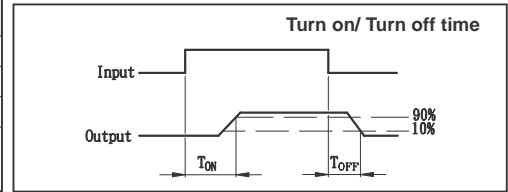

Electro-optical Characteristics

(Ta=25°C)

Parameter	Symbol	Conditions	Min.	Typ.	Max.	Unit
Emitter (Input)						
Forward Voltage	V _F	I _F =10mA		1.2	1.5	V
Operation Input Current	I _{FON}	V _L =±20V, I _L =100mA, t =10mS			5	mA
Recovery Input Current	I _{FOFF}	V _L =±20V, I _L ≤5uA	0.2			mA
Detector (Output)						
Output Breakdown Voltage	V _B	I _B =50uA	350			V
Output Off-State Leakage	I _{TOFF}	V _T =100V, I _F =0mA		0.2	1	uA
I/O Capacitance	C _{ISO}	I _F =0, f =1MHz		6		pF
ON Resistance	R _{ON}	I _L =100mA, I _F =10mA		20	25	Ω
Reverse (ON) Time	T _{ON}	I _F =10mA, V _L =±20V		0.3	1.0	ms
Operate (OFF) Time	T _{OFF}		t =10ms, I _L =±100mA		0.7	1.5

Schematic and Wiring Diagrams

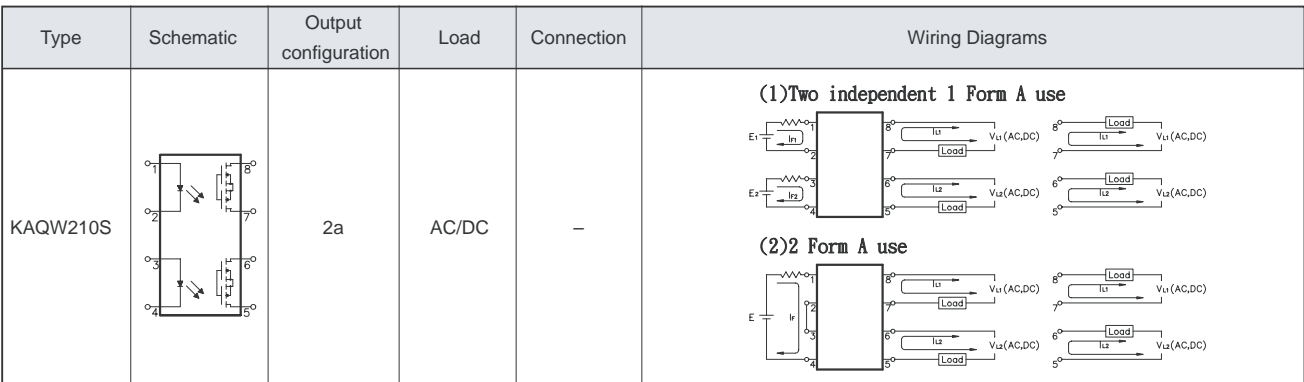

Data Curve

Fig.1 Load current vs. ambient temperature
Allowable ambient temperature:
-40°C to +85°C

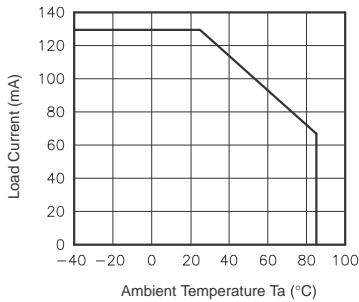

Fig.2 On resistance vs. ambient temperature
Across terminals 5,7 and 6,8 pin
LED current: 5mA
Continuous load current: 130mA(DC)

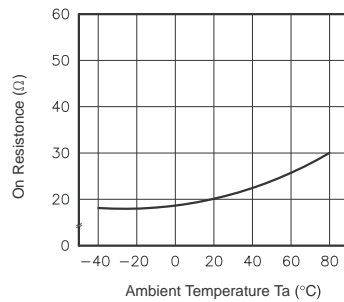

Fig.3 Turn on time vs. ambient temperature
Load voltage 350V(DC)
LED current: 5mA
Continuous load current: 130mA(DC)

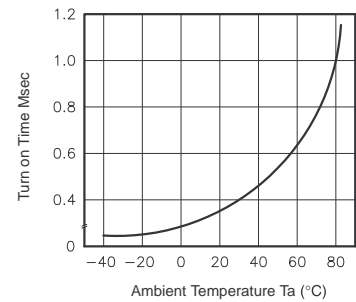

Fig.4 Turn off time vs. ambient temperature
LED current: 5mA; Load voltage:
350V(DC)
Continuous load current: 130mA(DC)

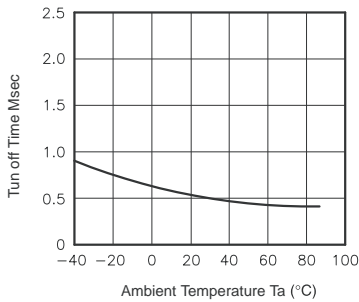

Fig.5 LED operate vs. ambient temperature
Load voltage 350V(DC)
Continuous load current: 130mA(DC)

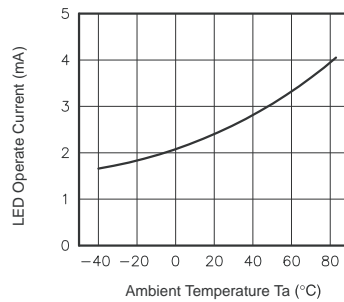

Fig.6 LED turn off current vs. ambient temperature
Load voltage 350V(DC)
Continuous load current: 130mA(DC)

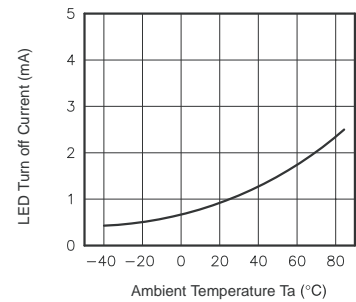

Fig.7 LED dropout voltage vs. ambient temperature
LED current: 5 to 50mA

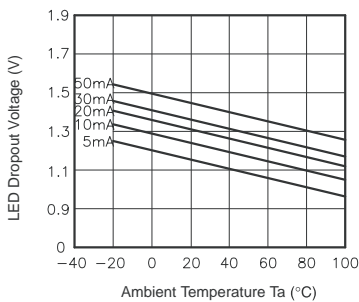

Fig.8 Voltage vs. current characteristics of output at MOS FET portion
Measured portion: across terminals 5,7 and 6,8 pin
Ambient temperature: 25°C

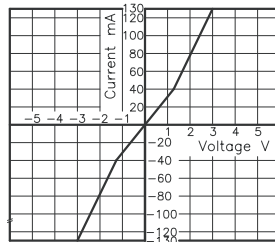

Fig.9 Off state leakage current
Across terminals 5,7 and 6,8 pin
Ambient temperature: 25°C

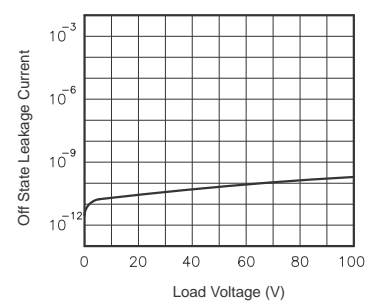

Fig.10 LED forward current vs. turn on time
Across terminals 5,7 and 6,8 pin;
Load voltage: 350V (DC);
Continuous load current: 130mA (DC);
Ambient temperature: 25°C

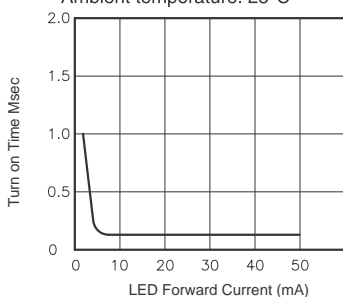

Fig.11 LED forward current vs. turn off time
Across terminals 5,7 and 6,8 pin;
Load voltage: 350V (DC);
Continuous load current: 130mA (DC);
Ambient temperature: 25°C

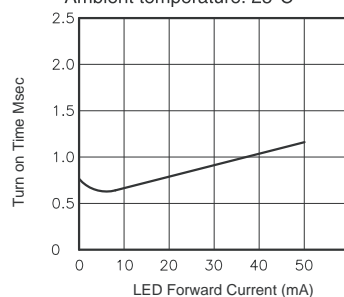
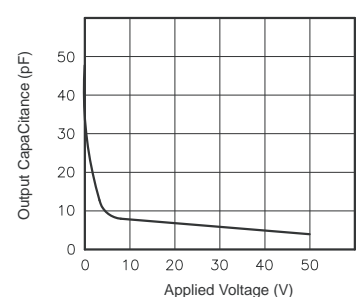

Fig.12 Applied voltage vs. output capacitance
Across terminals 5,7 and 6,8 pin
Frequency: 1MHz
Ambient temperature: 25°C



This datasheet has been download from:

www.datasheetcatalog.com

Datasheets for electronics components.