

MM3Z2B4~MM3ZB75

Silicon Planar Zener Diodes

Features

- Power Dissipation: 300 mW
- Zener Voltage Tolerance: $\pm 2\%$

PINNING

PIN	DESCRIPTION
1	Cathode
2	Anode

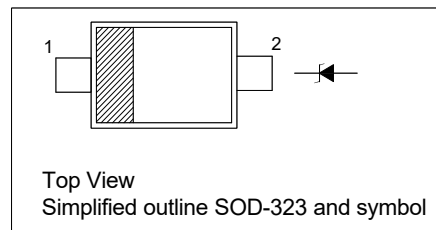

Absolute Maximum Ratings ($T_a = 25\text{ }^\circ\text{C}$)

Parameter	Symbol	Value	Unit
Total Power Dissipation	P_{tot}	300	mW
Junction Temperature	T_j	150	$^\circ\text{C}$
Storage Temperature Range	T_{stg}	- 55 to + 150	$^\circ\text{C}$

Characteristics at $T_a = 25\text{ }^\circ\text{C}$

Parameter	Symbol	Max.	Unit
Thermal Resistance Junction to Ambient Air	$R_{\theta JA}$	417	$^\circ\text{C}/\text{W}$
Forward Voltage at $I_F = 10\text{ mA}$	V_F	0.9	V

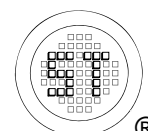

MM3Z2B4~MM3ZB75

Characteristics at $T_a = 25^\circ\text{C}$

Type	Marking Code	Zener Voltage Range ¹⁾			Dynamic Impedance		Reverse Leakage Current	
		V_{znom}	V_{ZT}	at I_{zT}	Z_{zT}	at I_{zT}	I_R	at V_R
		(V)	(V)	(mA)	Max. (Ω)	(mA)	Max. (μA)	(V)
MM3Z2B4	DN	2.4	2.352...2.448	5	100	5	120	1
MM3Z2B7	DP	2.7	2.646...2.754	5	110	5	120	1
MM3Z3B0	DR	3.0	2.94...3.06	5	120	5	50	1
MM3Z3B3	DX	3.3	3.234...3.366	5	130	5	20	1
MM3Z3B6	DY	3.6	3.528...3.672	5	130	5	10	1
MM3Z3B9	DZ	3.9	3.822...3.978	5	130	5	5	1
MM3Z4B3	Z0	4.3	4.214...4.386	5	130	5	5	1
MM3Z4B7	EB	4.7	4.606...4.794	5	130	5	2	1
MM3Z5B1	EC	5.1	4.998...5.202	5	130	5	2	1.5
MM3Z5B6	ED	5.6	5.488...5.712	5	80	5	1	2.5
MM3Z6B2	EE	6.2	6.076...6.324	5	50	5	1	3
MM3Z6B8	EF	6.8	6.664...6.936	5	30	5	0.5	3.5
MM3Z7B5	EH	7.5	7.35...7.65	5	30	5	0.5	4
MM3Z8B2	EJ	8.2	8.036...8.364	5	30	5	0.5	5
MM3Z9B1	EK	9.1	8.918...9.282	5	30	5	0.5	6
MM3ZB10	EM	10	9.8...10.2	5	30	5	0.1	7
MM3ZB11	EN	11	10.78...11.22	5	30	5	0.1	8
MM3ZB12	EP	12	11.76...12.24	5	35	5	0.1	9
MM3ZB13	ER	13	12.74...13.26	5	35	5	0.1	10
MM3ZB15	EX	15	14.7...15.3	5	40	5	0.1	11
MM3ZB16	EY	16	15.68...16.32	5	40	5	0.1	12
MM3ZB18	EZ	18	17.64...18.36	5	45	5	0.1	13
MM3ZB20	FA	20	19.6...20.4	5	50	5	0.1	15
MM3ZB22	FB	22	21.56...22.44	5	55	5	0.1	17
MM3ZB24	FC	24	23.52...24.48	5	60	5	0.1	19
MM3ZB27	FD	27	26.46...27.54	2	70	2	0.1	21
MM3ZB30	FE	30	29.4...30.6	2	80	2	0.1	23
MM3ZB33	FF	33	32.34...33.66	2	80	2	0.1	25
MM3ZB36	FH	36	35.28...36.72	2	90	2	0.1	27
MM3ZB39	FJ	39	38.22...39.78	2	100	2	0.1	30
MM3ZB43	XJ	43	42.14...43.86	2	130	2	0.1	33
MM3ZB47	XK	47	46.06...47.94	2	150	2	0.1	36
MM3ZB51	XM	51	49.98...52.02	2	180	2	0.1	39
MM3ZB56	XN	56	54.88...57.12	2	200	2	0.1	43
MM3ZB62	XP	62	60.76...63.24	2	215	2	0.1	47
MM3ZB68	XR	68	66.64...69.36	2	240	2	0.1	52
MM3ZB75	XX	75	73.5...76.5	2	265	2	0.1	56

¹⁾ V_{ZT} is tested with pulses (20 ms).

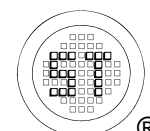

MM3Z2B4~MM3ZB75

Electrical characteristic curve

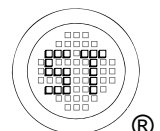
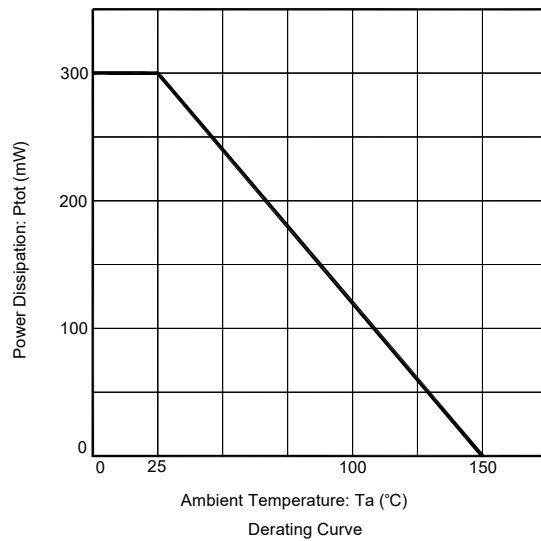
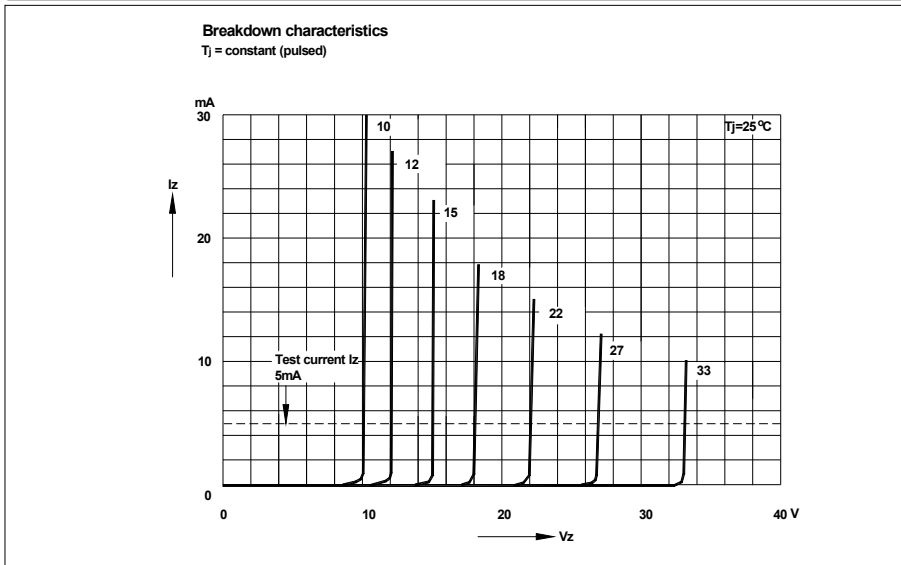
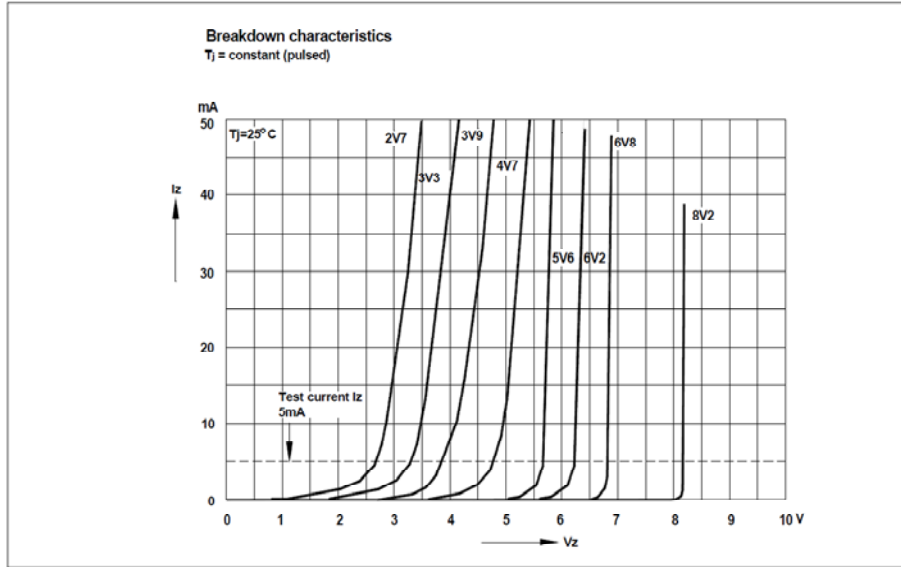

MM3Z2B4~MM3ZB75

PACKAGE OUTLINE

Plastic surface mounted package; 2 leads

SOD-323

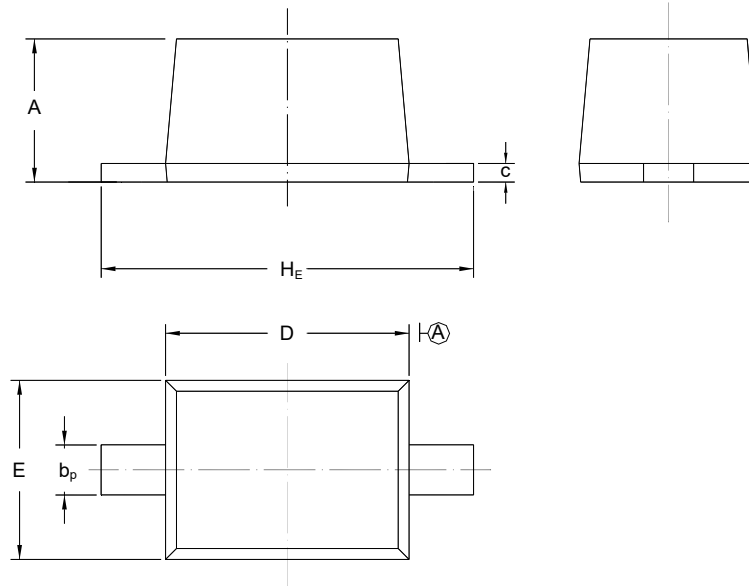

UNIT	A	b _p	C	D	E	H _E
mm	1.10 0.80	0.40 0.25	0.15 0.10	1.80 1.60	1.35 1.15	2.80 2.30

Recommended Soldering Footprint

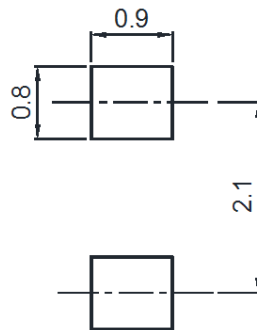

Packing information

Package	Tape Width (mm)	Pitch		Reel Size		Per Reel Packing Quantity
		mm	inch	mm	inch	
SOD-323	8	4 ± 0.1	0.157 ± 0.004	178	7	3,000

Marking information

" III " = Cathode line

" ** " = Part No.

Font type: Arial

