

SBD Type : FRH20A15

OUTLINE DRAWING

FEATURES

- *Similar to TO-220AB Case
- *Fully Molded Isolation
- *Dual Diodes – Anode Common
- *High Voltage Low Leakage Current
- *Low Forward Voltage Drop
- *Low Power Loss,High Efficiency
- *High Surge Capability
- *T_j=150 °C operation

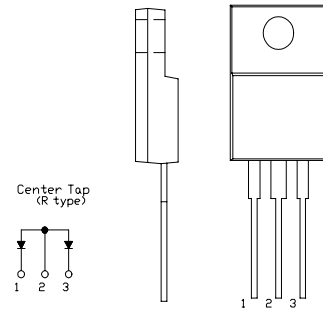

Maximum Ratings

Approx Net Weight: 1.75g

Rating	Symbol	FRH20A15			Unit
Repetitive Peak Reverse Voltage	V _{RRM}	150			V
Average Rectified Output Current	I _O	20	T _c =120°C	50 Hz Full Sine Wave Resistive Load	A
RMS Forward Current	I _{F(RMS)}	22.2			A
Surge Forward Current	I _{FSM}	180	50Hz Full Sine Wave ,1cycle Non-repetitive		A
Operating JunctionTemperature Range	T _{jw}	-40 to +150			°C
Storage Temperature Range	T _{stg}	-40 to +150			°C
Mounting torque	F _{tor}	recommended torque = 0.5			N•m

Electrical • Thermal Characteristics

Characteristics	Symbol	Conditions	Min.	Typ.	Max.	Unit
Peak Reverse Current	I _{RM}	T _j = 25°C, V _{RM} = V _{RRM} per Arm	-	-	1	mA
Peak Forward Voltage	V _{FM}	T _j = 25°C, I _{FM} = 10 A per Arm	-	-	0.90	V
Thermal Resistance	R _{th(j-c)}	Junction to Case	-	-	1.5	°C /W
	R _{th(c-f)}	Cace to Fin	-	-	1.5	°C /W

FRH20A15 OUTLINE DRAWING (Dimensions in mm)

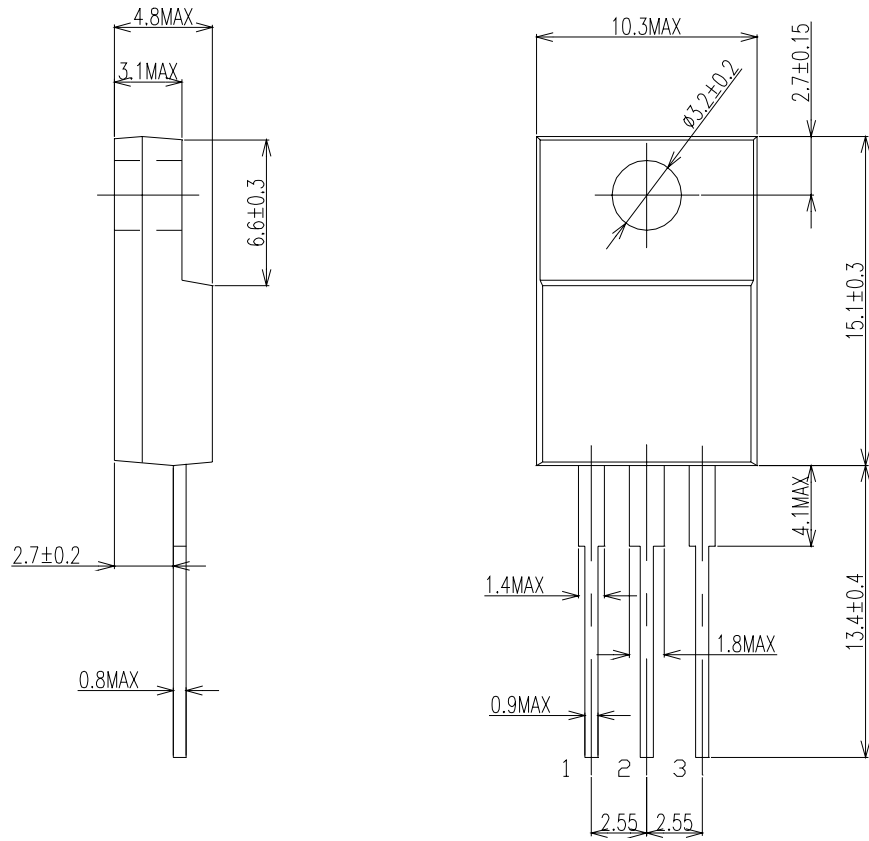

Center Tap
(R type)

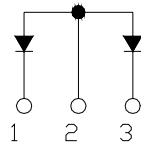

FORWARD CURRENT VS. VOLTAGE

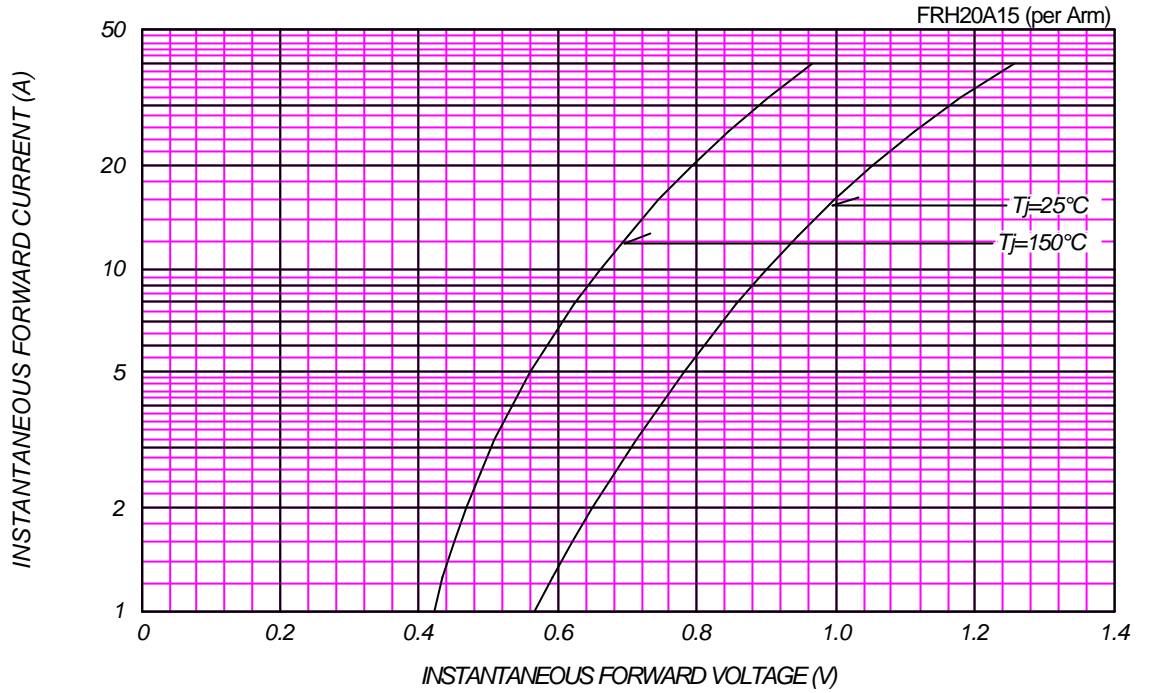

AVERAGE FORWARD POWER DISSIPATION

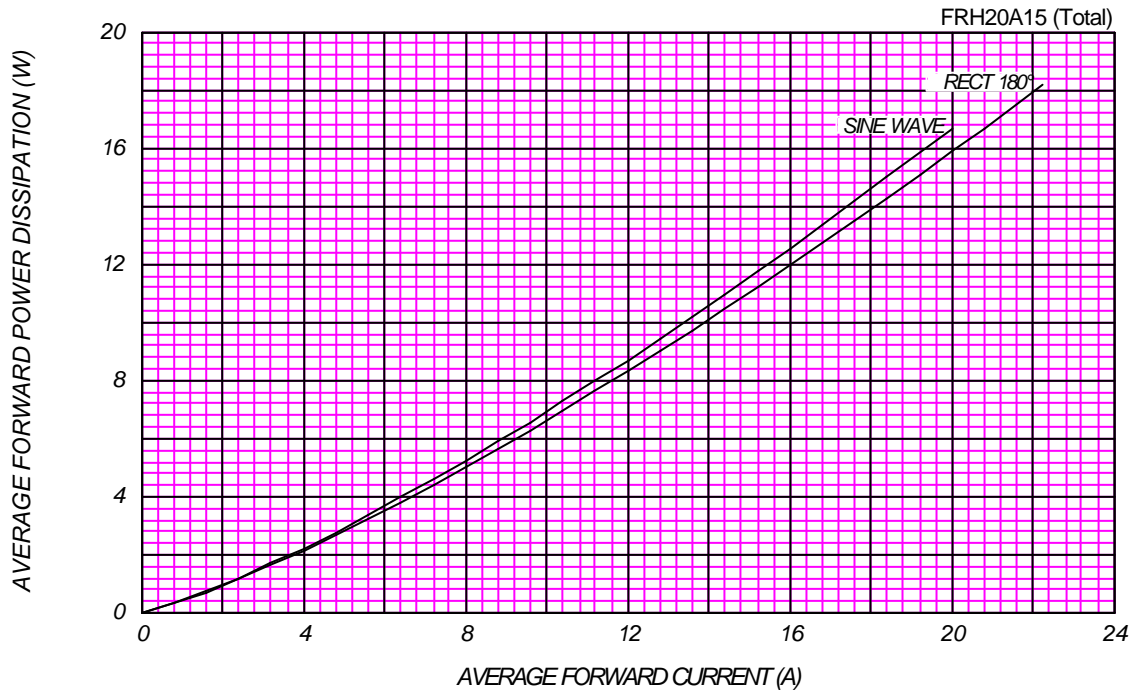

PEAK REVERSE CURRENT VS. PEAK REVERSE VOLTAGE

$T_j = 150\text{ }^\circ\text{C}$

FRH20A15 (per Arm)

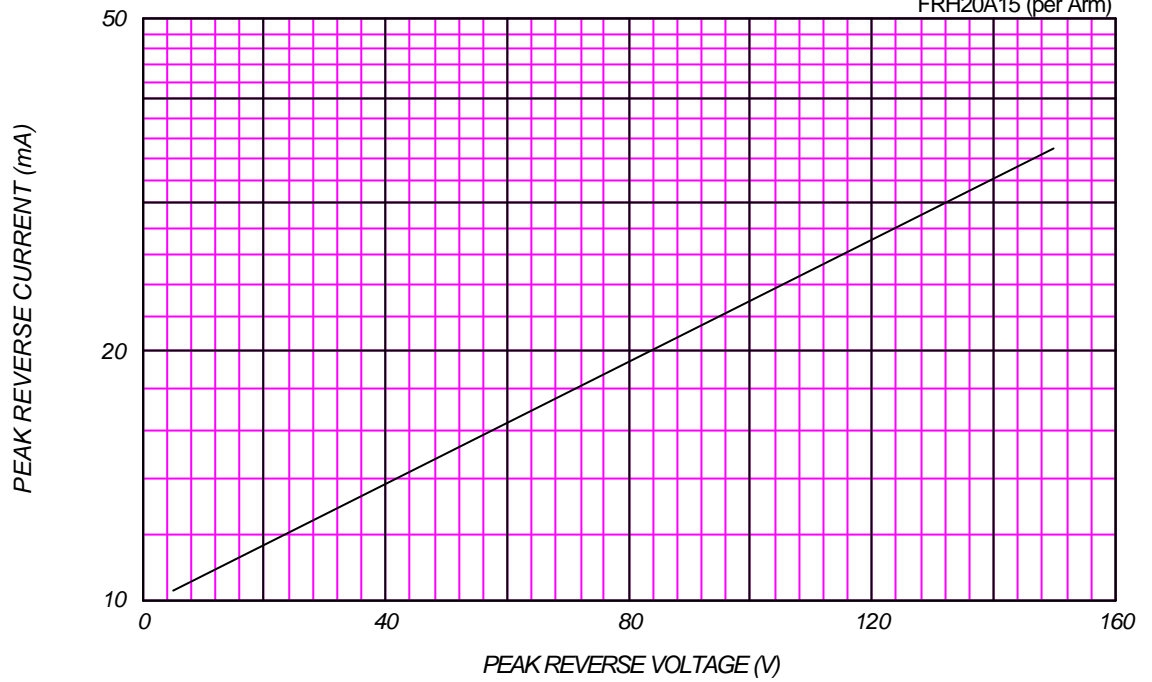

AVERAGE REVERSE POWER DISSIPATION

FRH20A15 (Total)

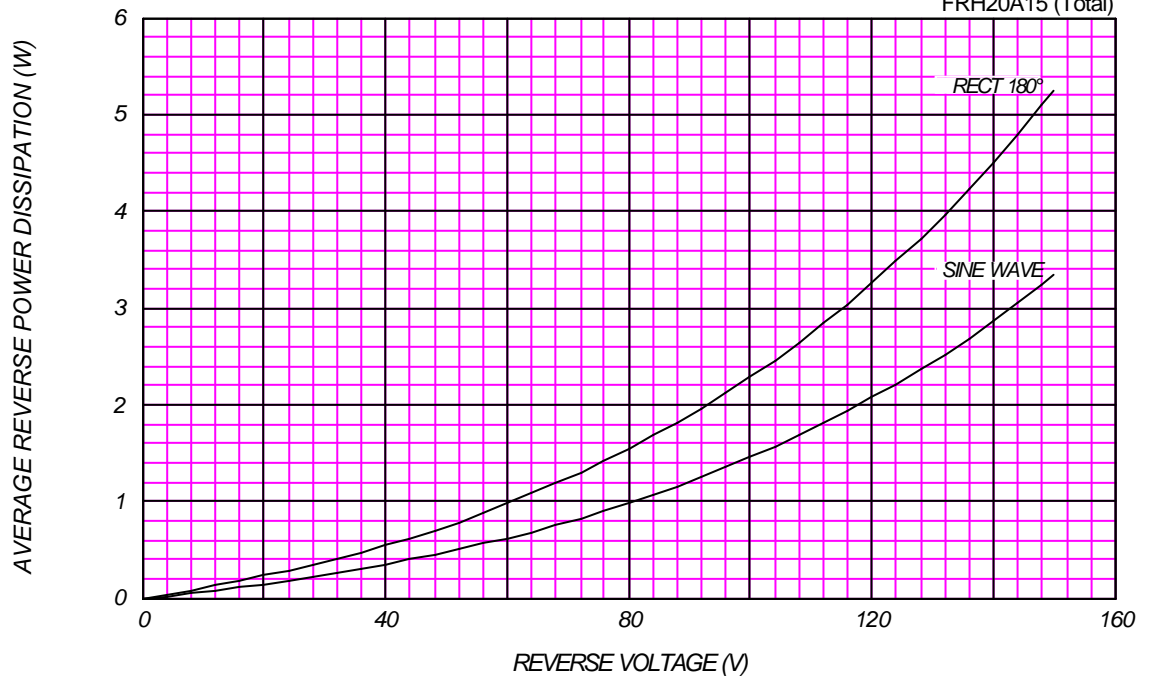



AVERAGE FORWARD CURRENT VS. CASE TEMPERATURE

$V_{RM} = 150V$

FRH20A15 (Total)

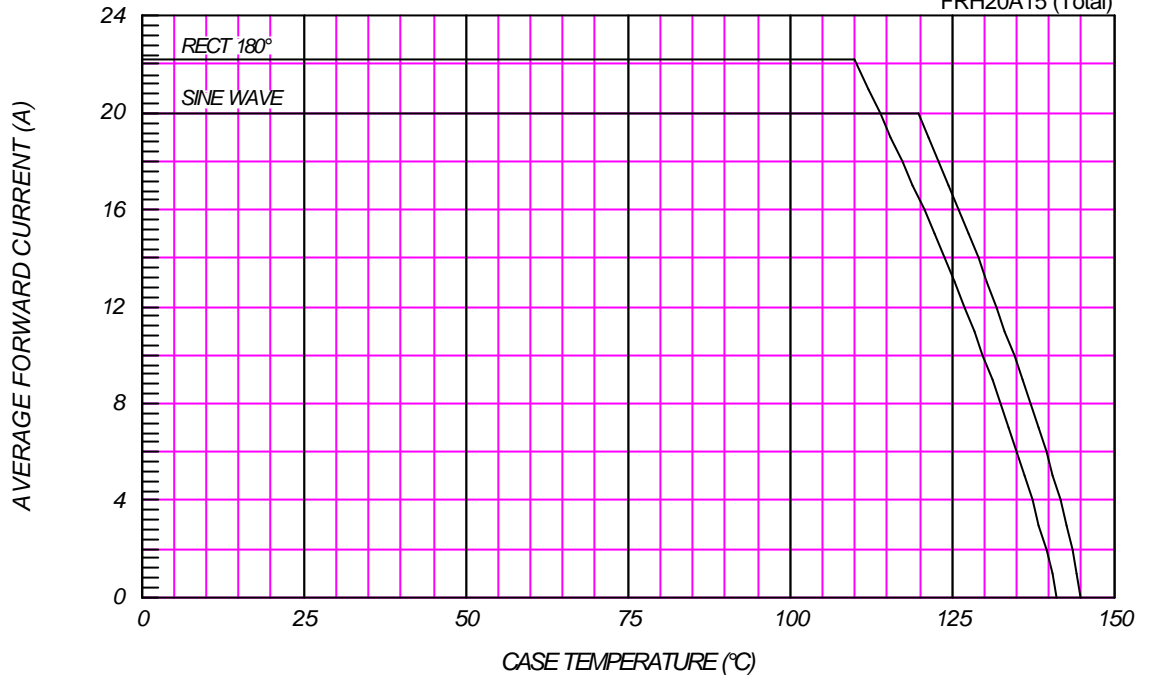

SURGE CURRENT RATINGS

f=50Hz, Sine Wave, Non-Repetitive, No Load

FRH20A15

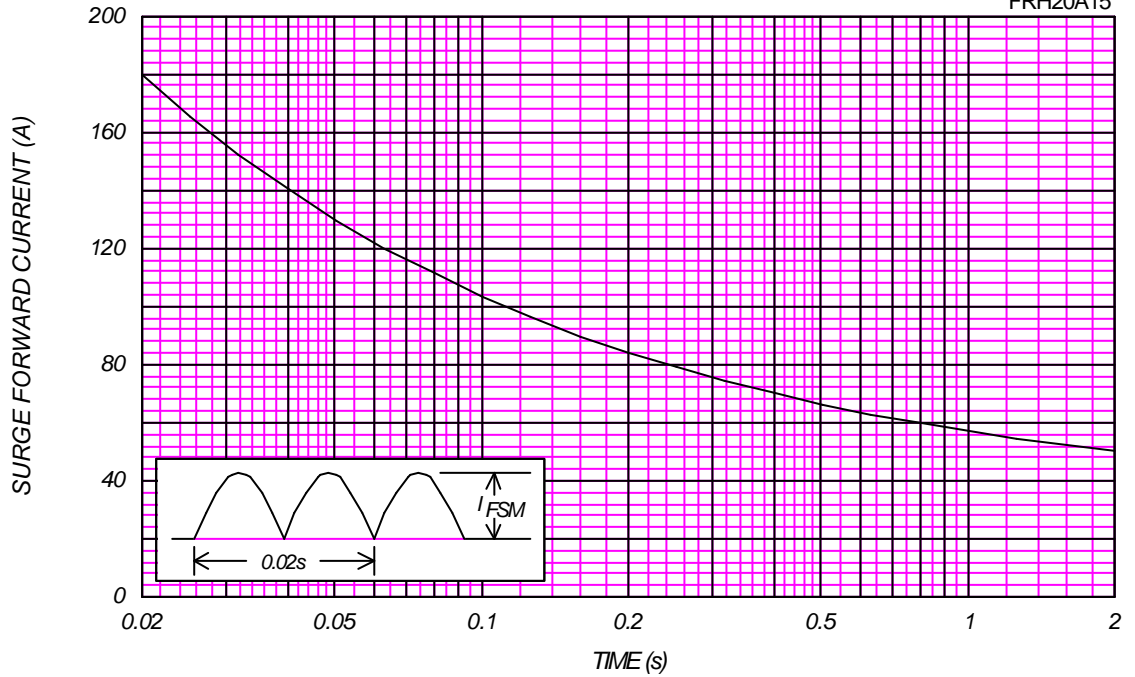

JUNCTION CAPACITANCE VS. REVERSE VOLTAGE

$T_j=25^\circ\text{C}$, $V_m=20\text{mV}_{\text{RMS}}$, $f=100\text{kHz}$, Typical Value

FRH20A15 (per Arm)

