

# SKFM1020C-D THRU SKFM10200C-D

## List

List..... 1

Package outline..... 2

Features..... 2

Mechanical data..... 2

Maximum ratings and Electrical characteristics .....2

Rating and characteristic curves..... 3

Pinning information.....4

Marking..... 4

Suggested solder pad layout..... 4

Packing information..... 5

Reel packing..... 6

Suggested thermal profiles for soldering processes..... 6

High reliability test capabilities.....7

# SKFM1020C-D THRU SKFM10200C-D

## 10.0A Surface Mount Schottky Barrier Rectifiers-20V-200V

### Features

- Low power loss, high efficiency.
- High current capability, low forward voltage drop.
- High surge capability.
- Guardring for overvoltage protection.
- Ultra high-speed switching.
- Silicon epitaxial planar chip, metal silicon junction.
- Lead-free parts meet environmental standards of MIL-STD-19500 /228
- Suffix "-H" for Halogen-free part, ex. SKFM1020C-D-H.

### Mechanical data

- Epoxy: UL94-V0 rated flame retardant
- Case : Molded plastic, TO-252 / DPAK
- Terminals : Solder plated, solderable per MIL-STD-750, Method 2026
- Mounting Position : Any
- Weight : Approximated 0.34 gram

### Package outline

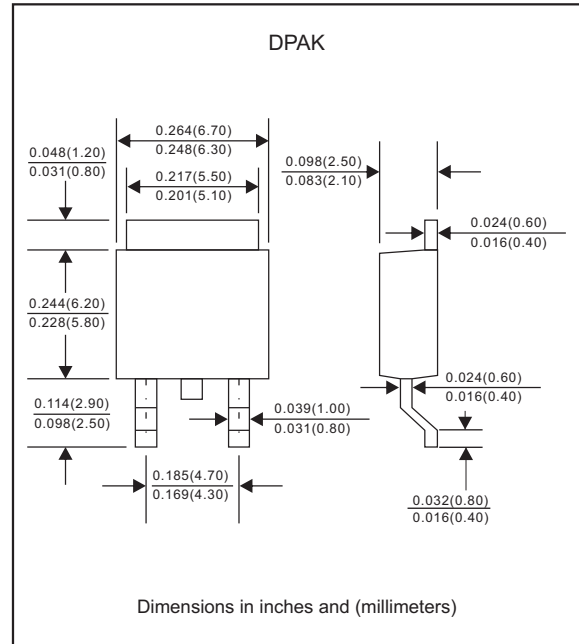

### Maximum ratings and Electrical characteristics (AT $T_A=25^{\circ}\text{C}$ unless otherwise noted)

PARAMETER	CONDITIONS	Symbol	MIN.	TYP.	MAX.	UNIT
Forward rectified current	See Fig.1	$I_o$			10.0	A
Forward surge current	8.3ms single half sine-wave (JEDEC methode)	$I_{FSM}$			100	A
Reverse current	$V_R = V_{RRM}$ $T_J = 25^{\circ}\text{C}$	$I_R$			0.5	mA
	$V_R = V_{RRM}$ $T_J = 100^{\circ}\text{C}$				20	
Typical thermal resistance	Junction to ambient	$R_{\theta JA}$		38		$^{\circ}\text{C}/\text{W}$
	Junction to case	$R_{\theta JC}$		21		$^{\circ}\text{C}/\text{W}$
Diode junction capacitance	f=1MHz and applied 4V DC reverse voltage	$C_j$		380		pF
Storage temperature		$T_{STG}$	-65		+175	$^{\circ}\text{C}$

SYMBOLS	$V_{RRM}^{*1}$ (V)	$V_{RMS}^{*2}$ (V)	$V_R^{*3}$ (V)	$V_F^{*4}$ (V)	Operating temperature $T_J$ , ( $^{\circ}\text{C}$ )
SKFM1020C-D	20	14	20	0.55	-55 to +125
SKFM1030C-D	30	21	30		
SKFM1040C-D	40	28	40		
SKFM1045C-D	45	31.5	45		
SKFM1050C-D	50	35	50	0.70	-55 to +150
SKFM1060C-D	60	42	60		
SKFM1080C-D	80	56	80		
SKFM10100C-D	100	70	100		
SKFM10150C-D	150	105	150	0.85	
SKFM10200C-D	200	140	200		

- \*1 Repetitive peak reverse voltage
- \*2 RMS voltage
- \*3 Continuous reverse voltage
- \*4 Maximum forward voltage@ $I_F = 5.0\text{A}$

# Rating and characteristic curves (SKFM1020C-D THRU SKFM10200C-D)

FIG.1-TYPICAL FORWARD CURRENT DERATING CURVE

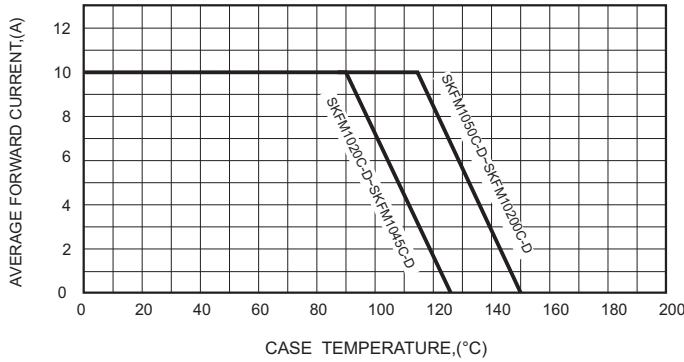

FIG.2-TYPICAL FORWARD CHARACTERISTICS

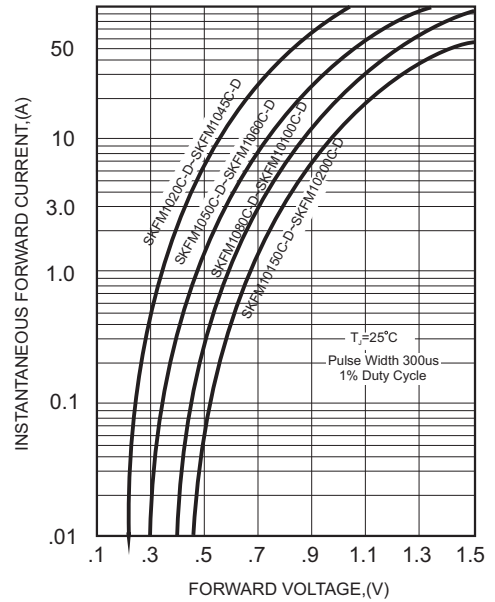

FIG.3-MAXIMUM NON-REPETITIVE FORWARD SURGE CURRENT

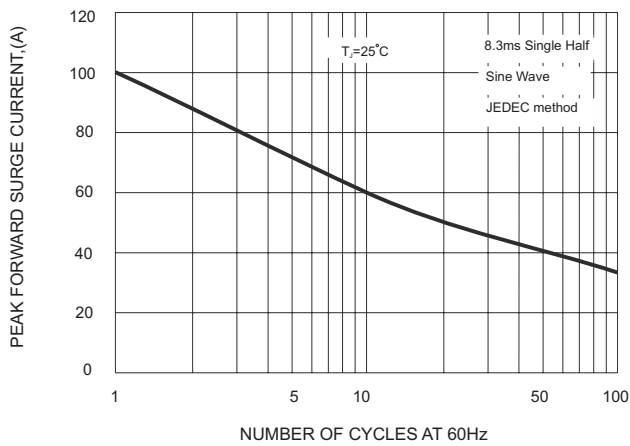

FIG.4 - TYPICAL REVERSE CHARACTERISTICS

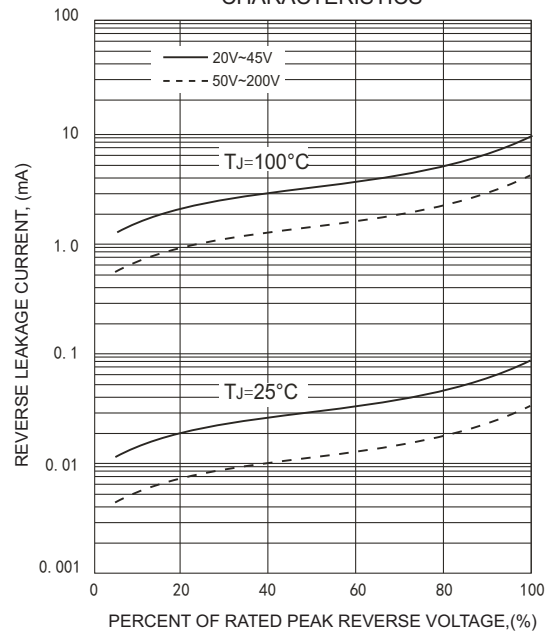
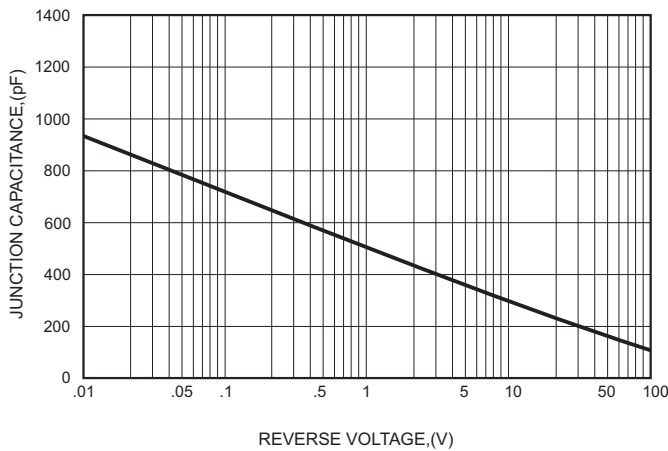
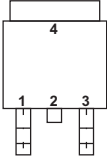
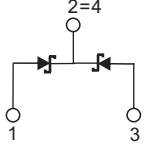

FIG.5-TYPICAL JUNCTION CAPACITANCE



# SKFM1020C-D THRU SKFM10200C-D

## Pinning information

Simplified outline	Symbol
	

## Marking

Type number	Marking code
SKFM1020C-D	SK1020
SKFM1030C-D	SK1030
SKFM1040C-D	SK1040
SKFM1045C-D	SK1040
SKFM1050C-D	SK1050
SKFM1060C-D	SK1060
SKFM1080C-D	SK1080
SKFM10100C-D	SK10100
SKFM10150C-D	SK10150
SKFM10200C-D	SK10200

## Suggested solder pad layout

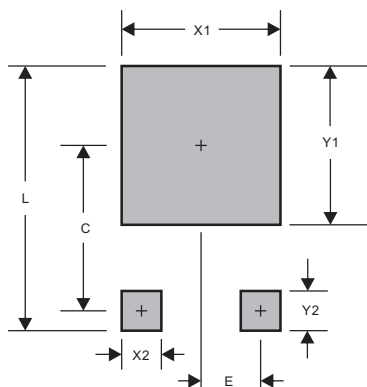

PACKAGE	DPAK
C	0.272(6.90)
E	0.091(2.30)
L	0.457(11.60)
X1	0.276(7.00)
X2	0.059(1.50)
Y1	0.276(7.00)
Y2	0.098(2.50)

Dimensions in inches and (millimeters)

# SKFM1020C-D THRU SKFM10200C-D

## Packing information

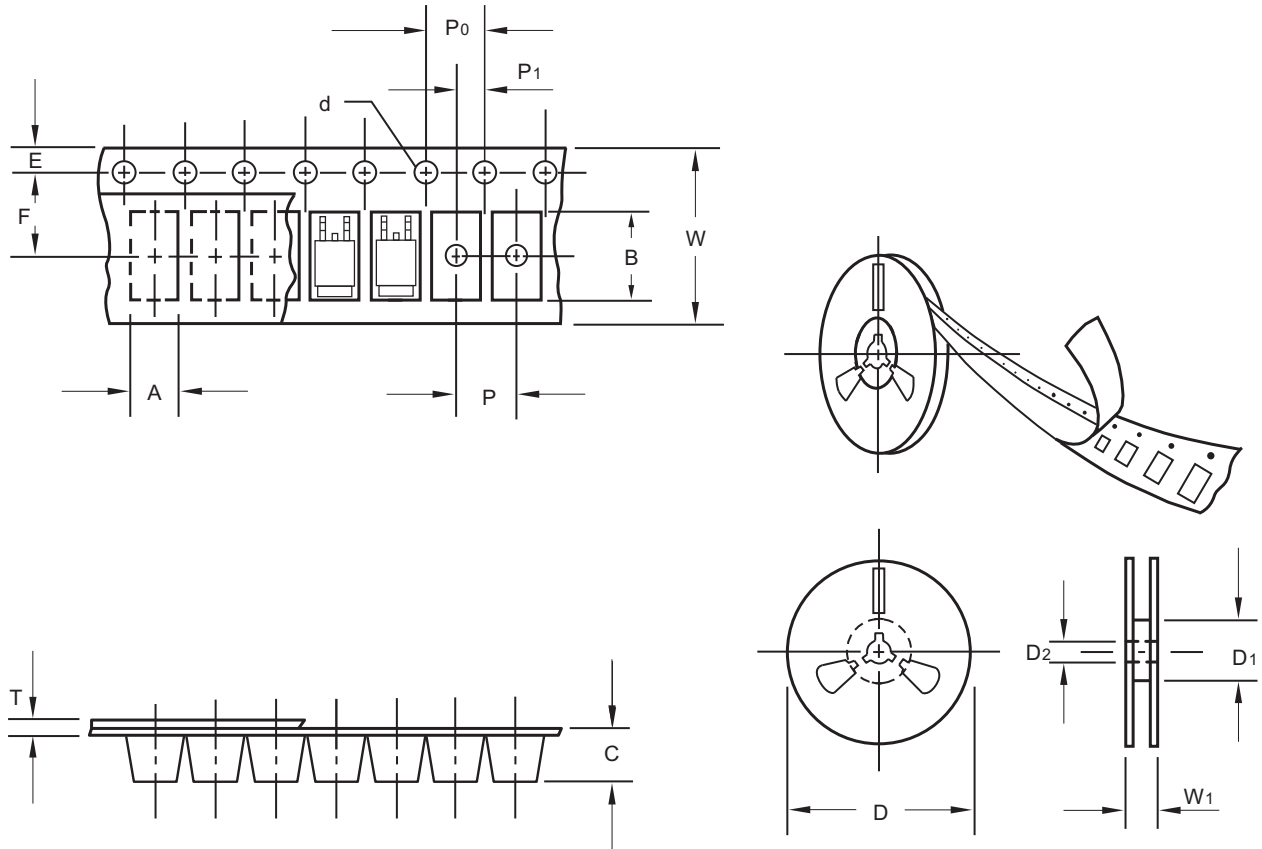

unit:mm

Item	Symbol	Tolerance	DPAK
Carrier width	A	0.1	6.90
Carrier length	B	0.1	10.50
Carrier depth	C	0.1	2.70
Sprocket hole	d	0.1	1.50
13" Reel outside diameter	D	2.0	330.00
13" Reel inner diameter	D1	min	50.00
7" Reel outside diameter	D	2.0	-
7" Reel inner diameter	D1	min	-
Feed hole diameter	D2	0.5	13.00
Sprocket hole position	E	0.1	1.75
Punch hole position	F	0.1	7.50
Punch hole pitch	P	0.1	8.00
Sprocket hole pitch	P0	0.1	4.00
Embossment center	P1	0.1	2.00
Overall tape thickness	T	0.1	0.23
Tape width	W	0.3	16.00
Reel width	W1	1.0	22.00

Note: Devices are packed in accordance with EIA standard RS-481-A and specifications listed above.

# SKFM1020C-D THRU SKFM10200C-D

## Reel packing

PACKAGE	REEL SIZE	REEL (pcs)	COMPONENT SPACING (m/m)	BOX (pcs)	INNER BOX (m/m)	REEL DIA, (m/m)	CARTON SIZE (m/m)	CARTON (pcs)	APPROX. GROSS WEIGHT (kg)
TO-252 / DPAK	13"	3,000	8.0	6,000	335*335*38	330	350*350*225	30,000	15.5

## Suggested thermal profiles for soldering processes

- 1.Storage environment: Temperature=5°C~40°C Humidity=55%±25%
- 2.Reflow soldering of surface-mount devices

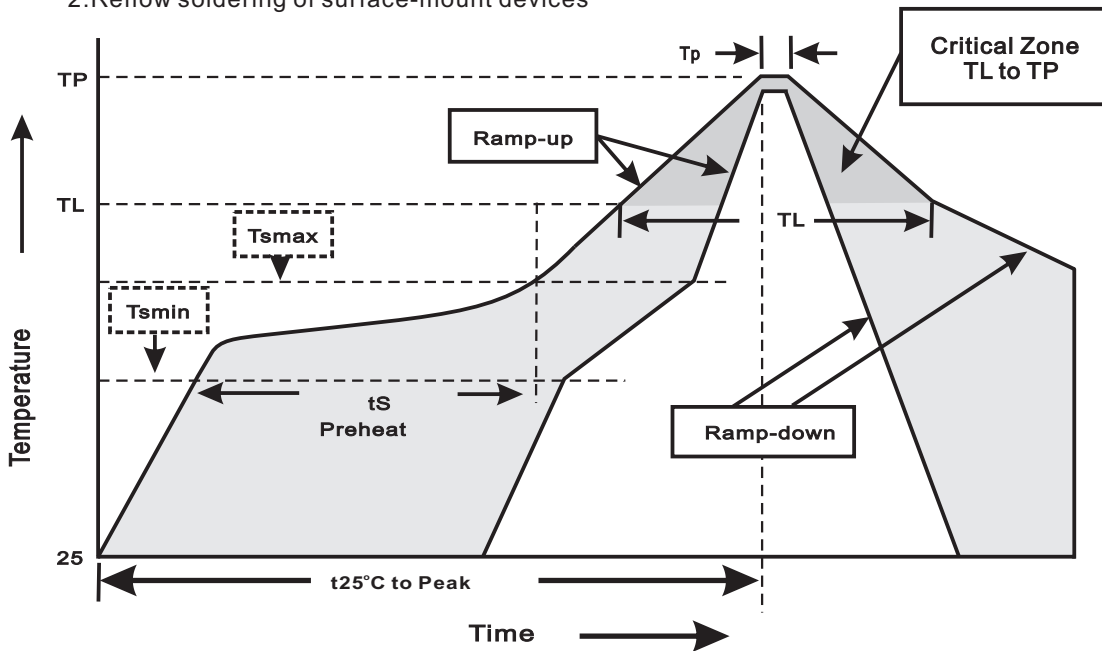

### 3.Reflow soldering

Profile Feature	Soldering Condition
Average ramp-up rate(T <sub>L</sub> to T <sub>P</sub> )	<3°C/sec
Preheat -Temperature Min(T <sub>smin</sub> ) -Temperature Max(T <sub>smax</sub> ) -Time(min to max)(t <sub>s</sub> )	150°C 200°C 60~120sec
T <sub>smax</sub> to T <sub>L</sub> -Ramp-upRate	<3°C/sec
Time maintained above: -Temperature(T <sub>L</sub> ) -Time(t <sub>L</sub> )	217°C 60~260sec
Peak Temperature(T <sub>P</sub> )	255°C-0/+5°C
Time within 5°C of actual Peak Temperature(t <sub>P</sub> )	10~30sec
Ramp-down Rate	<3°C/sec
Time 25°C to Peak Temperature	<6minutes

**SKFM1020C-D THRU SKFM10200C-D****High reliability test capabilities**

Item Test	Conditions	Reference
1. Solder Resistance	at 260±5°C for 10±2sec.	MIL-STD-750D METHOD-2031
2. Solderability	at 245±5°C for 5 sec.	MIL-STD-202F METHOD-208
3. High Temperature Reverse Bias	$V_R=80\%$ rate at $T_J=125^\circ\text{C}$ for 168 hrs.	MIL-STD-750D METHOD-1038
4. Forward Operation Life	Rated average rectifier current at $T_A=25^\circ\text{C}$ for 500hrs.	MIL-STD-750D METHOD-1027
5. Intermittent Operation Life	$T_A = 25^\circ\text{C}$ , $I_F = I_o$ On state: power on for 5 min. off state: power off for 5 min. on and off for 500 cycles.	MIL-STD-750D METHOD-1036
6. Pressure Cooker	15P <sub>SIG</sub> at $T_A=121^\circ\text{C}$ for 4 hrs.	JESD22-A102
7. Temperature Cycling	-55°C to +125°C dwelled for 30 min. and transferred for 5min. total 10 cycles.	MIL-STD-750D METHOD-1051
8. Forward Surge	8.3ms single half sine-wave , one surge.	MIL-STD-750D METHOD-4066-2
9. Humidity	at $T_A=85^\circ\text{C}$ , RH=85% for 1000hrs.	MIL-STD-750D METHOD-1021
10. High Temperature Storage Life	at 175°C for 1000 hrs.	MIL-STD-750D METHOD-1031