

Anti-Parallel  
APT2X30D60J

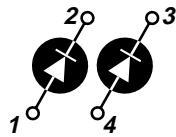

Parallel  
APT2X31D60J

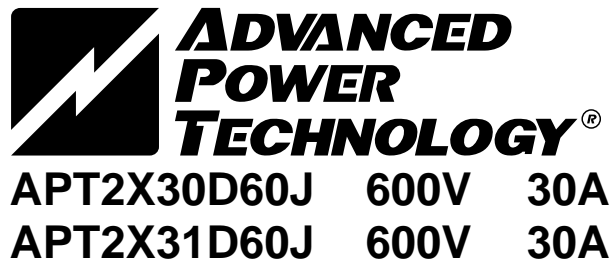
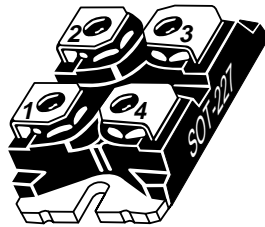

## DUAL DIE ISOTOP® PACKAGE

### ULTRAFAST SOFT RECOVERY DUAL RECTIFIER DIODES

PRODUCT APPLICATIONS	PRODUCT FEATURES	PRODUCT BENEFITS
<ul style="list-style-type: none"> <li>• Anti-Parallel Diode               <ul style="list-style-type: none"> <li>-Switchmode Power Supply</li> <li>-Inverters</li> </ul> </li> <li>• Free Wheeling Diode               <ul style="list-style-type: none"> <li>-Motor Controllers</li> <li>-Converters</li> </ul> </li> <li>• Snubber Diode</li> <li>• Uninterruptible Power Supply (UPS)</li> <li>• Induction Heating</li> <li>• High Speed Rectifiers</li> </ul>	<ul style="list-style-type: none"> <li>• Ultrafast Recovery Times</li> <li>• Soft Recovery Characteristics</li> <li>• Popular SOT-227 Package</li> <li>• Low Forward Voltage</li> <li>• High Blocking Voltage</li> <li>• Low Leakage Current</li> </ul>	<ul style="list-style-type: none"> <li>• Low Losses</li> <li>• Low Noise Switching</li> <li>• Cooler Operation</li> <li>• Higher Reliability Systems</li> <li>• Increased System Power Density</li> </ul>

#### MAXIMUM RATINGS

All Ratings:  $T_C = 25^\circ\text{C}$  unless otherwise specified.

Symbol	Characteristic / Test Conditions	APT2X30/2X31D60J	UNIT
$V_R$	Maximum D.C. Reverse Voltage	600	Volts
$V_{RRM}$	Maximum Peak Repetitive Reverse Voltage		
$V_{RWM}$	Maximum Working Peak Reverse Voltage		
$I_F(AV)$	Maximum Average Forward Current ( $T_C = 100^\circ\text{C}$ , Duty Cycle = 0.5)	30	Amps
$I_F(RMS)$	RMS Forward Current	70	
$I_{FSM}$	Non-Repetitive Forward Surge Current ( $T_J = 45^\circ\text{C}$ , 8.3ms)	320	
$T_J, T_{STG}$	Operating and Storage Temperature Range	-55 to 150	$^\circ\text{C}$
$T_L$	Lead Temperature: 0.063" from Case for 10 Sec.	300	

#### STATIC ELECTRICAL CHARACTERISTICS

Symbol	Characteristic / Test Conditions	MIN	TYP	MAX	UNIT
$V_F$	Maximum Forward Voltage			1.8	Volts
				$I_F = 30\text{A}$	
				$I_F = 60\text{A}$	
$I_{RM}$	Maximum Reverse Leakage Current			250	$\mu\text{A}$
				$V_R = V_R$ Rated	
$C_T$	Junction Capacitance, $V_R = 200\text{V}$		40		pF
$L_S$	Series Inductance (Lead to Lead 5mm from Base)		20		nH

APT Website - <http://www.advancedpower.com>

USA  
405 S.W. Columbia Street  
EUROPE

Avenue J.F. Kennedy Bât B4 Parc Cadéra Nord

Bend, Oregon 97702-1035

F-33700 Merignac - France

Phone: (541) 382-8028

Phone: (33) 5 57 92 15 15

FAX: (541) 388-0364

FAX: (33) 5 56 47 97 61

**DYNAMIC CHARACTERISTICS**

**APT2X30/2X31D60J**

Symbol	Characteristic	MIN	TYP	MAX	UNIT
$t_{rr1}$	Reverse Recovery Time, $I_F = 1.0A$ , $di_F/dt = -15A/\mu s$ , $V_R = 30V$ , $T_J = 25^\circ C$		50	65	ns
$t_{rr2}$	Reverse Recovery Time		50		
$t_{rr3}$	$I_F = 30A$ , $di_F/dt = -240A/\mu s$ , $V_R = 350V$		80		
$t_{fr1}$	Forward Recovery Time		155		
$t_{fr2}$	$I_F = 30A$ , $di_F/dt = 240A/\mu s$ , $V_R = 350V$		155		
$I_{RRM1}$	Reverse Recovery Current		4	10	Amps
$I_{RRM2}$	$I_F = 30A$ , $di_F/dt = -240A/\mu s$ , $V_R = 350V$		7.5	15	
$Q_{rr1}$	Recovery Charge		100		nC
$Q_{rr2}$	$I_F = 30A$ , $di_F/dt = -240A/\mu s$ , $V_R = 350V$		300		
$V_{fr1}$	Forward Recovery Voltage		5		Volts
$V_{fr2}$	$I_F = 30A$ , $di_F/dt = 240A/\mu s$ , $V_R = 350V$		5		
$diM/dt$	Rate of Fall of Recovery Current		400		A/ $\mu s$
	$I_F = 30A$ , $di_F/dt = -240A/\mu s$ , $V_R = 350V$ (See Figure 10)		200		

**THERMAL AND MECHANICAL CHARACTERISTICS**

Symbol	Characteristic / Test Conditions	MIN	TYP	MAX	UNIT
$R_{\theta JC}$	Junction-to-Case Thermal Resistance			0.90	$^\circ C/W$
$R_{\theta JA}$	Junction-to-Ambient Thermal Resistance			20	
$V_{Isolation}$	RMS Voltage (50-60 Hz Sinusoidal Waveform from Terminals to Mounting Base for 1 Min.)	2500			Volts
$W_T$	Package Weight		1.03		oz
			29.2		gm
Torque	Maximum Torque (Mounting = 8-32 or 4mm Machine and Terminals = 4mm Machine)			13.6	lb•in
				1.5	N•m

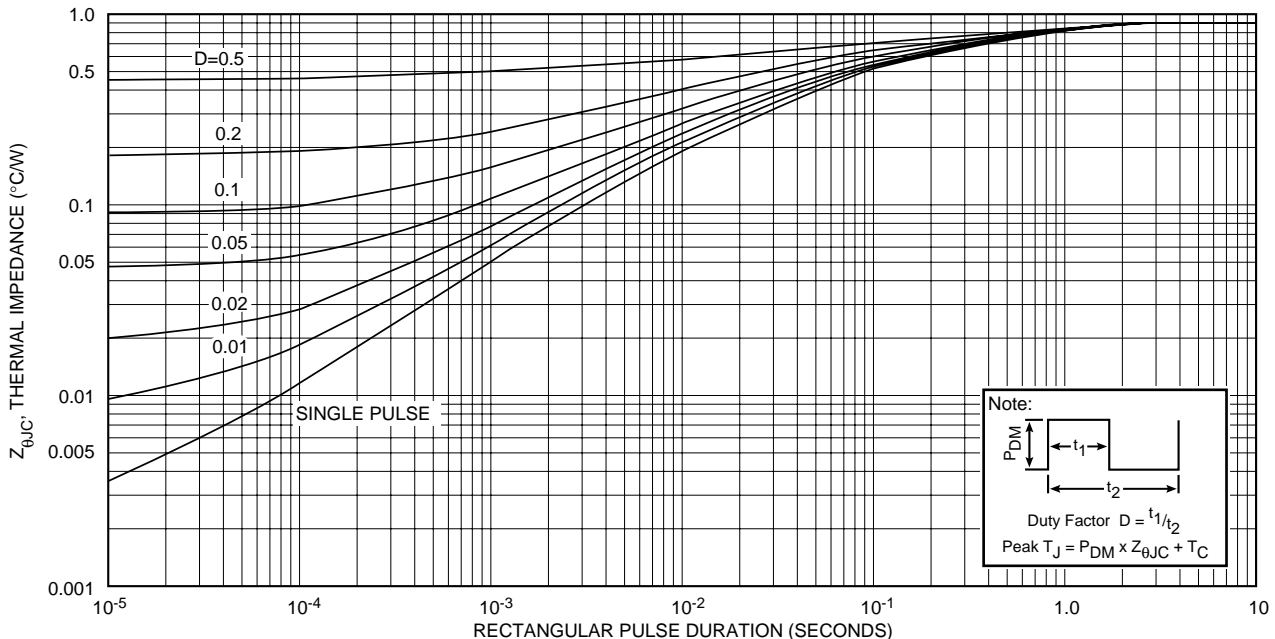

**APT2X30/2X31D60J**

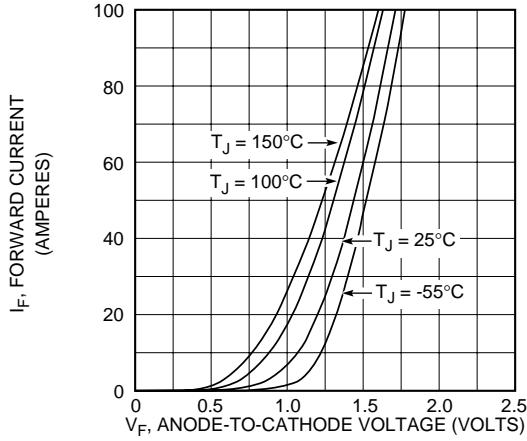

**Figure 2, Forward Voltage Drop vs Forward Current**

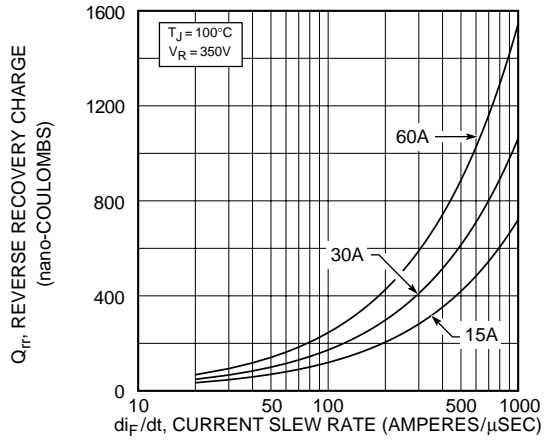

**Figure 3, Reverse Recovery Charge vs Current Slew Rate**

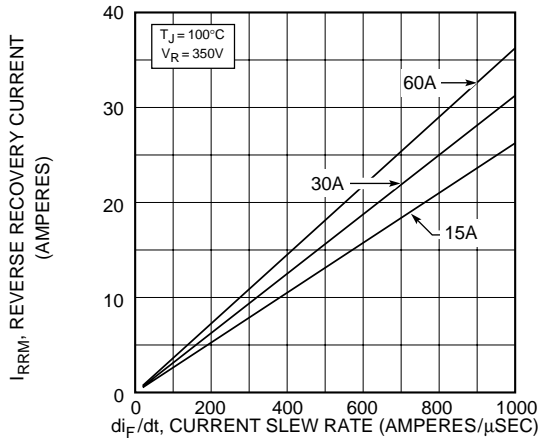

**Figure 4, Reverse Recovery Current vs Current Slew Rate**

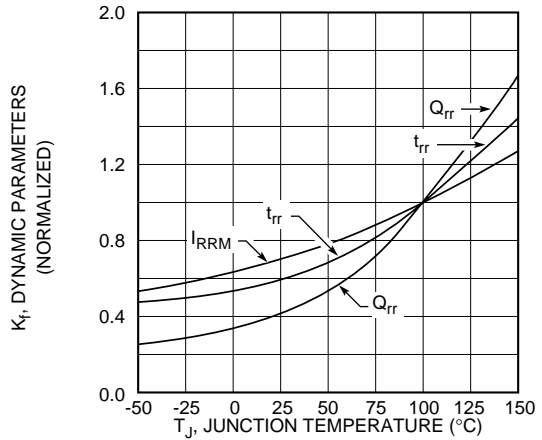

**Figure 5, Dynamic Parameters vs Junction Temperature**

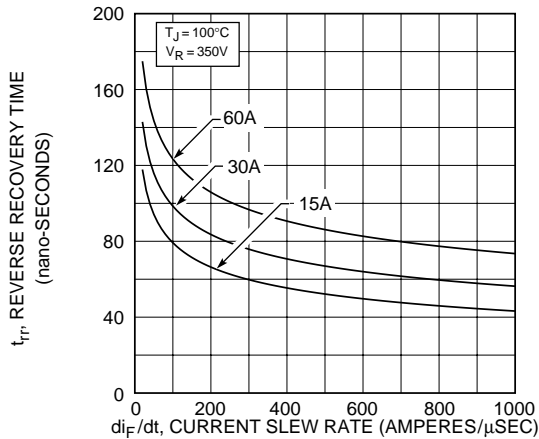

**Figure 6, Reverse Recovery Time vs Current Slew Rate**

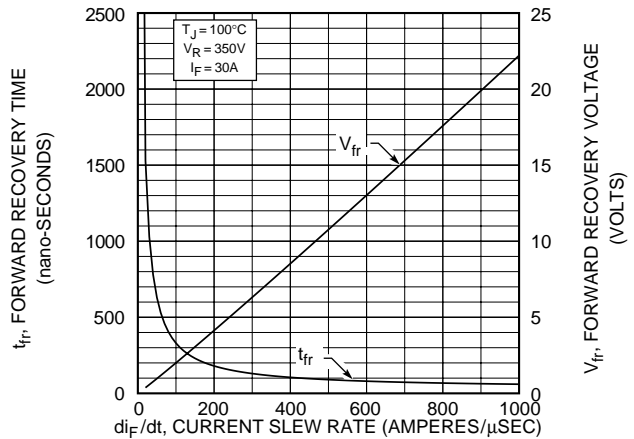

**Figure 7, Forward Recovery Voltage/Time vs Current Slew Rate**

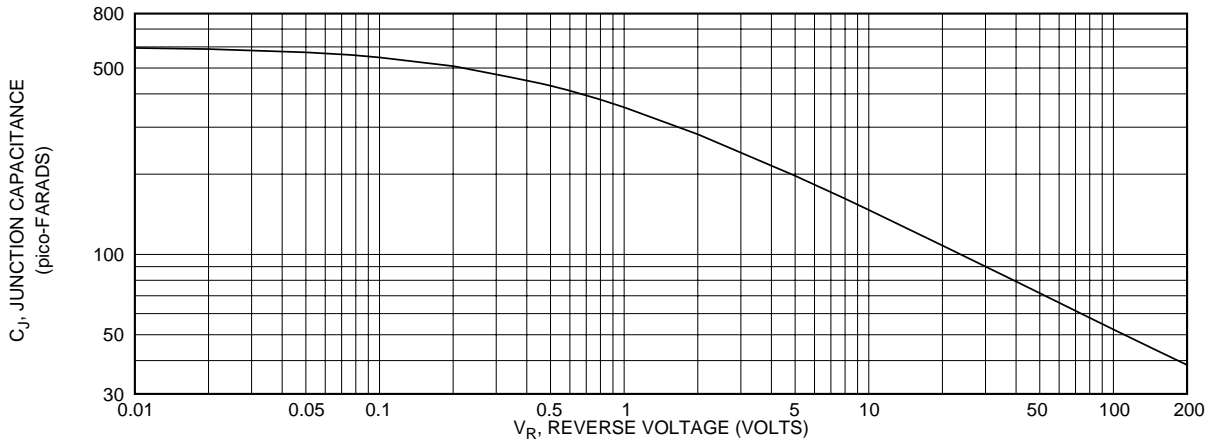

**Figure 8, Junction Capacitance vs Reverse Voltage**

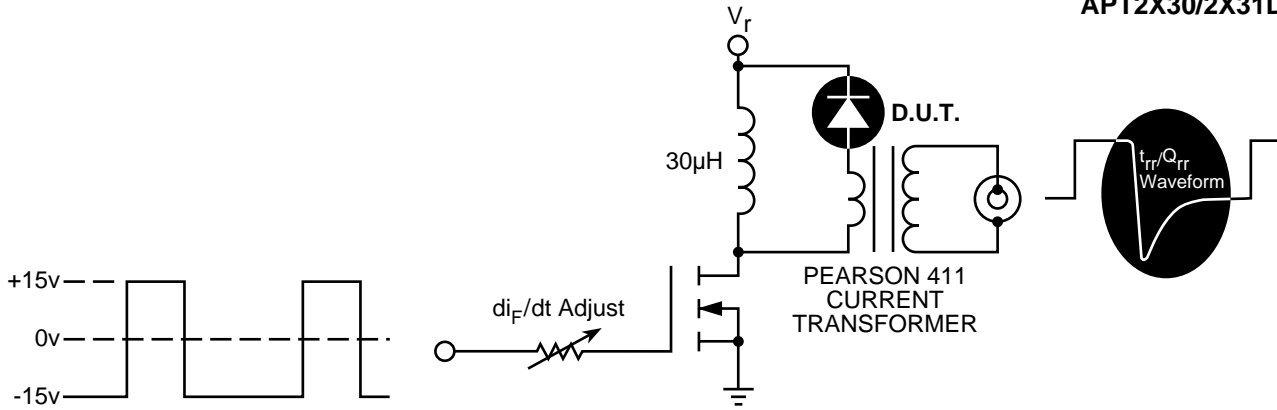

Figure 9, Diode Reverse Recovery Test Circuit and Waveforms

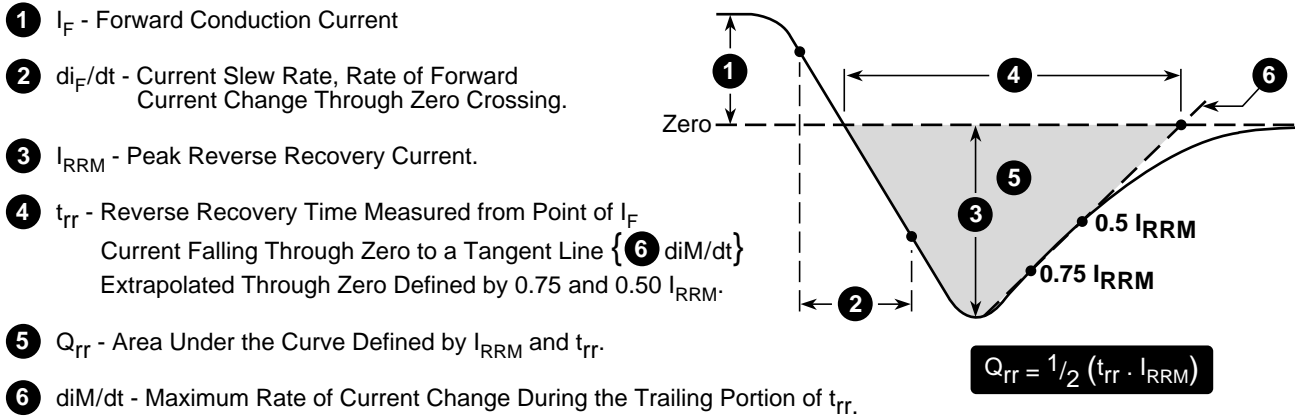
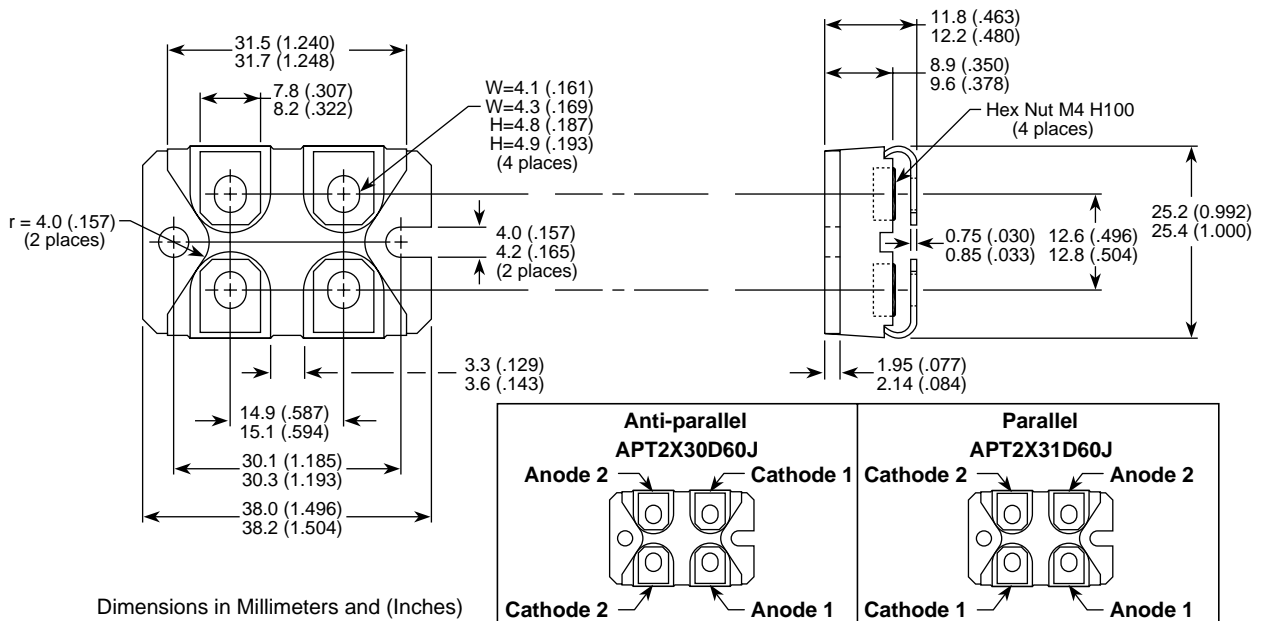

Figure 10, Diode Reverse Recovery Waveform and Definitions

APT Reserves the right to change, without notice, the specifications and information contained herein.

### SOT-227 Package Outline



This datasheet has been download from:

[www.datasheetcatalog.com](http://www.datasheetcatalog.com)

Datasheets for electronics components.