

## 74VHCT573A Octal D-Type Latch with 3-STATE Outputs

### General Description

The VHCT573A is an advanced high speed CMOS octal latch with 3-STATE output fabricated with silicon gate CMOS technology. It achieves the high speed operation similar to equivalent Bipolar Schottky TTL while maintaining the CMOS low power dissipation. This 8-bit D-type latch is controlled by a Latch Enable input (LE) and an Output Enable input ( $\overline{OE}$ ). When the  $\overline{OE}$  input is HIGH, the eight outputs are in a high impedance state.

Protection circuits ensure that 0V to 7V can be applied to the input and output (Note 1) pins without regard to the supply voltage. This device can be used to interface 3V to 5V systems and two supply systems such as battery back up. This circuit prevents device destruction due to mismatched supply and input voltages.

**Note 1:** Outputs in OFF-State.

### Features

- High speed:  $t_{PD} = 7.7$  ns (typ) at  $T_A = 25^\circ\text{C}$
- High Noise Immunity:  $V_{IH} = 2.0\text{V}$ ,  $V_{IL} = 0.8\text{V}$
- Power Down Protection is provided on all inputs and outputs
- Low Noise:  $V_{OLP} = 1.6\text{V}$  (max)
- Low Power Dissipation:  
 $I_{CC} = 4 \mu\text{A}$  (max) @  $T_A = 25^\circ\text{C}$
- Pin and function compatible with 74HCT573

### Ordering Code:

Order Number	Package Number	Package Description
74VHCT573AM	M20B	20-Lead Small Outline Integrated Circuit (SOIC), JEDEC MS-013, 0.300 Wide
74VHCT573ASJ	M20D	20-Lead Small Outline Package (SOP), EIAJ TYPE II, 5.3mm Wide
74VHCT573AMTC	MTC20	20-Lead Thin Shrink Small Outline Package (TSSOP), JEDEC MO-153, 4.4mm Wide
74VHCT573AN	N20A	20-Lead Plastic Dual-In-Line Package (PDIP), JEDEC MS-001, 0.300 Wide

Surface mount packages are also available on Tape and Reel. Specify by appending the suffix letter "X" to the ordering code.

### Logic Symbol

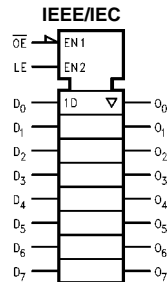

### Connection Diagram

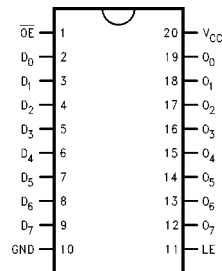

### Pin Descriptions

Pin Names	Description
$D_0$ – $D_7$	Data Inputs
LE	Latch Enable Input
$\overline{OE}$	3-STATE Output Enable Input
$O_0$ – $O_7$	3-STATE Outputs

## Functional Description

The VHCT573A contains eight D-type latches with 3-STATE output buffers. When the Latch Enable (LE) input is HIGH, data on the  $D_n$  inputs enters the latches. In this condition the latches are transparent, i.e., a latch output will change state each time its D input changes. When LE is LOW the latches store the information that was present on the D inputs, a setup time preceding the HIGH-to-LOW transition of LE. The 3-STATE buffers are controlled by the Output Enable ( $\overline{OE}$ ) input. When  $\overline{OE}$  is LOW, the buffers are enabled. When  $\overline{OE}$  is HIGH the buffers are in the high impedance mode, but, this does not interfere with entering new data into the latches.

## Truth Table

Inputs			Outputs
$\overline{OE}$	LE	D	$O_n$
L	H	H	H
L	H	L	L
L	L	X	$O_0$
H	X	X	Z

H = HIGH Voltage Level  
 L = LOW Voltage Level  
 X = Immaterial  
 Z = High Impedance

## Logic Diagram

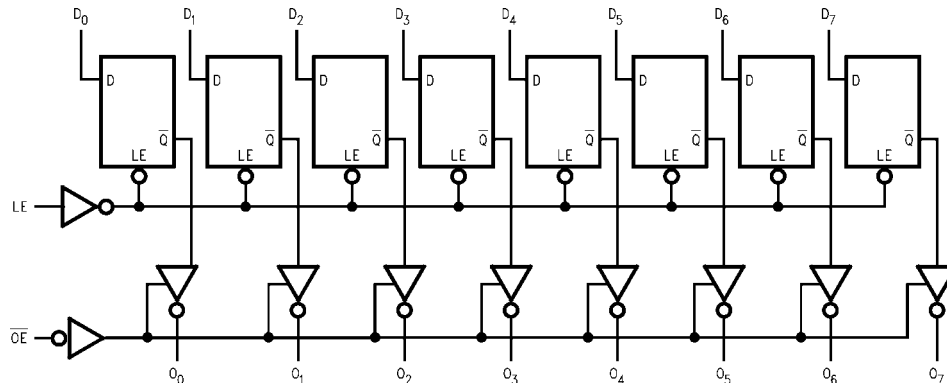

Please note that this diagram is provided only for the understanding of logic operations and should not be used to estimate propagation delays.

**Absolute Maximum Ratings** (Note 2)

Supply Voltage ( $V_{CC}$ )	-0.5V to +7.0V
DC Input Voltage ( $V_{IN}$ )	-0.5V to +7.0V
DC Output Voltage ( $V_{OUT}$ )	-0.5V to $V_{CC} + 0.5V$
(Note 3)	-0.5V to $V_{CC} + 0.5V$
(Note 4)	-0.5V to +7.0V
Input Diode Current ( $I_{IK}$ )	-20 mA
Output Diode Current ( $I_{OK}$ ) (Note 5)	$\pm 20$ mA
DC Output Current ( $I_{OUT}$ )	$\pm 25$ mA
DC $V_{CC}$ /GND Current ( $I_{CC}$ )	$\pm 75$ mA
Storage Temperature ( $T_{STG}$ )	-65°C to +150°C
Lead Temperature ( $T_L$ )	260°C
(Soldering, 10 seconds)	

**Recommended Operating Conditions** (Note 6)

Supply Voltage ( $V_{CC}$ )	4.5V to +5.5V
Input Voltage ( $V_{IN}$ )	0V to +5.5V
Output Voltage ( $V_{OUT}$ )	0V to $V_{CC}$
(Note 3)	0V to $V_{CC}$
(Note 4)	0V to 5.5V
Operating Temperature ( $T_{OPR}$ )	-40°C to +85°C
Input Rise and Fall Time ( $t_r, t_f$ )	0 ns/V ~ 20 ns/V
$V_{CC} = 5.0V \pm 0.5V$	

**Note 2:** Absolute Maximum Ratings are values beyond which the device may be damaged or have its useful life impaired. The databook specifications should be met, without exception, to ensure that the system design is reliable over its power supply, temperature, and output/input loading variables. Fairchild does not recommend operation outside databook specifications.

**Note 3:** HIGH or LOW state.  $I_{OUT}$  absolute maximum rating must be observed.

**Note 4:** When outputs are in OFF-State or when  $V_{CC} = 0V$ .

**Note 5:**  $V_{OUT} < GND$ ,  $V_{OUT} > V_{CC}$  (Outputs Active).

**Note 6:** Unused inputs must be held HIGH or LOW. They may not float.

**DC Electrical Characteristics**

Symbol	Parameter	$V_{CC}$ (V)	$T_A = 25^\circ C$			$T_A = -40^\circ C$ to $+85^\circ C$		Units	Conditions	
			Min	Typ	Max	Min	Max			
$V_{IH}$	HIGH Level Input Voltage	4.5	2.0			2.0		V		
		5.5	2.0			2.0				
$V_{IL}$	LOW Level Input Voltage	4.5			0.8		0.8	V		
		5.5			0.8		0.8			
$V_{OH}$	HIGH Level Output Voltage	4.5	4.40	4.50		4.40		V	$V_{IN} = V_{IH}$ or $V_{IL}$	$I_{OH} = -50 \mu A$ $I_{OH} = -8 \text{ mA}$
		4.5	3.94			3.80				
$V_{OL}$	LOW Level Output Voltage	4.5		0.0	0.1		0.1	V	$V_{IN} = V_{IH}$ or $V_{IL}$	$I_{OL} = 50 \mu A$ $I_{OL} = 8 \text{ mA}$
		4.5			0.36		0.44			
$I_{OZ}$	3-STATE Output Off-State Current	5.5			$\pm 0.25$		$\pm 2.5$	$\mu A$	$V_{IN} = V_{IH}$ or $V_{IL}$ $V_{OUT} = V_{CC}$ or GND	
$I_{IN}$	Input Leakage Current	0 – 5.5			$\pm 0.1$		$\pm 1.0$	$\mu A$	$V_{IN} = 5.5V$ or GND	
$I_{CC}$	Quiescent Supply Current	5.5			4.0		40.0	$\mu A$	$V_{IN} = V_{CC}$ or GND	
$I_{CCT}$	Maximum $I_{CC}$ /Input	5.5			1.35		1.50	mA	$V_{IN} = 3.4V$ Other Inputs = $V_{CC}$ or GND	
$I_{OFF}$	Output Leakage Current (Power Down State)	0.0			0.5		5.0	$\mu A$	$V_{OUT} = 5.5V$	

**Noise Characteristics**

Symbol	Parameter	$V_{CC}$ (V)	$T_A = 25^\circ C$		Units	Conditions
			Typ	Limits		
$V_{OLP}$ (Note 7)	Quiet Output Maximum Dynamic $V_{OL}$	5.0	1.2	1.6	V	$C_L = 50 \text{ pF}$
$V_{OLV}$ (Note 7)	Quiet Output Minimum Dynamic $V_{OL}$	5.0	-1.2	-1.6	V	$C_L = 50 \text{ pF}$
$V_{IHD}$ (Note 7)	Minimum HIGH Level Dynamic Input Voltage	5.0		2.0	V	$C_L = 50 \text{ pF}$
$V_{ILD}$ (Note 7)	Maximum LOW Level Dynamic Input Voltage	5.0		0.8	V	$C_L = 50 \text{ pF}$

**Note 7:** Parameter guaranteed by design.

## AC Electrical Characteristics

Symbol	Parameter	V <sub>CC</sub> (V)	T <sub>A</sub> = 25°C			T <sub>A</sub> = -40°C to +85°C		Units	Conditions
			Min	Typ	Max	Min	Max		
t <sub>PLH</sub>	Propagation Delay Time (LE to O <sub>n</sub> )	5.0 ± 0.5	7.7	12.3	1.0	13.5	ns	C <sub>L</sub> = 15 pF	
t <sub>PHL</sub>			8.5	13.3	1.0	14.5		C <sub>L</sub> = 50 pF	
t <sub>PLH</sub>	Propagation Delay Time (D to O <sub>n</sub> )	5.0 ± 0.5	5.1	8.5	1.0	9.5	ns	C <sub>L</sub> = 15 pF	
t <sub>PHL</sub>			5.9	9.5	1.0	10.5		C <sub>L</sub> = 50 pF	
t <sub>PZL</sub>	3-STATE Output	5.0 ± 0.5	6.3	10.9	1.0	12.5	ns	R <sub>L</sub> = 1 kΩ C <sub>L</sub> = 15 pF	
t <sub>PZH</sub>	Enable Time		7.1	11.9	1.0	13.5		C <sub>L</sub> = 50 pF	
t <sub>PLZ</sub>	3-STATE Output	5.0 ± 0.5	8.8	11.2	1.0	12.0	ns	R <sub>L</sub> = 1 kΩ C <sub>L</sub> = 50 pF	
t <sub>PHZ</sub>	Disable Time								
t <sub>OSLH</sub>	Output to Output Skew	5.0 ± 0.5		1.0		1.0	ns	(Note 8)	
t <sub>OSHL</sub>									
C <sub>IN</sub>	Input Capacitance		4	10		10	pF	V <sub>CC</sub> = Open	
C <sub>OUT</sub>	Output Capacitance			6			pF	V <sub>CC</sub> = 5.0V	
C <sub>PD</sub>	Power Dissipation Capacitance			25			pF	(Note 9)	

**Note 8:** Parameter guaranteed by design.  $t_{OSLH} = |t_{PLH\ max} - t_{PLH\ min}|$ ;  $t_{OSHL} = |t_{PHL\ max} - t_{PHL\ min}|$

**Note 9:** C<sub>PD</sub> is defined as the value of the internal equivalent capacitance which is calculated from the operating current consumption without load. Average operating current can be obtained by the equation:  $I_{CC\ (opr.)} = C_{PD} \cdot V_{CC} \cdot f_{IN} + I_{CC}/8$  (per F/F). The total C<sub>PD</sub> when n pcs. of the Latch operates can be calculated by the equation:  $C_{PD\ (total)} = 14 + 13n$ .

## AC Operating Requirements

Symbol	Parameter	V <sub>CC</sub> (V)	T <sub>A</sub> = 25°C			T <sub>A</sub> = -40°C to +85°C		Units
			Min	Typ	Max	Min	Max	
t <sub>W(H)</sub>	Minimum Pulse Width (LE)	5.0 ± 0.5	6.5			8.5	ns	
t <sub>S</sub>	Minimum Setup Time	5.0 ± 0.5	1.5			1.5	ns	
t <sub>H</sub>	Minimum Hold Time	5.0 ± 0.5	3.5			3.5	ns	

**Physical Dimensions** inches (millimeters) unless otherwise noted

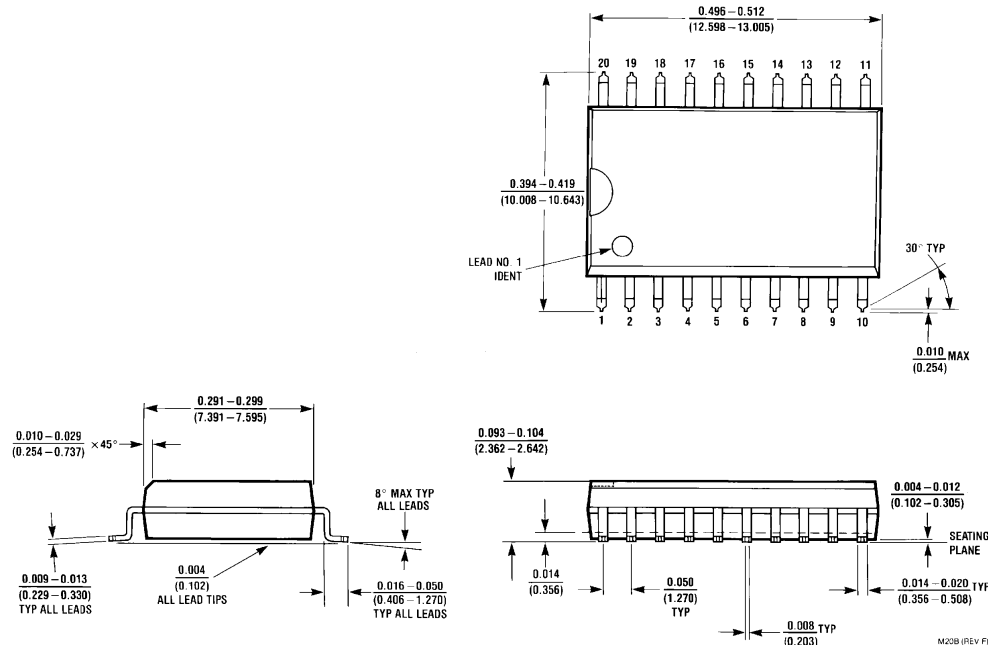

**20-Lead Small Outline Integrated Circuit (SOIC), JEDEC MS-013, 0.300 Wide Package Number M20B**

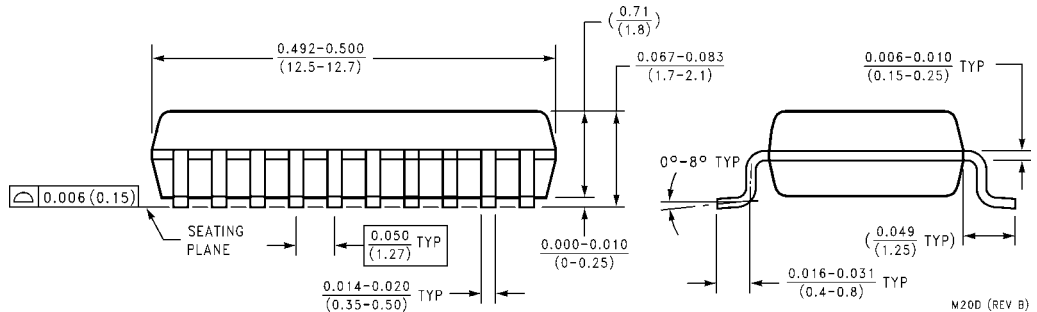
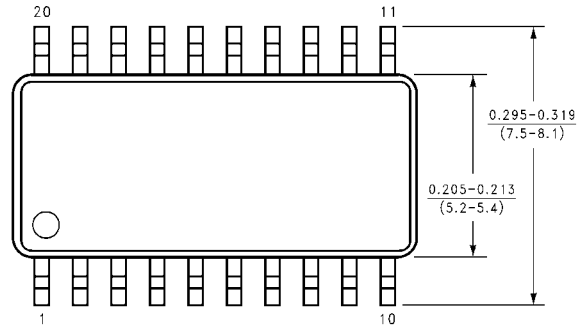

**20-Lead Small Outline Package (SOP), EIAJ TYPE II, 5.3mm Wide Package Number M20D**

**Physical Dimensions** inches (millimeters) unless otherwise noted (Continued)

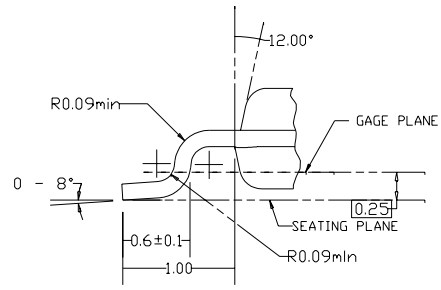
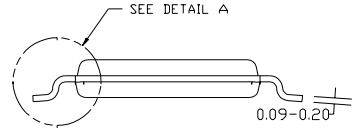
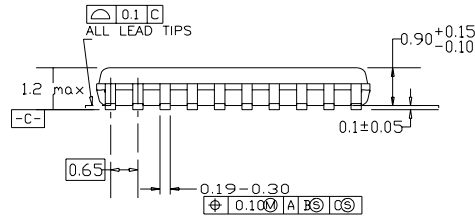
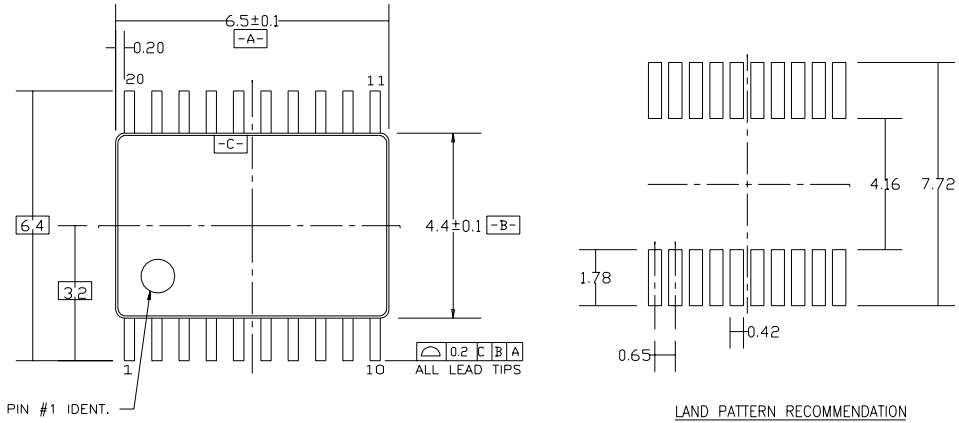

DIMENSIONS ARE IN MILLIMETERS

NOTES:

- A. CONFORMS TO JEDEC REGISTRATION MO-153, VARIATION AC, REF NOTE 6, DATE 7/93.
- B. DIMENSIONS ARE IN MILLIMETERS.
- C. DIMENSIONS ARE EXCLUSIVE OF BURRS, MOLDS FLASH, AND TIE BAR EXTRUSIONS.
- D. DIMENSIONS AND TOLERANCES PER ANSI Y14.5M, 1982.

MTC20REV D1

**20-Lead Thin Shrink Small Outline Package (TSSOP), JEDEC MO-153, 4.4mm Wide  
Package Number MTC20**

**Physical Dimensions** inches (millimeters) unless otherwise noted (Continued)

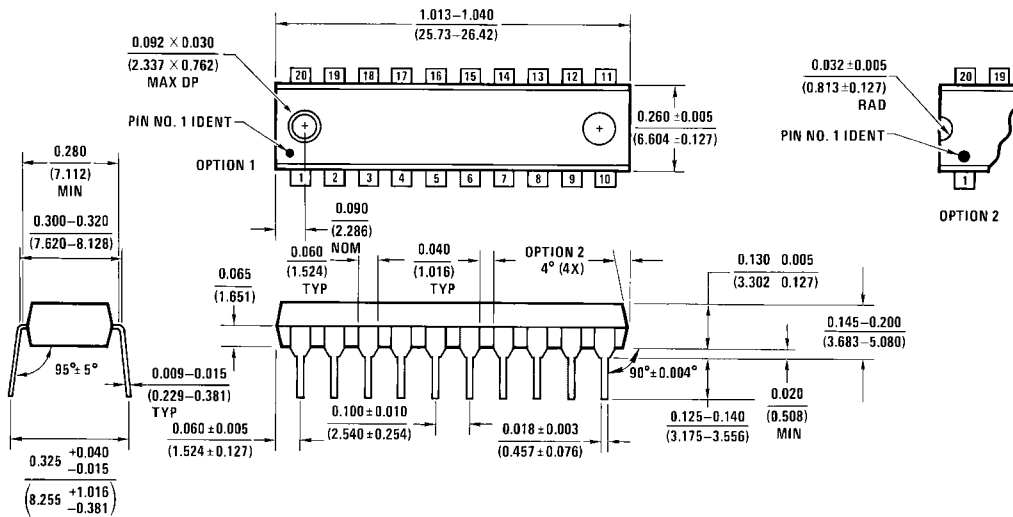

20-Lead Plastic Dual-In-Line Package (PDIP), JEDEC MS-001, 0.300 Wide Package Number N20A

**LIFE SUPPORT POLICY**

FAIRCHILD'S PRODUCTS ARE NOT AUTHORIZED FOR USE AS CRITICAL COMPONENTS IN LIFE SUPPORT DEVICES OR SYSTEMS WITHOUT THE EXPRESS WRITTEN APPROVAL OF THE PRESIDENT OF FAIRCHILD SEMICONDUCTOR CORPORATION. As used herein:

1. Life support devices or systems are devices or systems which, (a) are intended for surgical implant into the body, or (b) support or sustain life, and (c) whose failure to perform when properly used in accordance with instructions for use provided in the labeling, can be reasonably expected to result in a significant injury to the user.
2. A critical component in any component of a life support device or system whose failure to perform can be reasonably expected to cause the failure of the life support device or system, or to affect its safety or effectiveness.

[www.fairchildsemi.com](http://www.fairchildsemi.com)

This datasheet has been download from:

[www.datasheetcatalog.com](http://www.datasheetcatalog.com)

Datasheets for electronics components.