

Axial Lead Diode

Rectifier Diode

SK1 CCE

SK 1

Features

- Reverse voltages up to 1600 V
- Taped for automatic insertion
- Available with formed leads on request
- Plastic material used carries Underwriter Laboratories flammability classification 94V-0

Typical Applications

- All-purpose rectifier diodes

V_{RSM} V	V_{RRM} V	$I_{FRMS} = 3$ A (maximum value for continuous operation) $I_{FAV} = 1$ A (sin. 180; $T_a = 60$ °C)	
1000	1000	SK 1/10	
1200	1200	SK 1/12	
1400	1400	SK 1/14	
1600	1600	SK 1/16	

Symbol	Conditions	Values	Units
I_{FAV}	sin. 180; L = 10 mm; $T_r = 85$ (100) °C	1,45 (1,2)	A
I_{FSM}	$T_{vj} = 25$ °C; 10 ms	60	A
	$T_{vj} = 150$ °C; 10 ms	50	A
i^2t	$T_{vj} = 25$ °C; 8,3 ... 10 ms	18	A ² s
	$T_{vj} = 150$ °C; 8,3 ... 10 ms	12,5	A ² s
V_F	$T_{vj} = 25$ °C; $I_F = 10$ A	max. 1,5	V
$V_{(TO)}$	$T_{vj} = 150$ °C	max. 0,85	V
r_T	$T_{vj} = 150$ °C	max. 75	mΩ
I_{RD}	$T_{vj} = 150$ °C; $V_{RD} = V_{RRM}$	max. 0,4	mA
Q_{rr}	$T_{vj} = 150$ °C; $-di_F/dt = 10$ A/μs; $I_F = 10$ A	10	μC
$R_{th(j-r)}$	L = 10 mm	40	K/W
$R_{th(j-a)}$	PCB 50 x 50 mm	85	K/W
T_{vj}		- 40 ... + 150	°C
T_{stg}		- 40 ... + 150	°C
T_{sold}	max. 10 s; L > 9mm	250	°C
V_{isol}		-	V~
a		5 * 9,81	m/s ²
m	approx.	0,5	g
Case	3500 diodes per reel	E 33	

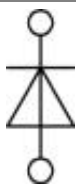

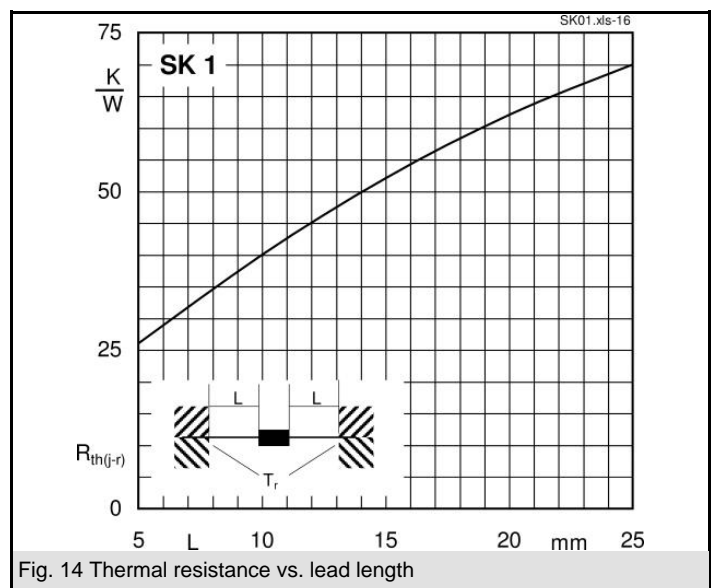
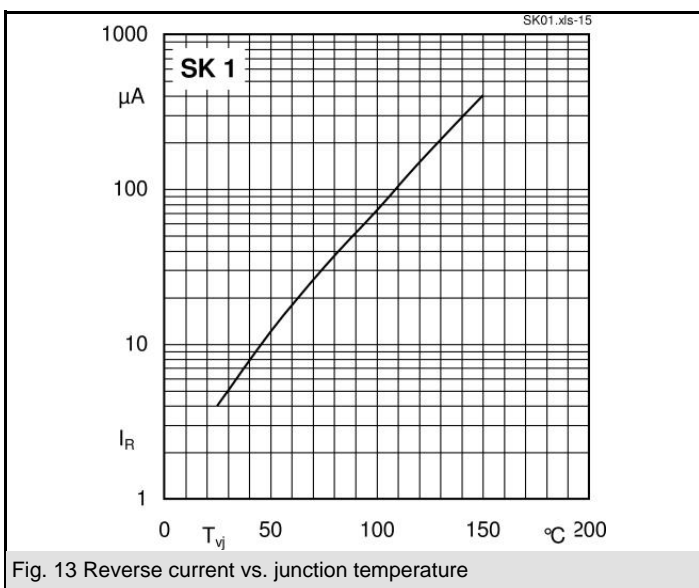
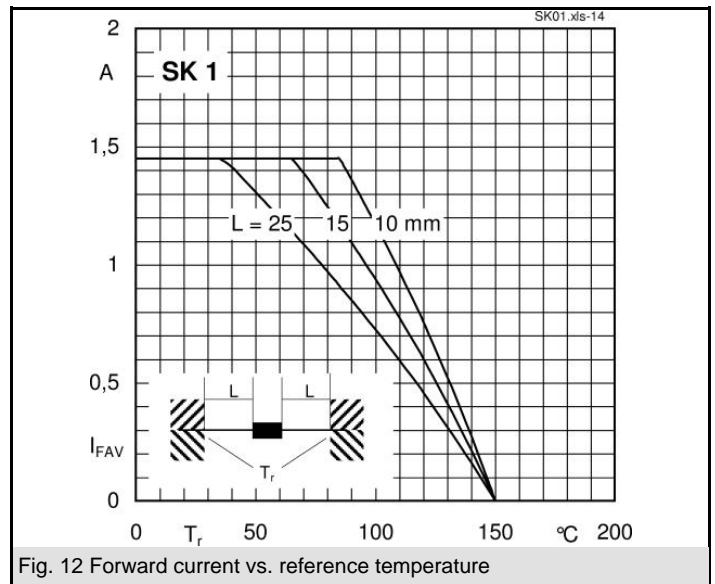
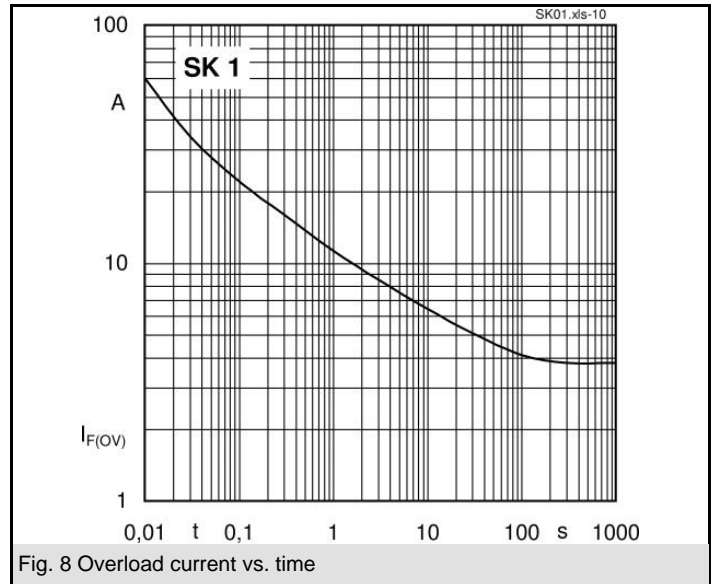
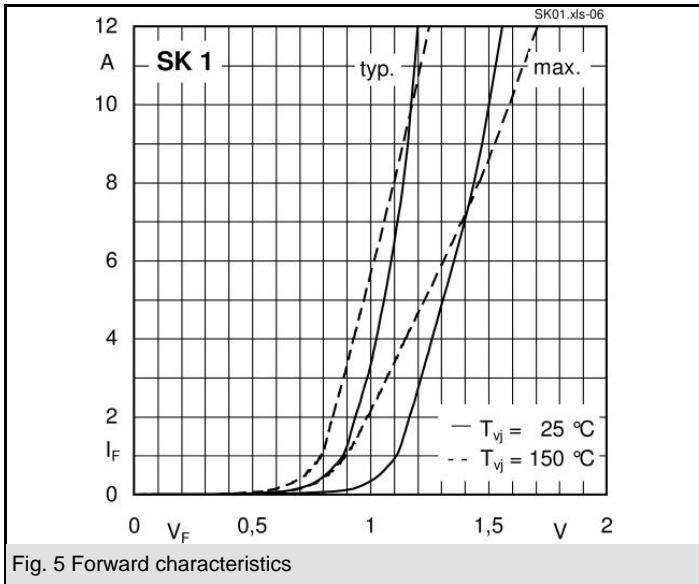

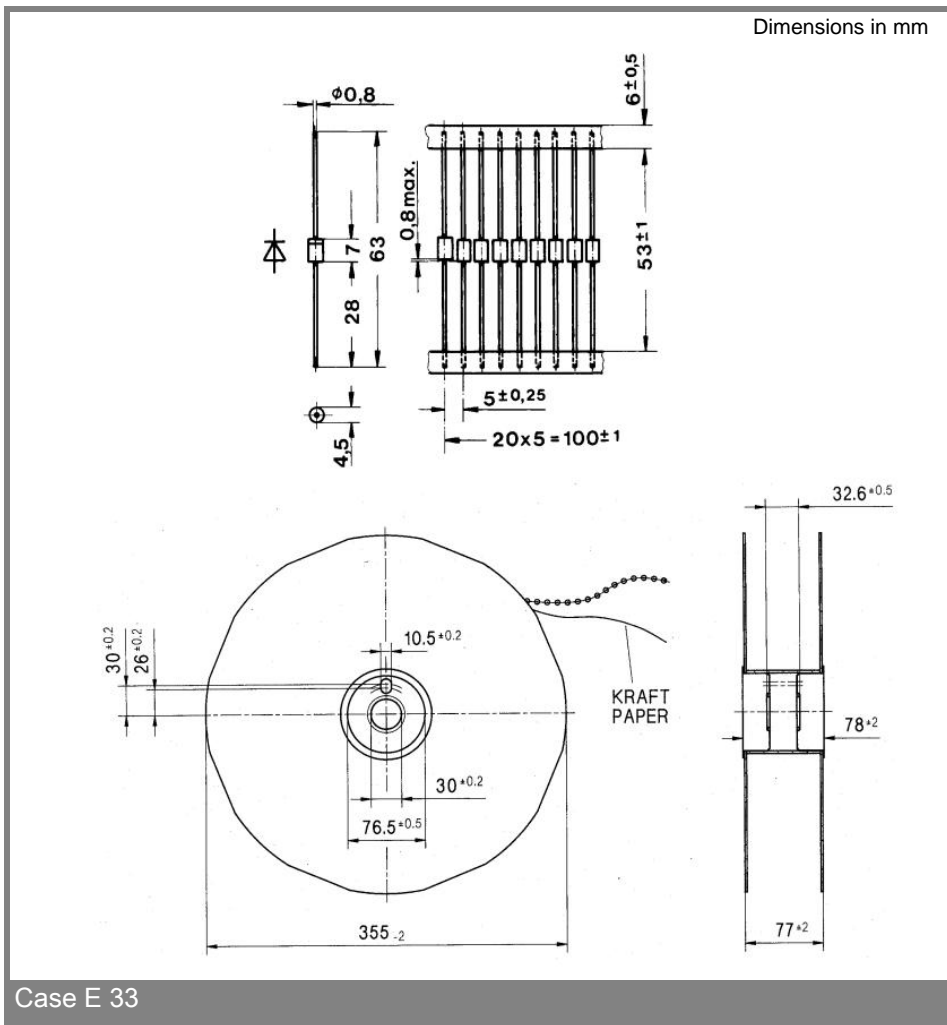

Case E 33

This technical information specifies semiconductor devices but promises no characteristics. No warranty or guarantee expressed or implied is made regarding delivery, performance or suitability.