

Ka Band Wideband LNA/Driver

TGA1319C-EPU

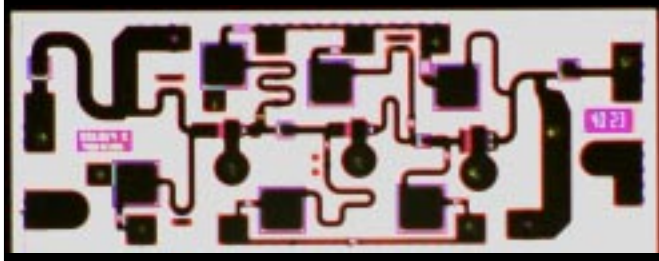

Chip Dimensions 2.179 mm x .847 mm

Key Features and Performance

- 0.15um pHEMT Technology
- 16-30 GHz Frequency Range
- 2.25 dB Nominal Noise Figure midband
- 21 dB Nominal Gain
- 14 dBm Pout
- Bias 5V, 60 mA with $-0.5V < V_g < +0.5V$

Primary Applications

- Point-to-Point Radio
- Point-to-Multipoint Communications

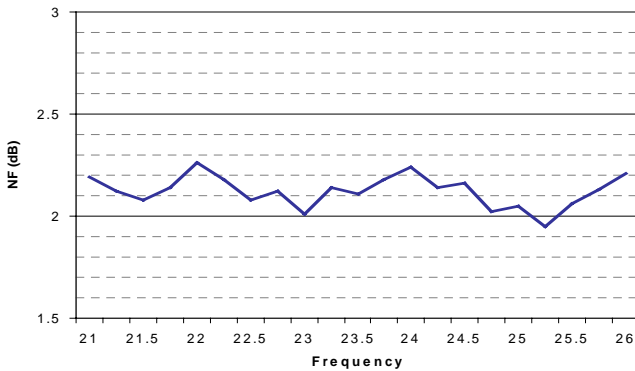

Typical NF @ 25C

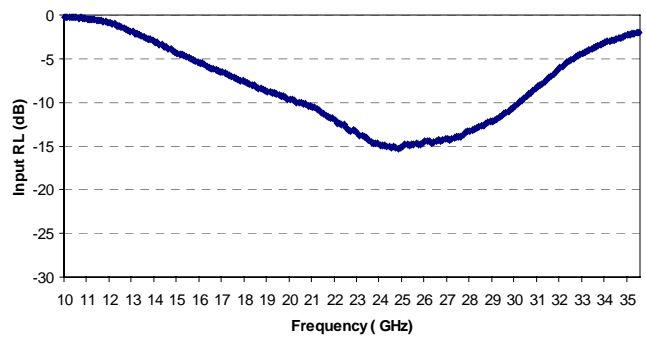

Typical S11 @ 25C

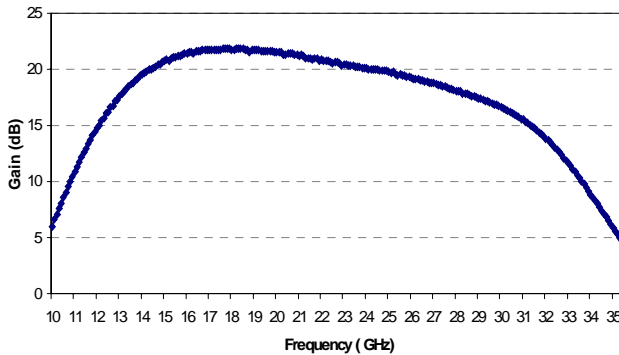

Typical Gain @ 25C

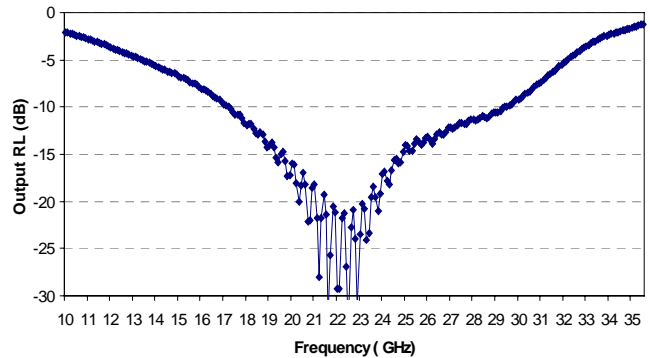

Typical S22 @ 25C

Note: Devices designated as EPU are typically early in their characterization process prior to finalizing all electrical and process specifications. Specifications subject to change without notice

MAXIMUM RATINGS

SYMBOL	PARAMETER ^{4/}	VALUE	NOTES
V ⁺	POSITIVE SUPPLY VOLTAGE	9 V	
I ⁺	POSITIVE SUPPLY CURRENT	80 mA	<u>1/</u>
I ⁻	NEGATIVE GATE CURRENT	5.28 mA	
P _{IN}	INPUT CONTINUOUS WAVE POWER	18 dBm	
P _D	POWER DISSIPATION	.72 W	
T _{CH}	OPERATING CHANNEL TEMPERATURE	150 °C	<u>2/</u> <u>3/</u>
T _M	MOUNTING TEMPERATURE (30 SECONDS)	320 °C	
T _{STG}	STORAGE TEMPERATURE	-65 to 150 °C	

1/ Total current for all stages.

2/ These ratings apply to each individual FET.

3/ Junction operating temperature will directly affect the device median time to failure (T_M). For maximum life, it is recommended that junction temperatures be maintained at the lowest possible levels.

4/ These ratings represent the maximum operable values for the device.

DC PROBE TESTS

(T_A = 25 °C ± 5°C)

Symbol	Parameter	Minimum	Maximum	Value
I _{SS}	Saturated Drain Current	---	---	mA
V _p	Pinch-off Voltage	-1.5	-0.5	V
BVGS	Breakdown Voltage gate-source	---	---	V
BVGD	Breakdown Voltage gate-drain	---	---	V

ON-WAFER RF PROBE CHARACTERISTICS

(T_A = 25 °C ± 5°C)

V_d = 5 V, I_{d1} = 10 mA, I_{d2} = 50 mA

Symbol	Parameter	Test Condition	Limit			Units
			Min	Typ	Max	
Gain	Small Signal Gain	F = 21 – 27 GHz	19		---	dB
NF	Noise Figure	F = 21 – 25 GHz	---		2.5	dB
		F = 26 – 26.5 GHz	---		2	
PWR	Output Power @ P1dB	F = 21 – 26 GHz	10		---	dBm
		F = 27 GHz	9		---	

Note: Devices designated as EPU are typically early in their characterization process prior to finalizing all electrical and process specifications. Specifications subject to change without notice

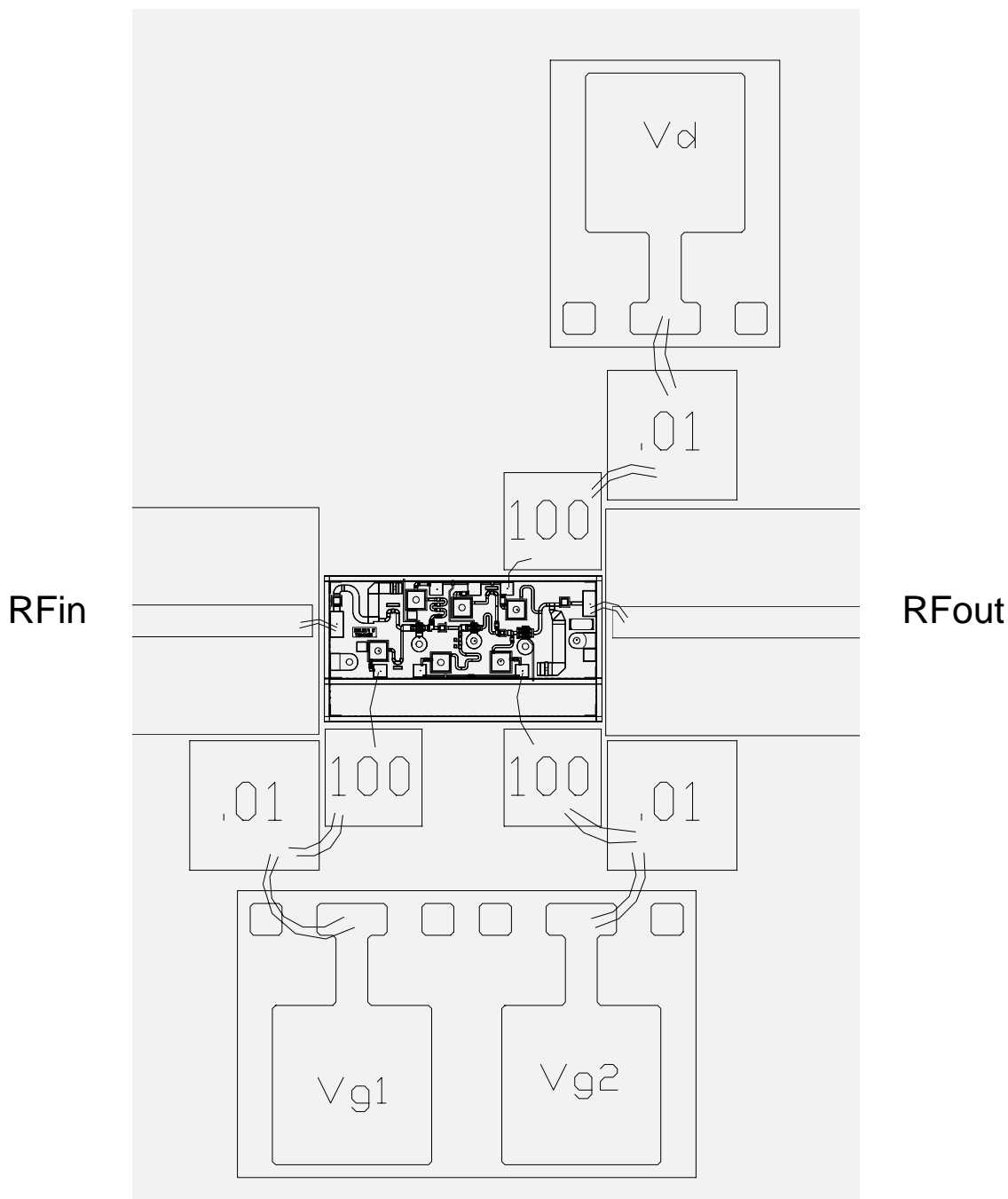

- Notes: 1. Vg1 and Vg2 may be sourced from the same supply.
 2. Positive or negative gate bias may be required to achieve recommended operating point.

TGA1319C- Recommended Assembly Drawing

Note: Devices designated as EPU are typically early in their characterization process prior to finalizing all electrical and process specifications. Specifications subject to change without notice

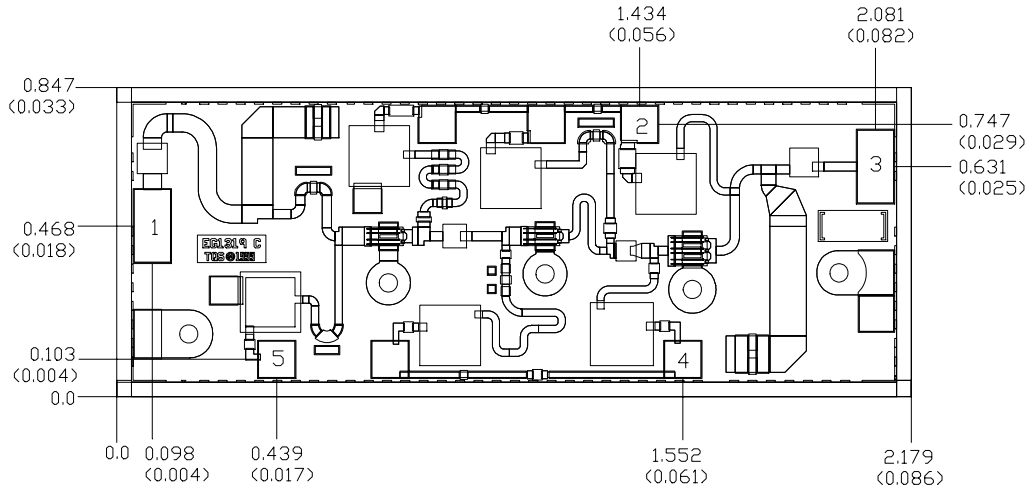

Units: millimeters (inches)

Thickness: 0.1016 (0.004)

Chip edge to bond pad dimensions are shown to center of bond pad

Chip size tolerance: +/- 0.051 (0.002)

Bond Pad #1 (RF Input)	0.100 x 0.200 (0.004 x 0.008)
Bond Pad #2 (Vd)	0.100 x 0.100 (0.004 x 0.004)
Bond Pad #3 (RF Output)	0.100 x 0.200 (0.004 x 0.008)
Bond Pad #4 (Vg2)	0.100 x 0.100 (0.004 x 0.004)
Bond Pad #5 (Vg1)	0.100 x 0.100 (0.004 x 0.004)

Mechanical Drawing

Note: Devices designated as EPU are typically early in their characterization process prior to finalizing all electrical and process specifications. Specifications subject to change without notice

Assembly Process Notes

Reflow process assembly notes:

- Use AuSn (80/20) solder with limited exposure to temperatures at or above 300°C.
- An alloy station or conveyor furnace with reducing atmosphere should be used.
- No fluxes should be utilized.
- Coefficient of thermal expansion matching is critical for long-term reliability.
- Devices must be stored in a dry nitrogen atmosphere.

Component placement and adhesive attachment assembly notes:

- Vacuum pencils and/or vacuum collets are the preferred method of pick up.
- Air bridges must be avoided during placement.
- The force impact is critical during auto placement.
- Organic attachment can be used in low-power applications.
- Curing should be done in a convection oven; proper exhaust is a safety concern.
- Microwave or radiant curing should not be used because of differential heating.
- Coefficient of thermal expansion matching is critical.

Interconnect process assembly notes:

- Thermosonic ball bonding is the preferred interconnect technique.
- Force, time, and ultrasonics are critical parameters.
- Aluminum wire should not be used.
- Discrete FET devices with small pad sizes should be bonded with 0.0007-inch wire.
- Maximum stage temperature is 200°C.

GaAs MMIC devices are susceptible to damage from Electrostatic Discharge. Proper precautions should be observed during handling, assembly and test.

Assembly Process Notes

Reflow process assembly notes:

- AuSn (80/20) solder with limited exposure to temperatures at or above 300°C
- alloy station or conveyor furnace with reducing atmosphere
- no fluxes should be utilized
- coefficient of thermal expansion matching is critical for long-term reliability
- storage in dry nitrogen atmosphere

Component placement and adhesive attachment assembly notes:

- vacuum pencils and/or vacuum collets preferred method of pick up
- avoidance of air bridges during placement
- force impact critical during auto placement
- organic attachment can be used in low-power applications
- curing should be done in a convection oven; proper exhaust is a safety concern
- microwave or radiant curing should not be used because of differential heating
- coefficient of thermal expansion matching is critical

Interconnect process assembly notes:

- thermosonic ball bonding is the preferred interconnect technique
- force, time, and ultrasonics are critical parameters
- aluminum wire should not be used
- discrete FET devices with small pad sizes should be bonded with 0.0007-inch wire
- maximum stage temperature: 200°C

GaAs MMIC devices are susceptible to damage from Electrostatic Discharge. Proper precautions should be observed during handling, assembly and test.

Note: Devices designated as EPU are typically early in their characterization process prior to finalizing all electrical and process specifications. Specifications are subject to change without notice.