

### Silicon Schottky Diode, 400A

#### Features

- Guard Ring Protection
- Low forward voltage drop
- High surge current capability
- Up to 100V  $V_{RRM}$



TWIN TOWER PACKAGE

Maximum Ratings ( $T_J = 25^\circ\text{C}$ unless otherwise specified)							
Parameter	Symbol	Conditions	MBR40020CT (R)	MBR40030CT (R)	MBR40035CT (R)	MBR40040CT (R)	Units
Repetitive peak reverse voltage	$V_{RRM}$		20	30	35	40	V
RMS reverse voltage	$V_{RMS}$		14	21	25	28	V
DC blocking voltage	$V_{DC}$		20	30	35	40	V
Average forward current	$I_{F(AV)}$	$T_C \leq 125^\circ\text{C}$	400	400	400	400	A
Non-repetitive forward surge current, half sine-wave	$I_{FSM}$	$T_C = 25^\circ\text{C}$ $t_p = 8.3\text{ ms}$	3000	3000	3000	3000	A

Electrical Characteristics ( $T_J = 25^\circ\text{C}$ unless otherwise specified)							
Parameter	Symbol	Conditions	MBR40020CT (R)	MBR40030CT (R)	MBR40035CT (R)	MBR40040CT (R)	Units
DC forward voltage	$V_F$	$I_F = 200\text{ A}$ $T_J = 25^\circ\text{C}$	0.68	0.68	0.68	0.68	V
DC reverse current	$I_R$	$V_R = 20\text{ V}$ $T_J = 25^\circ\text{C}$	5	5	5	5	mA
		$V_R = 20\text{ V}$ $T_J = 125^\circ\text{C}$	200	200	200	200	

Thermal Characteristics ( $T_J = 25^\circ\text{C}$ unless otherwise specified)							
Parameter	Symbol		MBR40020CT (R)	MBR40030CT (R)	MBR40035CT (R)	MBR40040CT (R)	Units
Thermal resistance junction to case	$R_{th-j-c}$		0.35	0.35	0.35	0.35	$^\circ\text{C}/\text{W}$
Operating, storage temperature range	$T_J, T_{stg}$		- 40 to +175	- 40 to +175	- 40 to +175	- 40 to +175	$^\circ\text{C}$

**Package Outline**

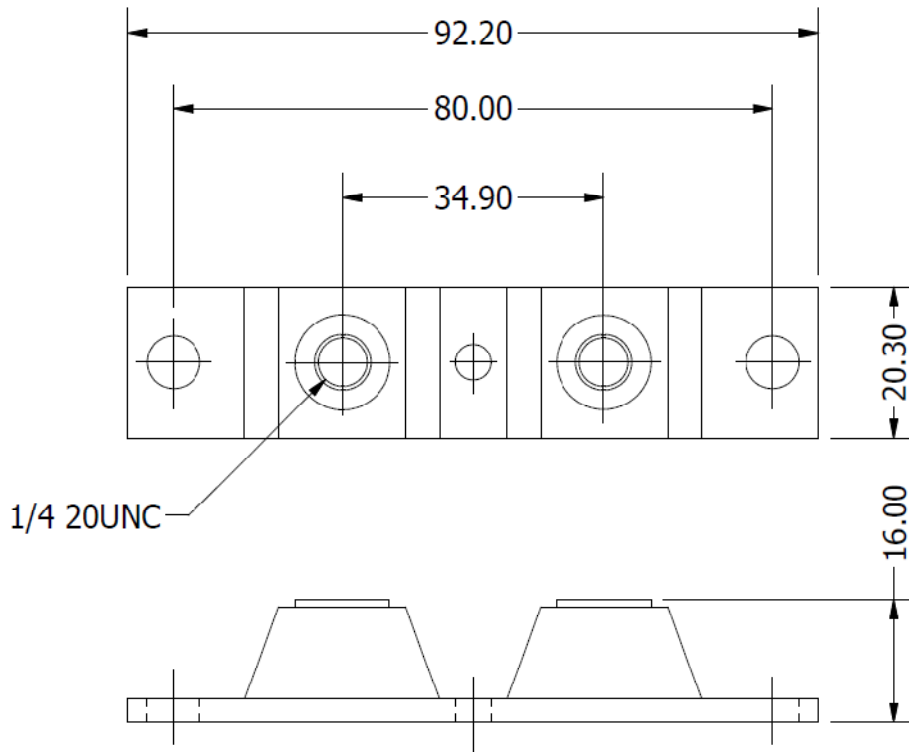

ALL DIMENSIONS IN MM

**Ordering Table**

<i>MBR</i>	<i>400</i>	<i>20</i>	<i>CT</i>
<b>1</b>	<b>2</b>	<b>3</b>	<b>4</b>

- 1 – Device Type
  - > MBR = Schottky Barrier Diode Module
- 2 – Current Rating =  $I_{F(AV)}$
- 3 – Voltage =  $V_{RRM}$
- 4 – Polarity
  - > CT = Normal (Cathode to Base)
  - > CTR = Reverse (Anode to Base)