

Dual 1 Form A Solid State Relay

Features

- Dual Channel (LH1550)
- Current Limit Protection
- Isolation Test Voltage 5300 V_{RMS}
- Typical R_{ON} 28 Ω
- Load Voltage 350 V
- Load Current 90 mA
- High Surge Capability
- Linear, AC/DC Operation
- Clean Bounce Free Switching
- Low Power Consumption
- SMD Lead Available on Tape and Reel

Agency Approvals

- UL - File No. E52744 System Code H or J
- CSA - Certification 093751
- BSI/BABT Cert. No. 7980
- DIN EN 60747-5-5 (VDE 0884):2003-01 Available with Option 1
- FIMKO Approval

Applications

General Telecom Switching

- On/off Hook Control
- Ring Delay
- Dial Pulse
- Ground Start
- Ground Fault Protection

Instrumentation

Industrial Controls

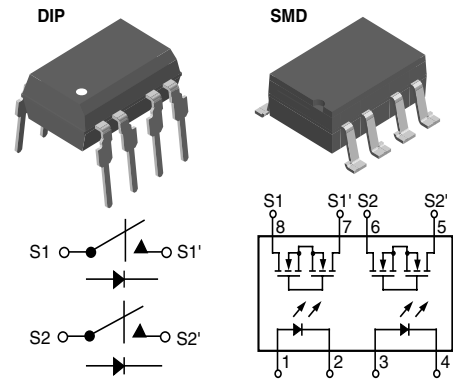

Description

The LH1533 (Dual 1 Form A) relays are SPST normally open switches that can replace electromechanical relays in many applications. They are constructed using a GaAlAs LED for actuation control and an integrated monolithic die for the switch output. The die, fabricated in a high-voltage dielectrically isolated technology is comprised of a photodiode array, switch control circuitry, and MOSFET switches. In addition, the relays employ current-limiting circuitry, enabling them to pass FCC 68.302 and other regulatory surge requirements when overvoltage protection is provided.

Order Information

Part	Remarks
LH1533AAC	SMD-8, Tubes
LH1533AACTR	SMD-8, Tape and Reel
LH1533AB	DIP-8, Tubes

Absolute Maximum Ratings, T_{amb} = 25 °C

Stresses in excess of the absolute Maximum Ratings can cause permanent damage to the device. Functional operation of the device is not implied at these or any other conditions in excess of those given in the operational sections of this document. Exposure to absolute Maximum Ratings for extended periods of time can adversely affect reliability.

SSR

Parameter	Test condition	Symbol	Value	Unit
LED continuous forward current		I _F	50	mA
LED reverse voltage	I _R ≤ 10 μA	V _R	5.0	V
Output operation: dc or peak ac load voltage	I _L ≤ 50 μA	V _L	350	V

Parameter	Test condition	Symbol	Value	Unit
Continuous dc load current: one pole operating		I_L	90	mA
Continuous dc load current: two pole operating		I_L	70	mA
Ambient operating temperature range		T_{amb}	- 40 to + 85	°C
Storage temperature range		T_{stg}	- 55 to + 150	°C
Pin soldering temperature	$t = 10.0$ s max	T_{sld}	260	°C
Input/output isolation voltage		V_{ISO}	5300	V_{RMS}
Power dissipation (continuous)		P_{diss}	600	mW

Electrical Characteristics, $T_{amb} = 25$ °C

Minimum and maximum values are testing requirements. Typical values are characteristics of the device and are the result of engineering evaluations. Typical values are for information only and are not part of the testing requirements.

Input

Parameter	Test condition	Symbol	Min	Typ.	Max	Unit
LED forward current, switch turn-on	$I_L = 100$ mA, $t = 10$ ms	I_{Fon}			2.5	mA
LED forward current, switch turn-off	$V_L = \pm 300$ V	I_{Foff}	0.01	1.1		mA
LED forward voltage	$I_F = 5.0$ mA	V_F	0.9	1.2	1.4	V

Output

Parameter	Test condition	Symbol	Min	Typ.	Max	Unit
ON-resistance	$I_F = 5.0$ mA, $I_L = \pm 90$ mA	R_{ON}	25	28	50	Ω
Current limit	$I_F = 5.0$ mA, $t = 5.0$ ms, $V_L = 13$ V	I_{LMT}	150	200	270	mA
Off-state leakage current	$I_F = 0$ mA, $V_L = \pm 350$ V				1.0	nA

Transfer

Parameter	Test condition	Symbol	Min	Typ.	Max	Unit
Turn-on time	$I_F = 5.0$ mA, $I_L = 50$ mA	t_{on}			3.0	ms
Turn-off time	$I_F = 5.0$ mA, $I_L = 50$ mA	t_{off}			3.0	ms

Typical Characteristics ($T_{amb} = 25\text{ }^{\circ}\text{C}$ unless otherwise specified)

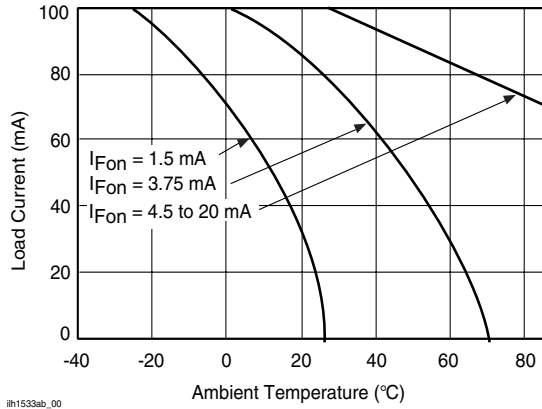

ih1533ab_00

Figure 1. Recommended Operating Conditions

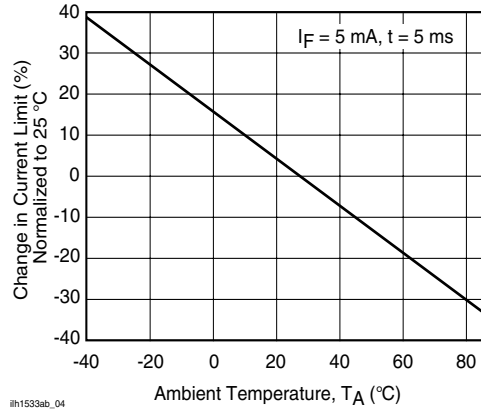

ih1533ab_04

Figure 4. Current Limit vs. Temperature

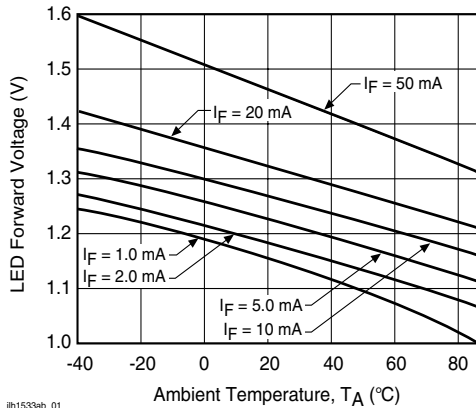

ih1533ab_01

Figure 2. LED Voltage vs. Temperature

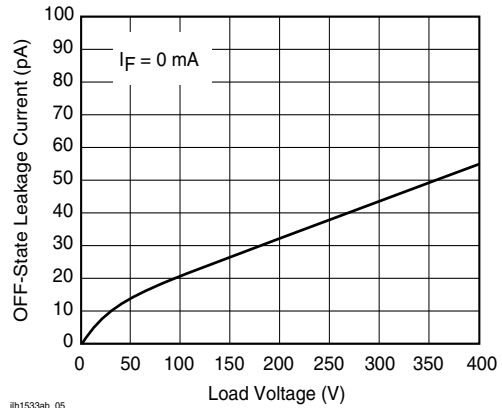

ih1533ab_05

Figure 5. Leakage Current vs. Applied Voltage

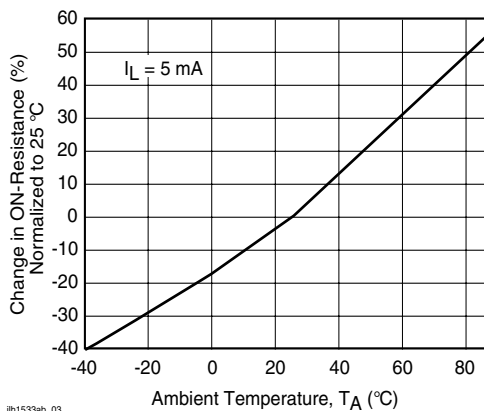

ih1533ab_03

Figure 3. ON-Resistance vs. Temperature

LH1533AB/ AAC/ AACTR



Vishay Semiconductors

Package Dimensions in Inches (mm)

DIP

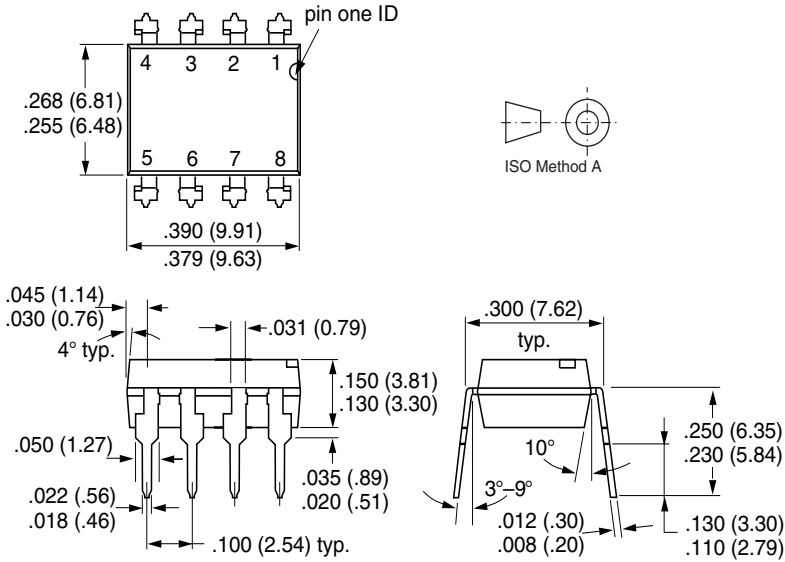

i178008

SMD

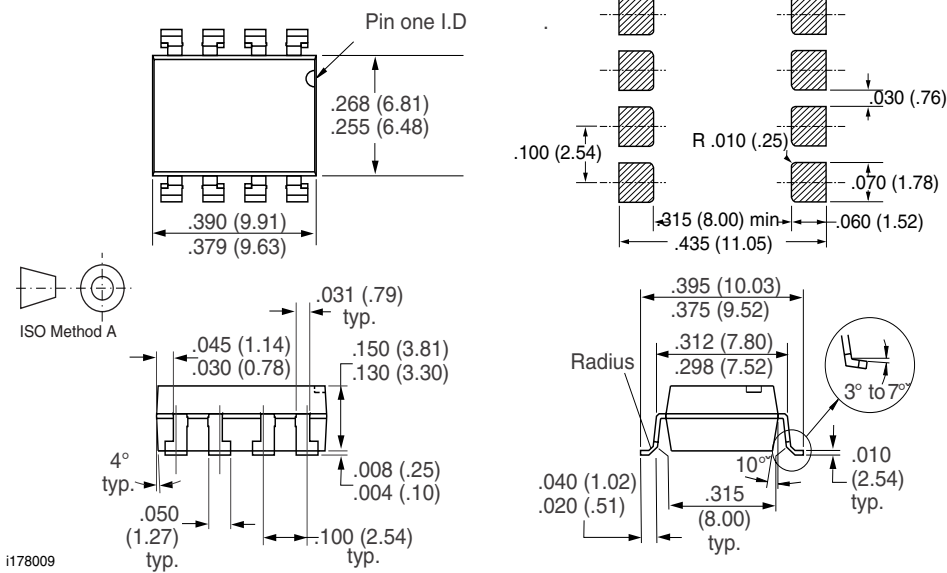

i178009



Ozone Depleting Substances Policy Statement

It is the policy of **Vishay Semiconductor GmbH** to

1. Meet all present and future national and international statutory requirements.
2. Regularly and continuously improve the performance of our products, processes, distribution and operating systems with respect to their impact on the health and safety of our employees and the public, as well as their impact on the environment.

It is particular concern to control or eliminate releases of those substances into the atmosphere which are known as ozone depleting substances (ODSs).

The Montreal Protocol (1987) and its London Amendments (1990) intend to severely restrict the use of ODSs and forbid their use within the next ten years. Various national and international initiatives are pressing for an earlier ban on these substances.

Vishay Semiconductor GmbH has been able to use its policy of continuous improvements to eliminate the use of ODSs listed in the following documents.

1. Annex A, B and list of transitional substances of the Montreal Protocol and the London Amendments respectively
2. Class I and II ozone depleting substances in the Clean Air Act Amendments of 1990 by the Environmental Protection Agency (EPA) in the USA
3. Council Decision 88/540/EEC and 91/690/EEC Annex A, B and C (transitional substances) respectively.

Vishay Semiconductor GmbH can certify that our semiconductors are not manufactured with ozone depleting substances and do not contain such substances.

**We reserve the right to make changes to improve technical design
and may do so without further notice.**

Parameters can vary in different applications. All operating parameters must be validated for each customer application by the customer. Should the buyer use Vishay Semiconductors products for any unintended or unauthorized application, the buyer shall indemnify Vishay Semiconductors against all claims, costs, damages, and expenses, arising out of, directly or indirectly, any claim of personal damage, injury or death associated with such unintended or unauthorized use.

Vishay Semiconductor GmbH, P.O.B. 3535, D-74025 Heilbronn, Germany
Telephone: 49 (0)7131 67 2831, Fax number: 49 (0)7131 67 2423

This datasheet has been download from:

www.datasheetcatalog.com

Datasheets for electronics components.