



HAOPIN MICROELECTRONICS CO.,LTD.

Description

Passivated high commutation triacs in a plastic envelope intended for use in circuits where high static and dynamic dV/dt and high dI/dt can occur. These devices will commutate the full rated ms current at the maximum rated junction temperature without the aid of a snubber.

<p>Symbol</p> 		<p>Simplified outline</p> 	
Pin	Description		
1	Main terminal 1 (T1)		
2	Main terminal 2 (T2)		
3	gate (G)		
TAB	isolated		

Applications:

- ◆ Motor control
- ◆ Industrial and domestic lighting
- ◆ Heating
- ◆ Static switching

Features

- ◆ Blocking voltage to 600 V
- ◆ On-state RMS current to 6 A

SYMBOL	PARAMETER	Value	Unit
V_{DRM}	Repetitive peak off-state voltages	600	V
$I_T (RMS)$	RMS on-state current (full sine wave)	6	A
I_{TSM}	Non-repetitive peak on-state current (full cycle, T_j initial=25°C)	63	A

SYMBOL	PARAMETER	CONDITIONS	MIN	TYP	MAX	UNIT
$R_{th(j-c)}$	Junction to case(AC)		-	2.7	-	°C/W
$R_{th(j-a)}$	Junction to ambient		-	60	-	°C/W

HAOPIN MICROELECTRONICS CO.,LTD.

Limiting values in accordance with the Maximum system(IEC 134)

SYMBOL	PARAMETER	CONDITIONS		MIN	Value	UNIT
V_{DRM}	Repetitive peak off-state Voltages			-	600	V
$I_{T(RMS)}$	RMS on-state current	Full sine wave; $T_c \leq 105^\circ\text{C}$		-	6	A
I_{TSM}	Non repetitive surge peak on-state current	full cycle, T_j initial= 25°C	F=50Hz t=20ms	-	60	A
			F=60Hz t=16.7ms	-	63	A
I^2t	I^2t Value for fusing	$T_p=10\text{ms}$		-	21	A^2S
DI/dt	Critical rate of rise of on-state current	$I_G=2 \times I_{GT}, tr \leq 100\text{ns}$	F=120Hz $T_j=125^\circ\text{C}$	-	50	$\text{A}/\mu\text{s}$
I_{GM}	Peak gate current		tp=20us $T_j=125^\circ\text{C}$	-	4	A
I_{DRM}	$V_{DRM}=V_{RRM}$		$T_j=25^\circ\text{C}$	-	5	μA
I_{RRM}	$V_{DRM}=V_{RRM}$		$T_j=125^\circ\text{C}$	-	1	mA
$P_{G(AV)}$	Average gate power		$T_j=125^\circ\text{C}$	-	1	W
T_{stg}	Storage temperature range			-40	150	$^\circ\text{C}$
T_j	Operating junction Temperature range			-40	125	$^\circ\text{C}$

$T_j=25^\circ\text{C}$ unless otherwise stated

SYMBOL	PARAMETER	CONDITIONS	MIN	TYP	MAX	UNIT
Static characteristics						
I_{GT1}	V_{GT}	$V_D=12\text{V}; R_L=30\Omega$	I-II-III	-	-	10
						I-II-III
I_L	Latching current	$I_G=1.2 I_{GT}$	I-III	-	-	25
			II	-	-	30
I_H		$I_T=100\text{mA}$		-	-	15
V_{GD}		$V_D=V_{DRM} R_L=3.3\text{K}\Omega T_j=125^\circ\text{C}$	I-II-III	0.2	-	-
$dV/dt2$		$V_D=67\%V_{DRM}$ gate open; $T_j=125^\circ\text{C}$		40	-	-
(Dv/dt)c(2)		(dV/dt)c=0.1V/ μs $T_j=125^\circ\text{C}$ (dV/dt) c=10V/ μs $T_j=125^\circ\text{C}$		3.5	-	-
				2.4	-	-

Dynamic Characteristics

$V_T(2)$	$I_{TM}=5.5\text{A}$ tp=380 μs	$T_j=25^\circ\text{C}$	-	-	1.55	V
V_{to}	Threshold voltage	$T_j=125^\circ\text{C}$	-	-	0.85	V
R_d	Dynamic resistance	$T_j=125^\circ\text{C}$	-	-	60	$\text{m}\Omega$

Description

Fig. 1: Maximum power dissipation versus RMS on-state current (full cycle).

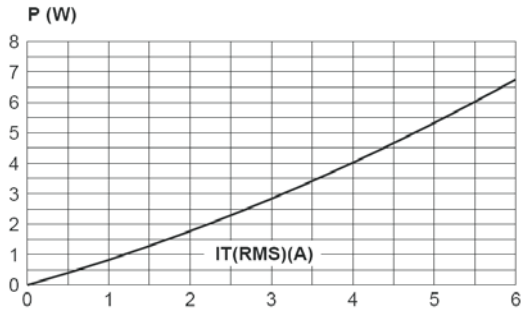

Fig. 2: RMS on-state current versus case temperature (full cycle).

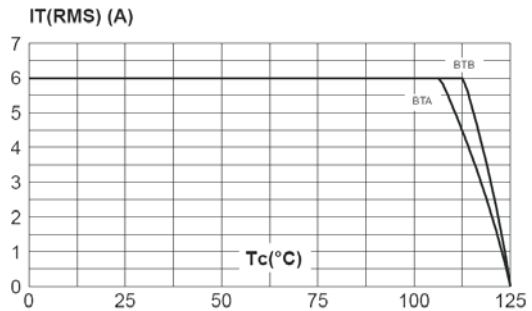

Fig. 3: Relative variation of thermal impedance versus pulse duration.

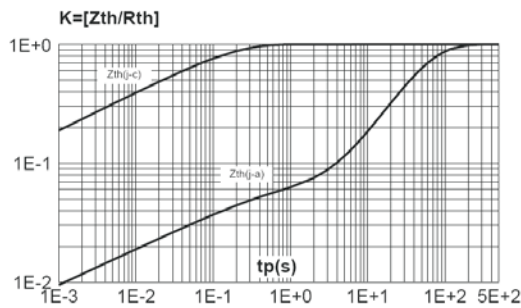

Fig. 4: On-state characteristics (maximum values).

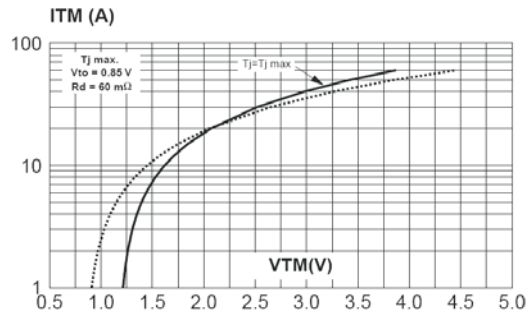

Fig. 5: Surge peak on-state current versus number of cycles.

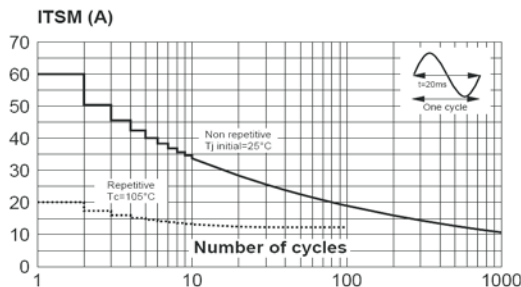
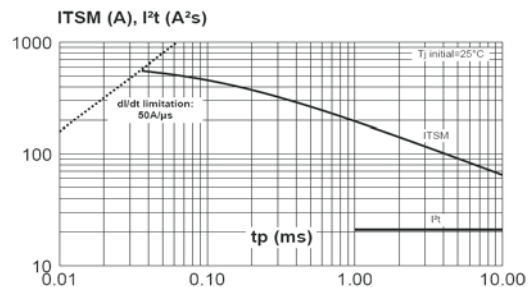

Fig. 6: Non-repetitive surge peak on-state current for a sinusoidal pulse with width tp < 10ms, and corresponding value of I²t.



Description

Fig. 7: Relative variation of gate trigger current, holding current and latching current versus junction temperature (typical values).

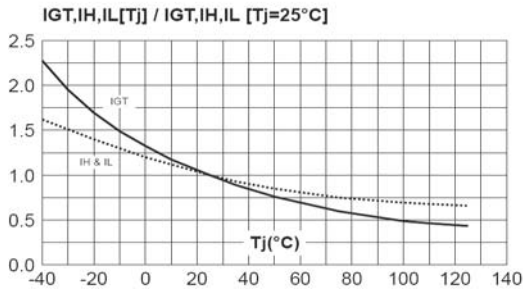

Fig. 8-1: Relative variation of critical rate of decrease of main current versus (dV/dt)c (typical values). Snubberless & Logic Level Types

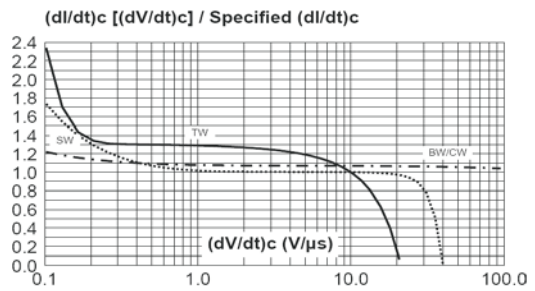

Fig. 8-2: Relative variation of critical rate of decrease of main current versus (dV/dt)c (typical values). Standard Types

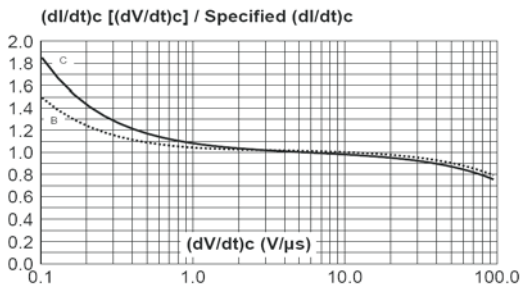
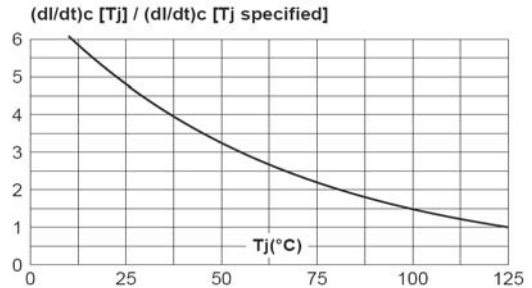
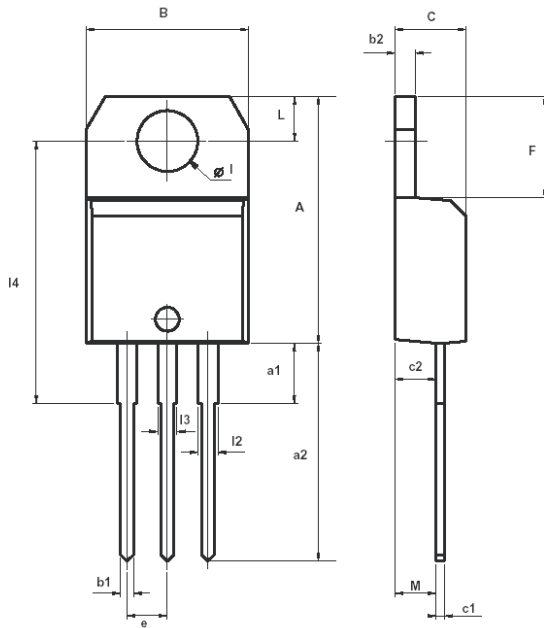

Fig. 9: Relative variation of critical rate of decrease of main current versus junction temperature.



MECHANICAL DATA

Dimensions in mm
Net Mass: 2 g



REF.	DIMENSIONS					
	Millimeters			Inches		
	Min.	Typ.	Max.	Min.	Typ.	Max.
A	15.20		15.90	0.598		0.625
a1		3.75			0.147	
a2	13.00		14.00	0.511		0.551
B	10.00		10.40	0.393		0.409
b1	0.61		0.88	0.024		0.034
b2	1.23		1.32	0.048		0.051
C	4.40		4.60	0.173		0.181
c1	0.49		0.70	0.019		0.027
c2	2.40		2.72	0.094		0.107
e	2.40		2.70	0.094		0.106
F	6.20		6.60	0.244		0.259
l	3.75		3.85	0.147		0.151
i4	15.80	16.40	16.80	0.622	0.646	0.661
L	2.65		2.95	0.104		0.116
i2	1.14		1.70	0.044		0.066
i3	1.14		1.70	0.044		0.066
M		2.60			0.102	