

MITSUBISHI IGBT Module

MG600Q2YS60A

High Power Switching Applications

Motor Control Applications

- The electrodes are isolated from case.
- Enhancement-mode
- Thermal output terminal (TH)

Equivalent Circuit

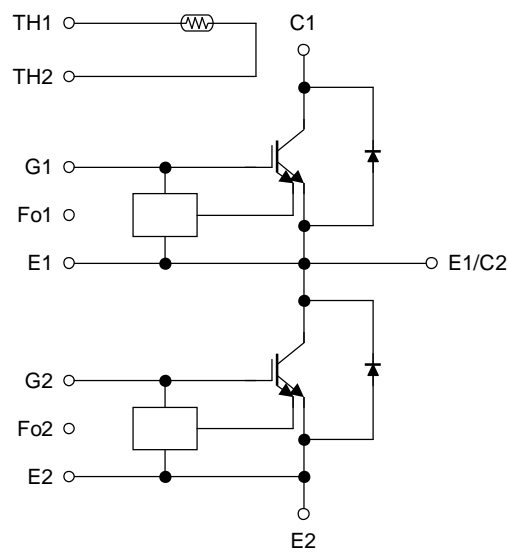

Maximum Ratings (Ta = 25°C)

Characteristic		Symbol	Rating	Unit
Collector-emitter voltage		V _{CES}	1200	V
Gate-emitter voltage		V _{GES}	±20	V
Collector current	DC	I _C	600	A
Forward current	DC	I _F	600	A
Collector power dissipation (T _c = 25°C)		P _C	4300	W
Junction temperature		T _j	150	°C
Storage temperature range		T _{stg}	-40~125	°C
Isolation voltage		V _{Isol}	2500 (AC 1 min)	V
Screw torque	Terminal: M8	—	10	N·m
	Mounting: M5	—	3	N·m

Electrical Characteristics (Ta = 25°C)

Characteristic		Symbol	Test Condition	Min.	Typ.	Max.	Unit	
Gate leakage current		I _{GES}	V _{GE} = ±20V, V _{CE} = 0V	—	—	±10	μA	
Collector cut-off current		I _{CES}	V _{CE} = 1200V, V _{GE} = 0	—	—	1	mA	
Gate-emitter cut-off voltage		V _{GE(off)}	I _C = 600mA, V _{CE} = 5V	6.0	6.7	8.0	V	
Collector-emitter saturation voltage		V _{CES(sat)}	I _C = 600A V _{GE} = 15V	T _j = 25°C	—	2.7	3.1	V
				T _j = 125°C	—	3.2	3.5	
Input capacitance		C _{ies}	V _{CE} = 10V, V _{GE} = 0V, f = 1MHz	—	41000	—	pF	
Gate-emitter voltage		V _{GE}	—	13	15	17	V	
Gate resistance		R _G	—	7.5	—	15	Ω	
Switching time	Turn-on delay time	t _{d(on)}	Inductive load V _{CC} = 600V I _C = 600A V _{GE} = ±15V R _G = 7.5Ω (Note)	—	0.3	—	μs	
	Rise time	t _r		—	0.2	—		
	Turn-on time	t _{on}		—	0.5	—		
	Turn-off delay time	t _{d(off)}		—	1.3	—		
	Fall time	t _f		—	0.1	0.3		
	Turn-off time	t _{off}		—	1.4	—		
Forward voltage		V _F	I _F = 600A, V _{GE} = 0V	T _j = 25°C	—	2.2	3.2	V
				T _j = 125°C	—	2.0	—	
Reverse recovery time		t _{rr}	I _F = 600A, V _{GE} = -15V di / dt = 2000A / μs	—	0.3	0.5	μs	
Thermal resistance		R _{th(j-c)}	Transistor stage	—	—	0.029	°C / W	
			Diode stage	—	—	0.056		
RTC operating current		I _{rtc}	T _j = 25°C	1200	—	—	A	

Thermistor

Characteristic	Symbol	Test Condition	Min.	Typ.	Max.	Unit
Zero power resistance	R25	$T_c = 25^\circ\text{C}$	—	100	—	$\text{k}\Omega$
B value	B25 / 85	$T_c = 25^\circ\text{C} / T_c = 85^\circ\text{C}$	—	4390	—	K
Isolation voltage		$T_c = 25^\circ\text{C}$	2500	—	—	Vrms

(Note): Switching time measurement circuit and input / output waveforms

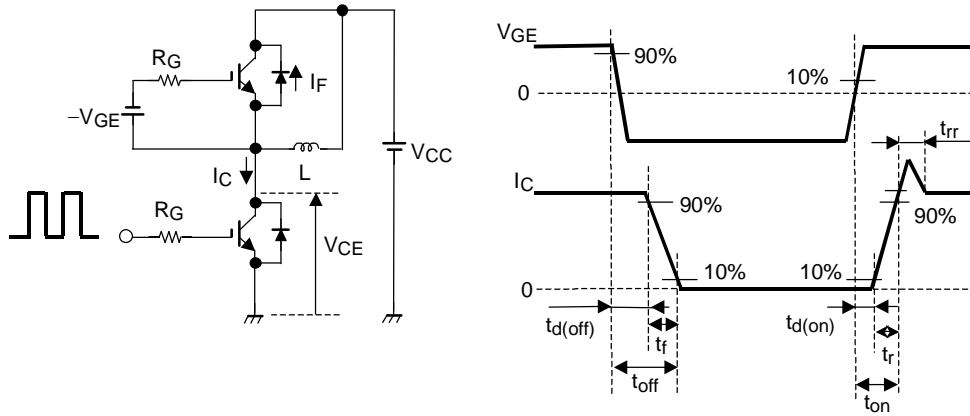

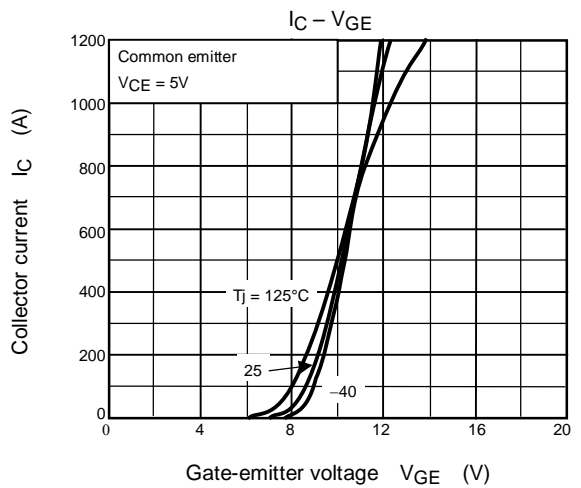
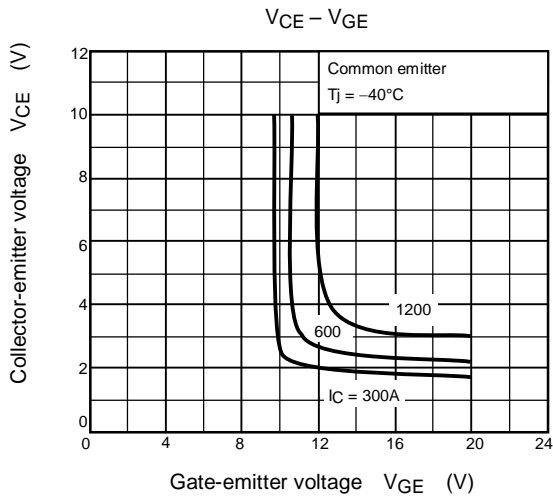
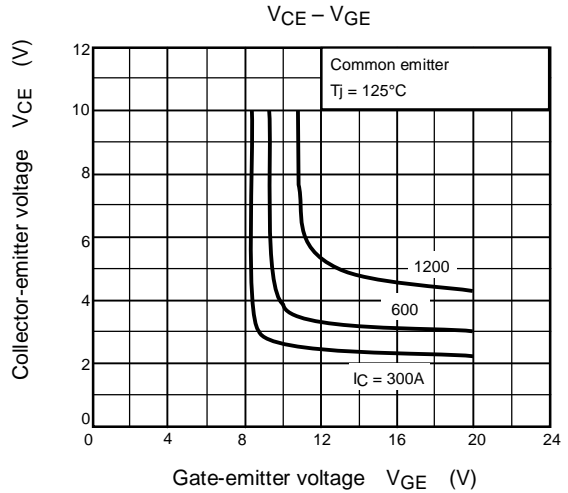
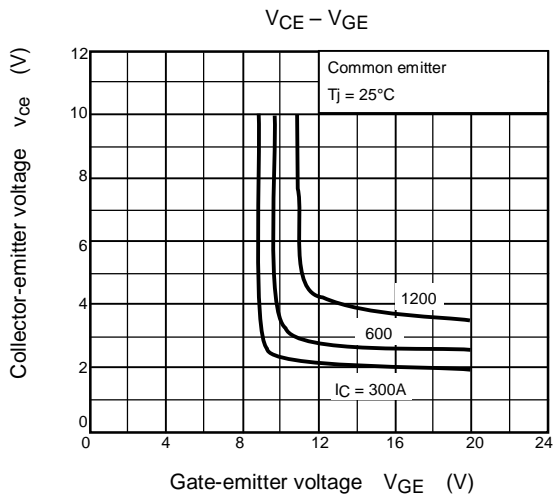
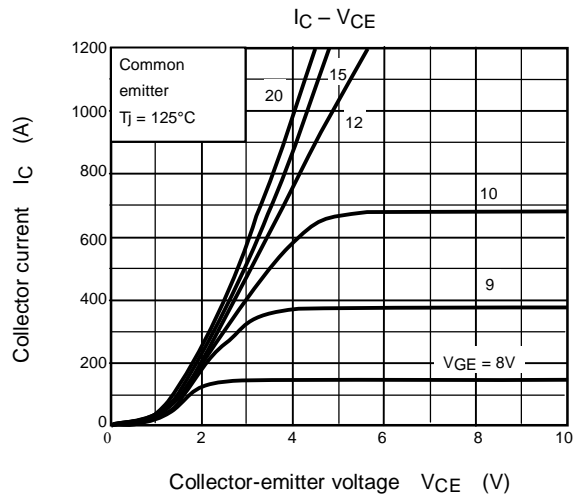
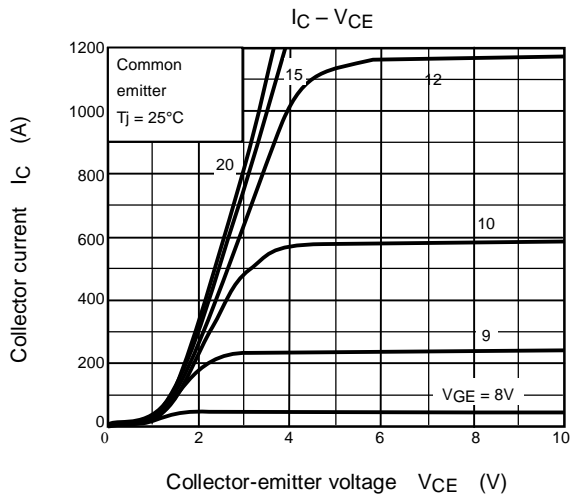

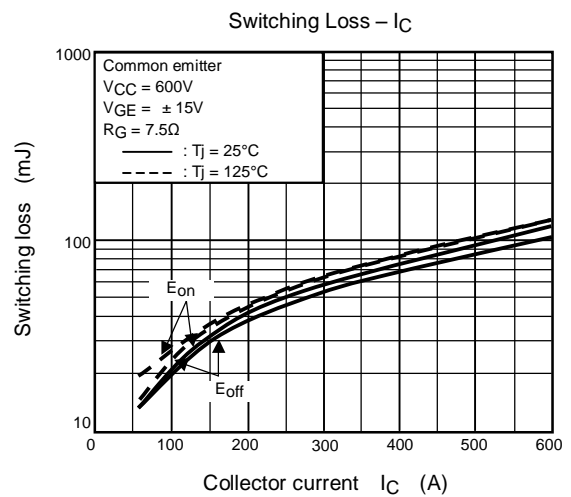
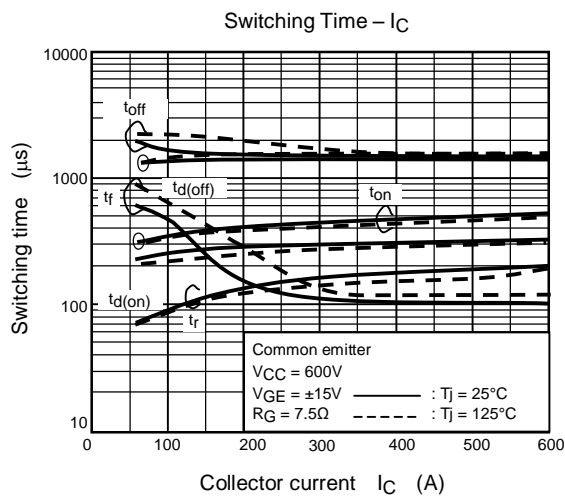
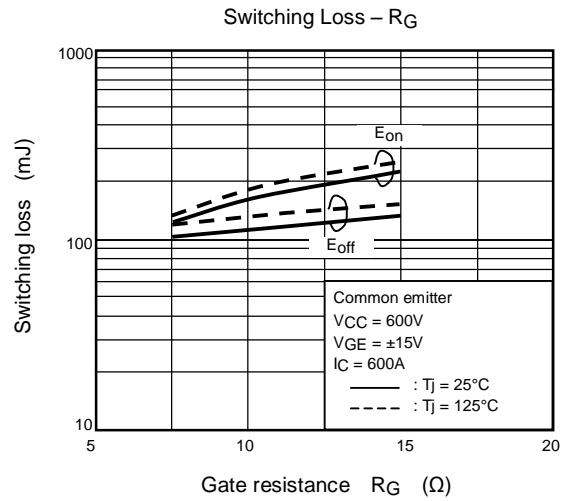
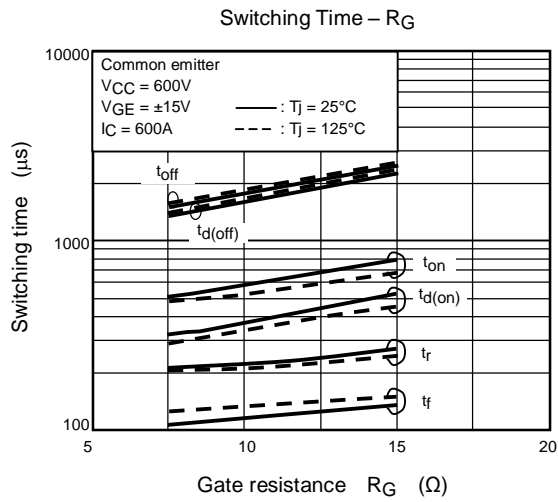
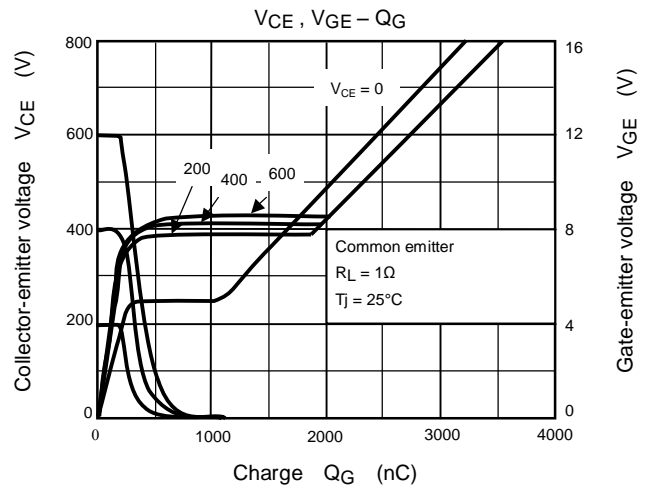
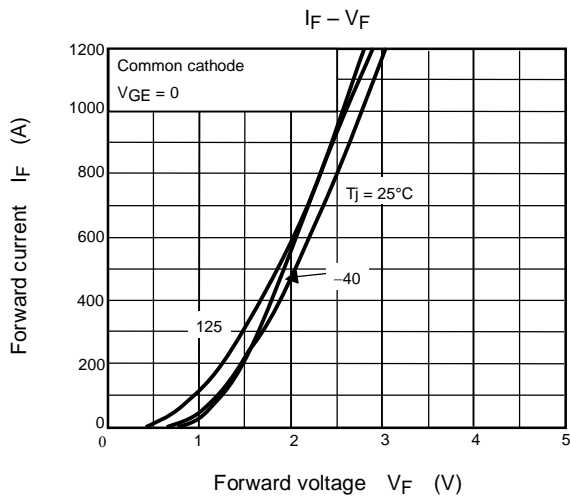

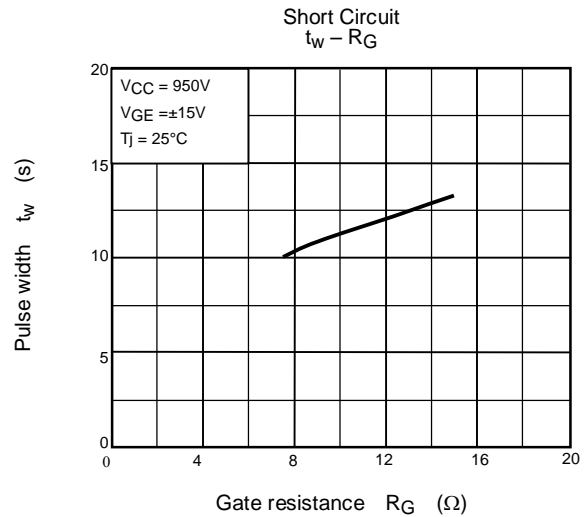
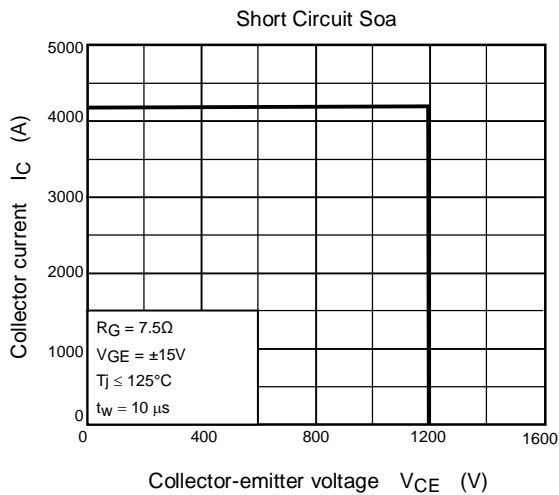
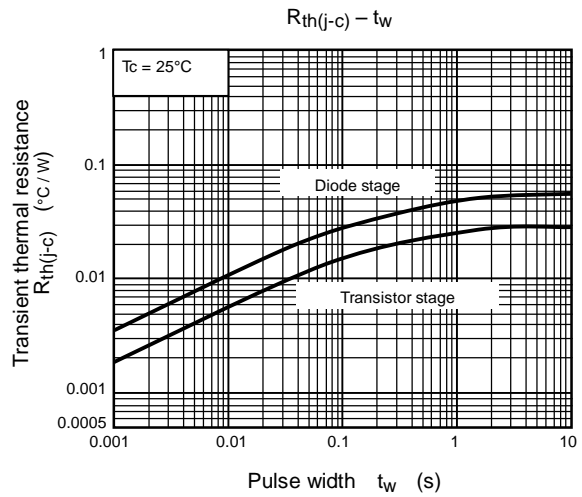
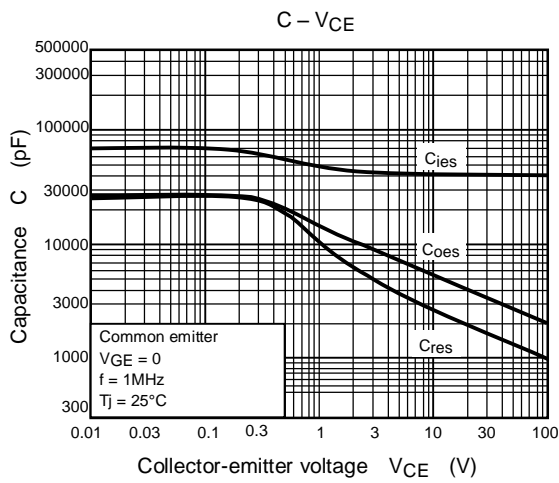
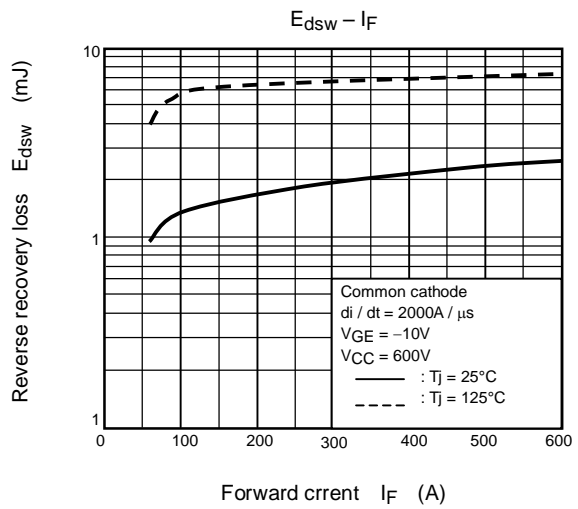
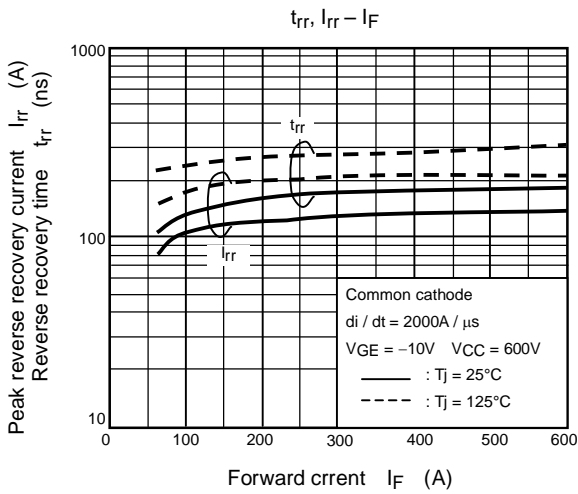

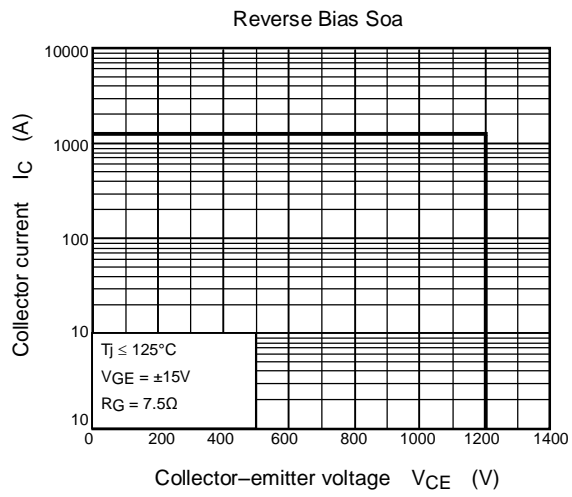

<V_{CE(sat)} Rank>

V_{CE(sat)}

Rank Symbol	Min.	Max.
21	1.8	2.1
22	1.9	2.2
23	2.0	2.3
24	2.1	2.4
25	2.2	2.5
26	2.3	2.6
27	2.4	2.7
28	2.5	2.8
29	2.6	2.9
30	2.7	3.0
31	2.8	3.1
32	2.9	3.2
33	3.0	3.3

<V_F Rank>

V_F

Rank Symbol	Min.	Max.
B	1.5	1.8
C	1.7	2.0
D	1.9	2.2
E	2.1	2.4
F	2.3	2.6
G	2.5	2.8
H	2.7	3.0
I	2.9	3.2
J	3.1	3.4
K	3.3	3.6

<Mark Position>

