

**GPP TRANSIENT VOLTAGE SUPPRESSOR
1500 WATT PEAK POWER 1.0 WATT STEADY STATE**

FEATURES

- * Plastic package has underwriters laboratory
- * Glass passivated chip construction
- * 1500 watt surge capability at 1ms
- * Excellent clamping capability
- * Low zener impedance
- * Fast response time
- * AEC-Q101 certified (-AA1)

Ratings at 25 °C ambient temperature unless otherwise specified.

MAXIMUM RATINGS AND ELECTRICAL CHARACTERISTICS

Ratings at 25 °C ambient temperature unless otherwise specified.



DO-214AB

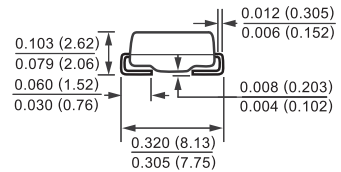
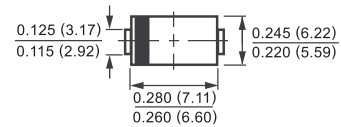

Dimensions in inches and (millimeters)

DEVICES FOR BIPOLAR APPLICATIONS

For Bidirectional use C or CA suffix for types TFMCJ5.0 thru TFMCJ170

Electrical characteristics apply in both direction

MAXIMUM RATINGS (At TA = 25°C unless otherwise noted)

RATINGS	SYMBOL	VALUE	UNITS
Peak Power Dissipation with a 10/1000uS (Note 1,2, Fig.1)	PPPM	Minimum 1500	Watts
Peak Pulse Current with a 10/1000uS waveform (Note 1, Fig.3)	IPPM	SEE TABLE 1	Amps
Steady State Power Dissipation at TL = 75°C (Note 2)	PM(AV)	5.0	Watts
Peak Forward Surge Current 8.3mS single half sine-wave superimposed on rated load (JEDEC method) (Note 2,3) unidirectional only	IFSM	100	Amps
Typical Current Squared Time	I ² t	41.5	A ² /Sec
Maximum Instantaneous Forward Voltage at 100A for unidirectional only (Note 3,4)	V _F	SEE NOTE 3,4	Volts
Operating and Storage Temperature Range	T _J , T _{STG}	-55 to + 150	°C

- NOTES : 1. Non-repetitive current pulse, per Fig.3 and derated above TA = 25°C per Fig.2.
 2. Mounted on 0.31 X 0.31" (8.0 X 8.0mm) copper pad to each terminal.
 3. Lead temperature at TL = 25°C
 4. Measured on 8.3mS single half sine-wave duty cycle = 4 pulses per minute maximum.
 5. V_F = 3.5V on TFMCJ-5.0 thru TFMCJ-90 devices and V_F = 5.0V on TFMCJ-100 thru TFMCJ-170 devices.

RATING AND CHARACTERISTIC CURVES (TFMCJ5.0 THRU TFMCJ170CA)

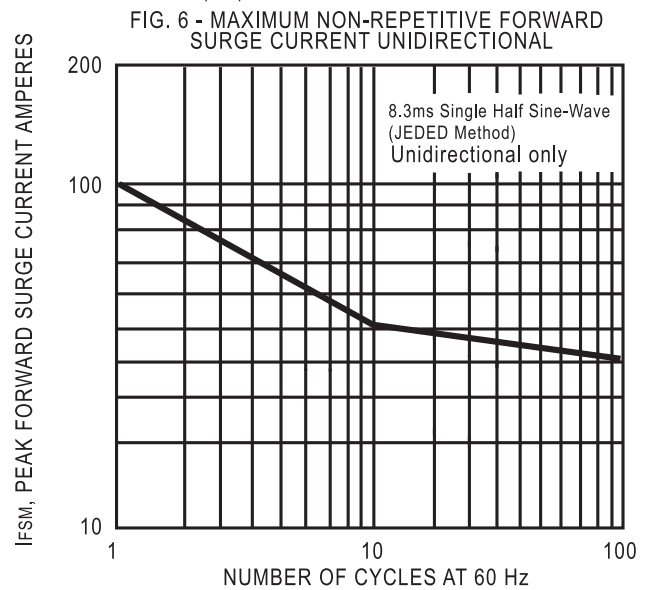
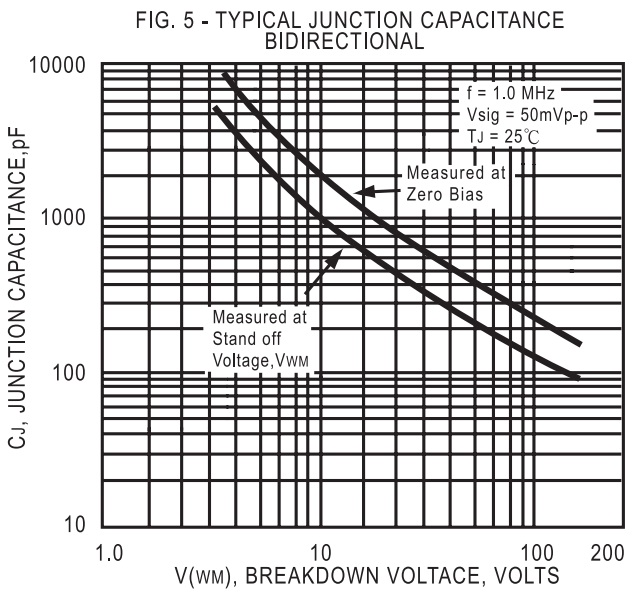
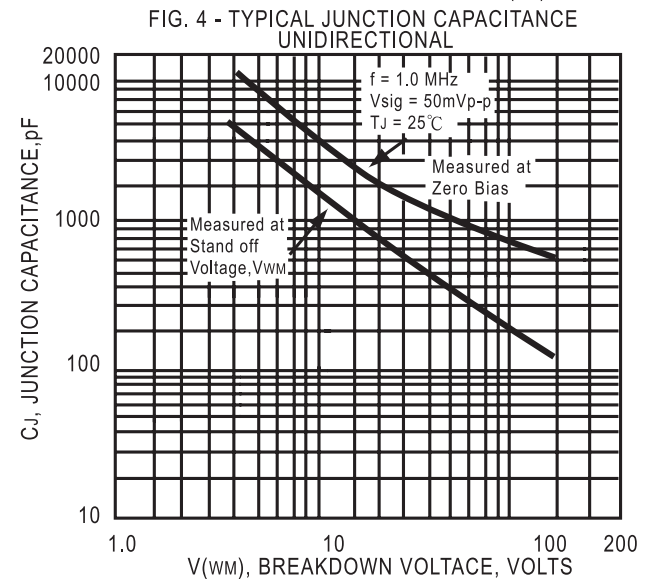
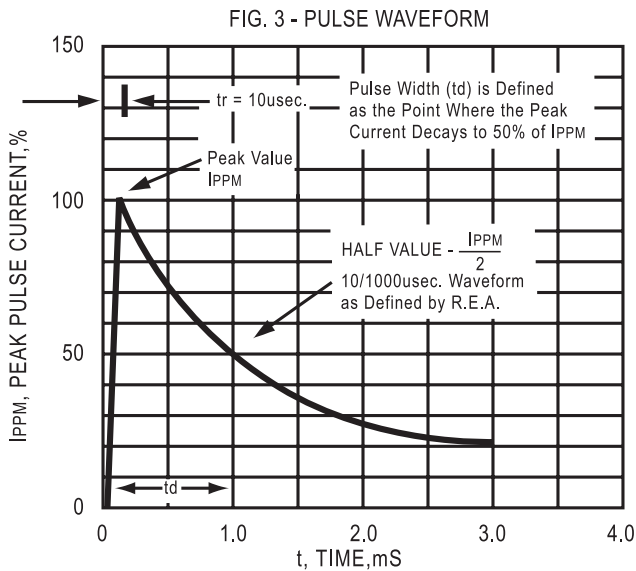
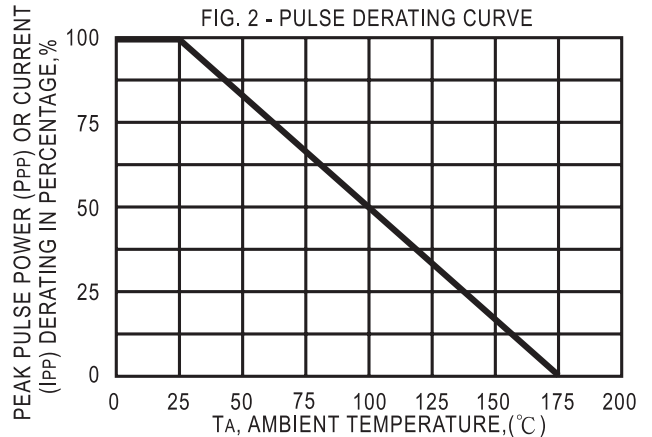
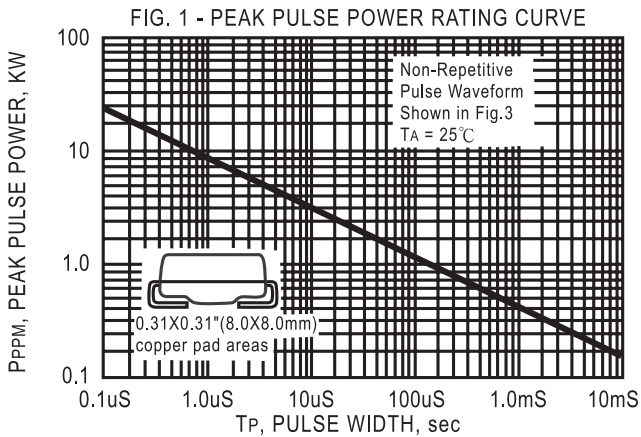

TRANSIENT VOLTAGE SUPPRESSORS

1500W SERIES TVS DIODES / DO-214AB (CASE 4) 1500W

TYPE	Breakdown Voltage		@IT (mA)	Reverse Stand off Voltage VWM (Volts)	Maximum Reverse Leakage at VWM ID(uA)	Maximum Peak Pulse Current IPPM (Amps)	Maximum Clamping Voltage at IPPM Vc (Volts)
	VBR (Volts)						
	MIN.	MAX.					
TFMCJ5.0	6.40	7.30	10	5.0	1000	164.0	9.6
TFMCJ5.0A	6.40	7.00	10	5.0	1000	171.0	9.2
TFMCJ6.0	6.67	8.15	10	6.0	1000	138.0	11.4
TFMCJ6.0A	6.67	7.37	10	6.0	1000	152.0	10.3
TFMCJ6.5	7.22	8.82	10	6.5	500.0	128.0	12.3
TFMCJ6.5A	7.22	7.98	10	6.5	500.0	140.0	11.2
TFMCJ7.0	7.78	9.51	10	7.0	200.0	118.0	13.3
TFMCJ7.0A	7.78	8.86	10	7.0	200.0	131.0	12.0
TFMCJ7.5	8.33	10.2	1.0	7.5	100.0	110.0	14.3
TFMCJ7.5A	8.33	9.21	1.0	7.5	100.0	122.0	12.9
TFMCJ8.0	8.89	10.9	1.0	8.0	50.0	105.0	15.0
TFMCJ8.0A	8.89	9.83	1.0	8.0	50.0	115.0	13.6
TFMCJ8.5	9.44	11.5	1.0	8.5	25	99.0	15.9
TFMCJ8.5A	9.44	10.4	1.0	8.5	25	109.0	14.4
TFMCJ9.0	10.0	12.2	1.0	9.0	10	93.0	16.9
TFMCJ9.0A	10.0	15.0	1.0	9.0	10	102.0	15.4
TFMCJ10	11.1	13.6	1.0	10.0	5.0	83.0	18.8
TFMCJ10A	11.1	12.3	1.0	10.0	5.0	92.0	17.0
TFMCJ11	12.2	14.9	1.0	11.0	5.0	78.0	20.1
TFMCJ11A	12.2	13.5	1.0	11.0	5.0	86.0	18.2
TFMCJ12	13.3	16.3	1.0	12.0	5.0	71.0	22.0
TFMCJ12A	13.3	14.7	1.0	12.0	5.0	79.0	19.9
TFMCJ13	14.4	17.6	1.0	13.0	5.0	66.0	23.8
TFMCJ13A	14.4	15.9	1.0	13.0	5.0	73.0	21.5
TFMCJ14	15.6	19.1	1.0	14.0	5.0	61.0	25.8
TFMCJ14A	15.6	17.2	1.0	14.0	5.0	67.0	23.2
TFMCJ15	16.7	20.4	1.0	15.0	5.0	58.0	26.9
TFMCJ15A	16.7	18.5	1.0	15.0	5.0	64.0	24.4
TFMCJ16	17.8	21.8	1.0	16.0	5.0	54.0	28.8
TFMCJ16A	17.8	19.7	1.0	16.0	5.0	60.0	26.0
TFMCJ17	18.9	23.1	1.0	17.0	5.0	51.0	30.5
TFMCJ17A	18.9	20.9	1.0	17.0	5.0	57.0	27.6
TFMCJ18	20.0	24.2	1.0	18.0	5.0	48.0	32.2
TFMCJ18A	20.0	22.1	1.0	18.0	5.0	53.0	29.2
TFMCJ20	22.2	27.1	1.0	20.0	5.0	43.0	35.8
TFMCJ20A	22.2	24.5	1.0	20.0	5.0	48.0	32.4
TFMCJ22	24.4	29.8	1.0	22.0	5.0	39.0	39.4
TFMCJ22A	24.4	26.9	1.0	22.0	5.0	44.0	35.5
TFMCJ24	26.7	32.6	1.0	24.0	5.0	36.0	43.0
TFMCJ24A	26.7	29.5	1.0	24.0	5.0	40.0	38.9
TFMCJ26	28.9	35.3	1.0	26.0	5.0	33.0	46.6
TFMCJ26A	28.9	31.9	1.0	26.0	5.0	37.0	42.1
TFMCJ28	31.1	38.0	1.0	28.0	5.0	31.0	50.1
TFMCJ28A	31.1	34.4	1.0	28.0	5.0	34.0	45.4
TFMCJ30	33.3	40.7	1.0	30.0	5.0	29.0	53.5
TFMCJ30A	33.3	36.8	1.0	30.0	5.0	32.0	48.4
TFMCJ33	36.7	44.9	1.0	33.0	5.0	26.0	59.0
TFMCJ33A	36.7	40.6	1.0	33.0	5.0	29.0	53.3
TFMCJ36	40.0	48.9	1.0	36.0	5.0	24.0	64.3
TFMCJ36A	40.0	44.2	1.0	36.0	5.0	27.0	58.1

TRANSIENT VOLTAGE SUPPRESSORS

1500W SERIES TVS DIODES / DO-214AB (CASE 4) 1500W

TYPE	Breakdown Voltage		@I _T (mA)	Reverse Stand off Voltage V _{WM} (Volts)	Maximum Reverse Leakage at V _{WM} I _D (uA)	Maximum Peak Pulse Current IPPM (Amps)	Maximum Clamping Voltage at IPPM V _c (Volts)
	V _{BR} (Volts)						
	MIN.	MAX.					
TFMCJ40	44.4	54.3	1.0	40	5.0	22.0	71.4
TFMCJ40A	44.4	49.1	1.0	40	5.0	24.0	64.5
TFMCJ43	47.8	58.4	1.0	43	5.0	20.0	76.7
TFMCJ43A	47.8	52.8	1.0	43	5.0	22.0	69.4
TFMCJ45	50.0	61.1	1.0	45	5.0	19.0	80.3
TFMCJ45A	50.0	55.3	1.0	45	5.0	21.0	72.7
TFMCJ48	53.3	65.1	1.0	48	5.0	18.0	85.5
TFMCJ48A	53.3	58.9	1.0	48	5.0	20.0	77.4
TFMCJ51	56.7	69.3	1.0	51	5.0	17.0	91.1
TFMCJ51A	56.7	62.7	1.0	51	5.0	19.0	82.4
TFMCJ54	60.0	73.3	1.0	54	5.0	16.0	96.3
TFMCJ54A	60.0	66.3	1.0	54	5.0	18.0	87.1
TFMCJ58	64.4	78.7	1.0	58	5.0	15.0	103
TFMCJ58A	64.4	71.2	1.0	58	5.0	16.0	93.6
TFMCJ60	66.7	81.5	1.0	60	5.0	14.0	107
TFMCJ60A	66.7	73.7	1.0	60	5.0	16.0	96.8
TFMCJ64	71.1	86.9	1.0	64	5.0	13.8	114
TFMCJ64A	71.1	78.6	1.0	64	5.0	15.0	103
TFMCJ70	77.8	95.1	1.0	70	5.0	12.6	125
TFMCJ70A	77.8	86.0	1.0	70	5.0	13.9	113
TFMCJ75	83.3	102	1.0	75	5.0	11.7	134
TFMCJ75A	83.3	92.1	1.0	75	5.0	13.0	121
TFMCJ78	86.7	106	1.0	78	5.0	11.3	139
TFMCJ78A	86.7	95.8	1.0	78	5.0	12.5	126
TFMCJ85	94.4	115	1.0	85	5.0	10.4	151
TFMCJ85A	94.4	104	1.0	85	5.0	11.5	137
TFMCJ90	100	122	1.0	90	5.0	9.8	160
TFMCJ90A	100	111	1.0	90	5.0	10.7	146
TFMCJ100	110	136	1.0	100	5.0	8.8	179
TFMCJ100A	110	123	1.0	100	5.0	9.7	162
TFMCJ110	122	149	1.0	110	5.0	8.0	196
TFMCJ110A	122	135	1.0	110	5.0	8.9	177
TFMCJ120	133	163	1.0	120	5.0	7.3	214
TFMCJ120A	133	147	1.0	120	5.0	8.1	193
TFMCJ130	144	176	1.0	130	5.0	6.8	231
TFMCJ130A	144	159	1.0	130	5.0	7.5	209
TFMCJ150	167	204	1.0	150	5.0	5.8	268
TFMCJ150A	167	185	1.0	150	5.0	6.4	243
TFMCJ160	178	218	1.0	160	5.0	5.4	287
TFMCJ160A	178	197	1.0	160	5.0	6.0	259
TFMCJ170	189	231	1.0	170	5.0	5.1	304
TFMCJ170A	189	209	1.0	170	5.0	5.7	275

- NOTES : 1. V_{BR} measured after I_T applied for 300ms. I_T = square pluse or equivalent.
 2. For bidirectional use C or CA suffixs for all types (ex. TFMCJ5.0C,TFMCJ170CA) electrical characteristics apply in both directions.
 3. For bidirectional types having V_{WM} of 10 volts and less, the I_D limit is doubled.

PACKAGING OF DIODE AND BRIDGE RECTIFIERS

REEL PACK

PACKAGE	PACKING CODE	EA PER REEL	EA PER INNER BOX	COMPONENT SPACE (mm)	TAPE SPACE (mm)	REEL DIA (mm)	CARTON SIZE (mm)	EA PER CARTON	GROSS WEIGHT(Kg)
SMC	-T	500	1,500	---	---	178	390*205*310	12,000	6.65
SMC	-W	3,000	3,000	---	---	330	360*355*360	24,000	11.50

Marking Description

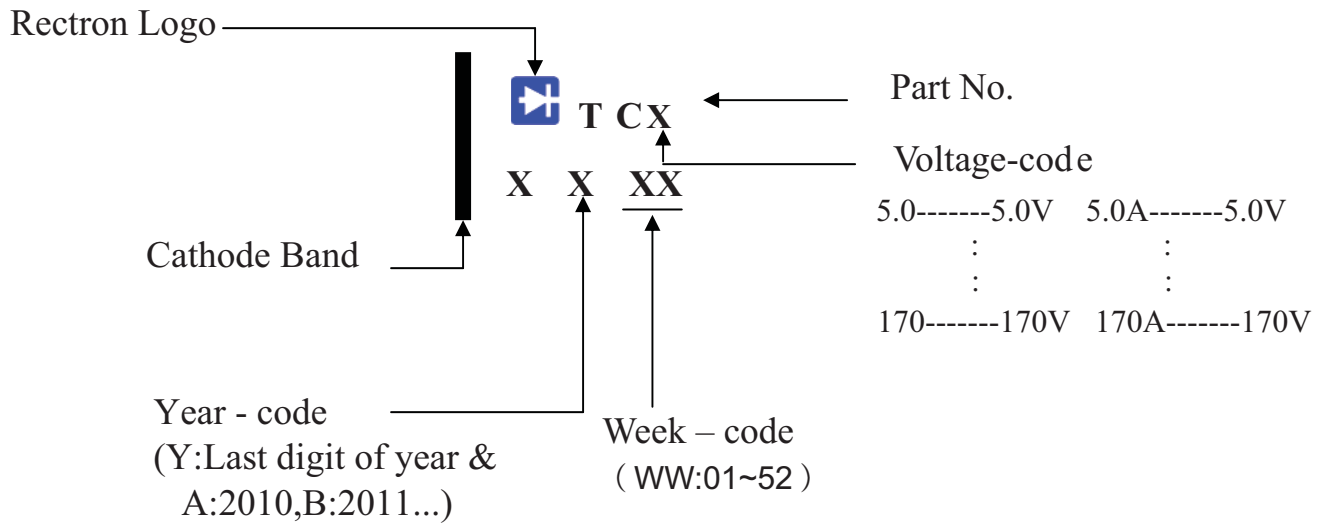

DISCLAIMER NOTICE

Rectron Inc reserves the right to make changes without notice to any product specification herein, to make corrections, modifications, enhancements or other changes. Rectron Inc or anyone on its behalf assumes no responsibility or liability for any errors or inaccuracies. Data sheet specifications and its information contained are intended to provide a product description only. "Typical" parameters which may be included on RECTRON data sheets and/ or specifications can and do vary in different applications and actual performance may vary over time. Rectron Inc does not assume any liability arising out of the application or use of any product or circuit.

Rectron products are not designed, intended or authorized for use in medical, life-saving implant or other applications intended for life-sustaining or other related applications where a failure or malfunction of component or circuitry may directly or indirectly cause injury or threaten a life without expressed written approval of Rectron Inc. Customers using or selling Rectron components for use in such applications do so at their own risk and shall agree to fully indemnify Rectron Inc and its subsidiaries harmless against all claims, damages and expenditures.