



# MMBT2222ATB

## NPN GENERAL PURPOSE SWITCHING TRANSISTOR

**VOLTAGE** 40 Volt    **POWER** 225 mWatt

**SOT-523**    Unit : inch(mm)

### FEATURES

- NPN epitaxial silicon, planar design
- Collector-emitter voltage  $V_{CE} = 40V$
- Collector current  $I_C = 600mA$
- Lead free in compliance with EU RoHS 2011/65/EU directive
- Green molding compound as per IEC61249 Std. . (Halogen Free)

### MECHANICAL DATA

- Case: SOT-523, Plastic
- Terminals: Solderable per MIL-STD-750, Method 2026
- Approx. Weight: 0.00007 ounces, 0.002 grams
- Marking: MY

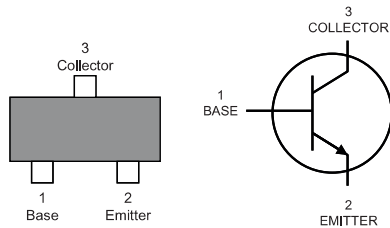
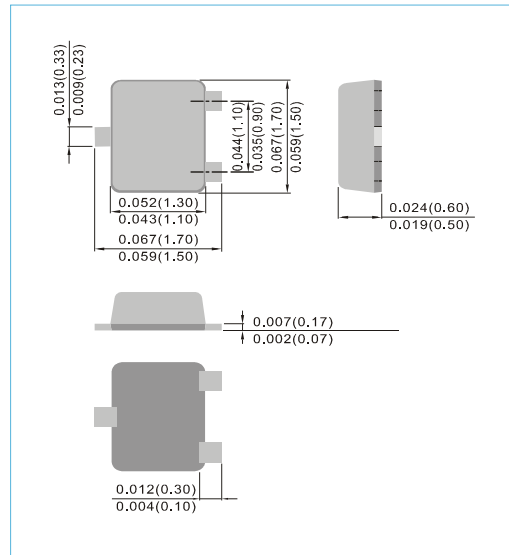

### ABSOLUTE RATINGS

PARAMETER	Symbol	Value	Units
Collector - Emitter Voltage	$V_{CEO}$	40	V
Collector - Base Voltage	$V_{CBO}$	75	V
Emitter - Base Voltage	$V_{EBO}$	6.0	V
Collector Current - Continuous	$I_C$	600	mA

### THERMAL CHARACTERISTICS

PARAMETER	Symbol	Value	Units
Max Power Dissipation (Note 1)	$P_{TOT}$	225	mW
Thermal Resistance , Junction to Ambient	$R_{\theta JA}$	833	$^{\circ}C/W$
Operating Junction and Storage Temperature Range	$T_J, T_{STG}$	-55 to +150	$^{\circ}C$

Note 1 : Transistor mounted on FR-5 board 1 x 0.75 x 0.062 in.



# MMBT2222ATB

## ELECTRICAL CHARACTERISTICS

PARAMETER	Symbol	Test Condition	MIN.	TYP.	MAX.	Units
Collector - Emitter Breakdown Voltage	$V_{(BR)CEO}$	$I_C=1.0mA, I_B=0$	40	-	-	V
Collector - Base Breakdown Voltage	$V_{(BR)CBO}$	$I_C=10\mu A, I_E=0$	75	-	-	V
Emitter - Base Breakdown Voltage	$V_{(BR)EBO}$	$I_E=10\mu A, I_C=0$	6.0	-	-	V
Base Cutoff Current	$I_{BL}$	$V_{CE}=60V, V_{EB}=3.0V$	-	-	20	nA
Collector Cutoff Current	$I_{CEX}$	$V_{CE}=60V, V_{EB}=3.0V$	-	-	10	nA
	$I_{CBO}$	$V_{CE}=60V, I_E=0, V_{CE}=60V, I_E=0, T_J=125^\circ C$	-	-	10 10	nA uA
Emitter Cutoff Current	$I_{EBO}$	$V_{EB}=3.0V, I_C=0,$	-	-	100	nA
DC Current Gain	$h_{FE}$	$I_C=0.1mA, V_{CE}=10V$	35	-	-	-
		$I_C=1.0mA, V_{CE}=10V$	50	-	-	-
		$I_C=10mA, V_{CE}=10V$	75	-	-	-
		$I_C=10mA, V_{CE}=10V, T_J=125^\circ C$	35	-	-	-
		$I_C=150mA, V_{CE}=10V$ (Note 2)	100	-	300	-
		$I_C=150mA, V_{CE}=1V$ (Note 2)	50	-	-	-
Collector - Emitter Saturation Voltage (Note 2)	$V_{CE(SAT)}$	$I_C=150mA, I_B=15mA$	-	-	0.3	V
		$I_C=500mA, I_B=50mA$	-	-	1.0	V
Base - Emitter Saturation Voltage (Note 2)	$V_{BE(SAT)}$	$I_C=150mA, I_B=15mA$	0.6	-	1.2	V
		$I_C=500mA, I_B=50mA$	-	-	2.0	V
Collector - Base Capacitance	$C_{CBO}$	$V_{CB}=10V, I_E=0, f=1MHz$	-	-	8.0	pF
Emitter - Base Capacitance	$C_{EBO}$	$V_{CB}=0.5V, I_C=0, f=1MHz$	-	-	25	pF
Delay Time	$t_d$	$V_{CC}=3V, V_{BE}=-5V, I_C=150mA, I_B=15mA$	-	-	10	ns
Rise Time	$t_r$	$V_{CC}=3V, V_{BE}=-5V, I_C=150mA, I_B=15mA$	-	-	25	ns
Storage Time	$t_s$	$V_{CC}=30V, I_C=150mA, I_B1=I_B2=15mA$	-	-	225	ns
Fall Time	$t_f$	$V_{CC}=30V, I_C=150mA, I_B1=I_B2=15mA$	-	-	60	ns

Note 2: Pulse Test: Pulse Width < 300 us, Duty Cycle < 2.0%.

### SWITCHING TIME EQUIVALENT TEST CIRCUITS

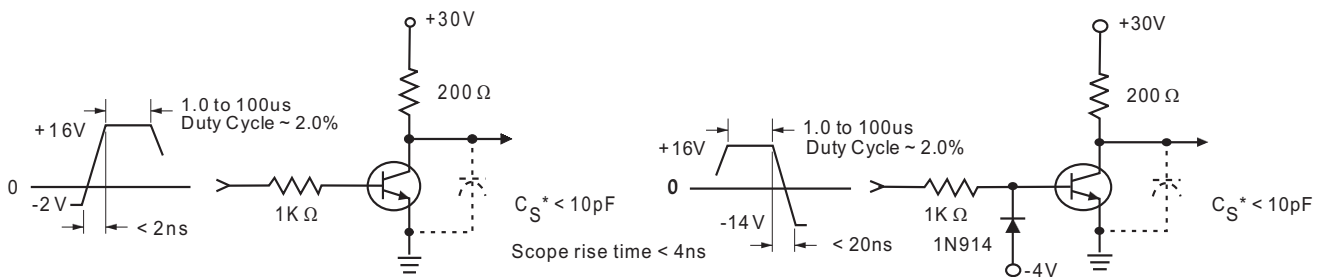

Fig. 1 Turn-On Time

Fig. 2 Turn-Off Time

\* Total shunt capacitance of test jig, connectors, and oscilloscope



# MMBT2222ATB

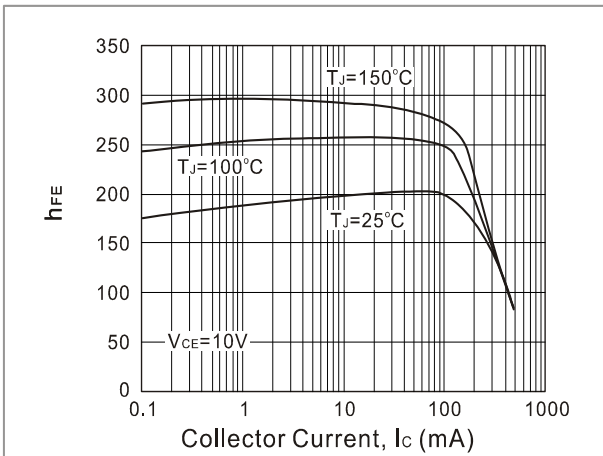

**Fig. 3. Typical  $h_{FE}$  vs Collector Current**

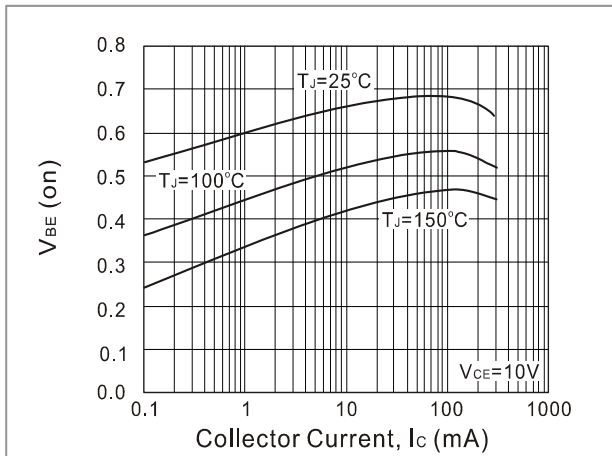

**Fig. 4. Typical  $V_{BE}$  vs Collector Current**

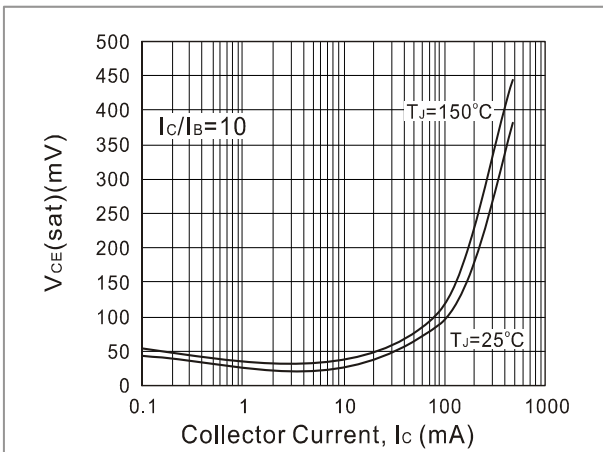

**Fig. 5. Typical  $V_{CE(sat)}$  vs Collector Current**

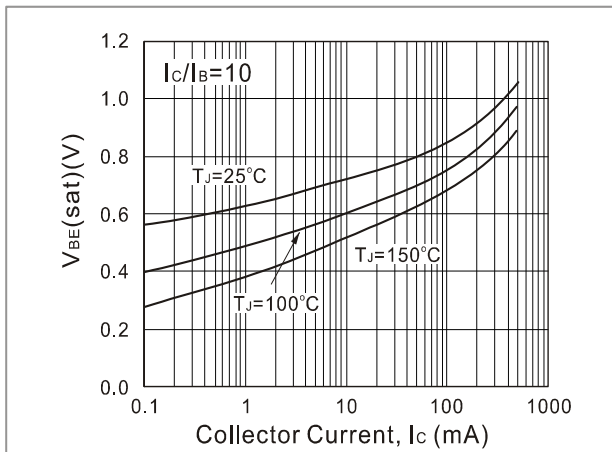

**Fig. 6. Typical  $V_{BE(sat)}$  vs Collector Current**

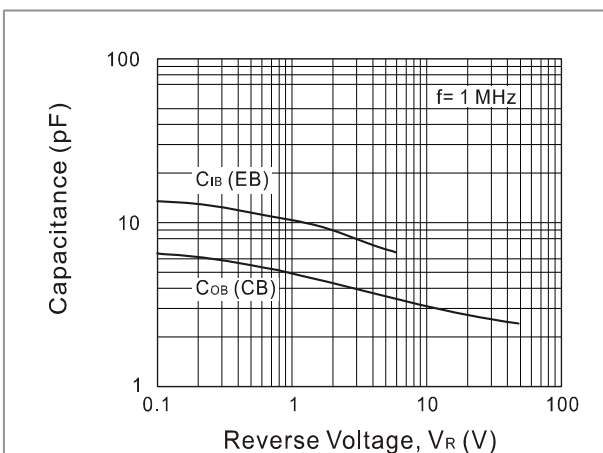

**Fig. 7. Typical Capacitances vs Reverse Voltage**

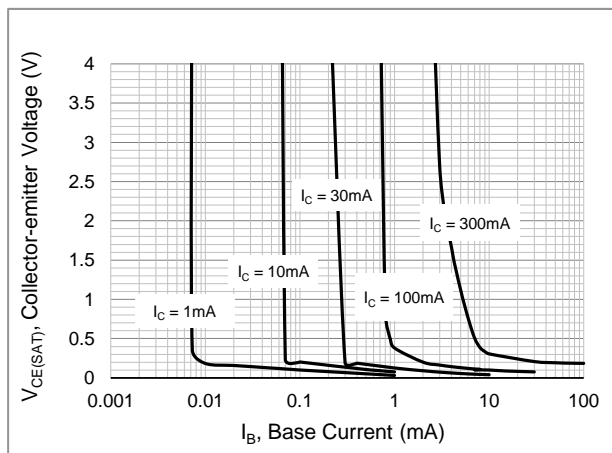

**Fig. 8. Typical Collector Saturation Region**



# MMBT2222ATB

## MOUNTING PAD LAYOUT

SOT-523

Unit : inch(mm)

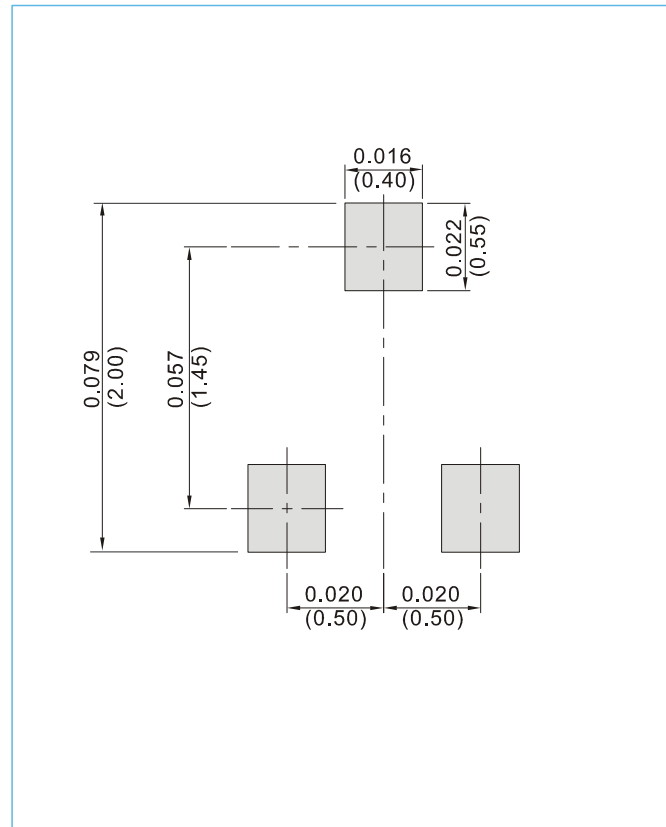

## ORDER INFORMATION

- Packing information  
T/R - 4K per 7" plastic Reel



# MMBT2222ATB

Part No\_packing code\_Version

MMBT2222ATB\_R1\_00001

For example :

RB500V-40\_R2\_00001

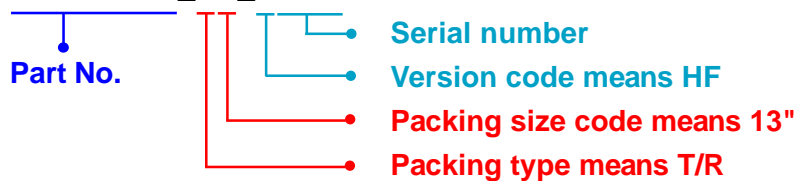

Packing Code XX				Version Code XXXXX		
Packing type	1 <sup>st</sup> Code	Packing size code	2 <sup>nd</sup> Code	HF or RoHS	1 <sup>st</sup> Code	2 <sup>nd</sup> ~5 <sup>th</sup> Code
Tape and Ammunition Box (T/B)	A	N/A	0	HF	0	serial number
Tape and Reel (T/R)	R	7"	1	RoHS	1	serial number
Bulk Packing (B/P)	B	13"	2			
Tube Packing (T/P)	T	26mm	X			
Tape and Reel (Right Oriented) (TRR)	S	52mm	Y			
Tape and Reel (Left Oriented) (TRL)	L	PANASERT T/B CATHODE UP (PBCU)	U			
FORMING	F	PANASERT T/B CATHODE DOWN (PBCD)	D			



# MMBT2222ATB

---

## Disclaimer

- Reproducing and modifying information of the document is prohibited without permission from Panjit International Inc..
- Panjit International Inc. reserves the rights to make changes of the content herein the document anytime without notification. Please refer to our website for the latest document.
- Panjit International Inc. disclaims any and all liability arising out of the application or use of any product including damages incidentally and consequentially occurred.
- Panjit International Inc. does not assume any and all implied warranties, including warranties of fitness for particular purpose, non-infringement and merchantability.
- Applications shown on the herein document are examples of standard use and operation. Customers are responsible in comprehending the suitable use in particular applications. Panjit International Inc. makes no representation or warranty that such applications will be suitable for the specified use without further testing or modification.
- The products shown herein are not designed and authorized for equipments requiring high level of reliability or relating to human life and for any applications concerning life-saving or life-sustaining, such as medical instruments, transportation equipment, aerospace machinery et cetera. Customers using or selling these products for use in such applications do so at their own risk and agree to fully indemnify Panjit International Inc. for any damages resulting from such improper use or sale.
- Since Panjit uses lot number as the tracking base, please provide the lot number for tracking when complaining.