

Image-Reject Mixer

32 - 37 GHz



MAMX-011116

Rev. V1

Features

- Passive Mixer - No Bias Required
- 9 dB Conversion Loss
- Nominal LO drive of +13 dBm
- 16 dBm Input IP3
- 35 dB LO to RF Isolation
- 30 dBc of Image Rejection
- IF Bandwidth: DC to 5 GHz
- 2 mm, 8-Lead PDFN
- RoHS* Compliant

Applications

- Test & Measurement
- Microwave Radio
- Radar

Description

MAMX-011116 is an image reject mixer in a miniature 2mm package. This mixer offers a conversion loss of 9 dB and high linearity of 16 dBm input IP3. The typical image rejection is 30 dBc.

This mixer is well suited for applications such as test and measurement, microwave radio and radar.

The mixer considered as a part of a chip set that includes mixer and LO buffer amplifier MAAL-011198 LNA.

Functional Schematic

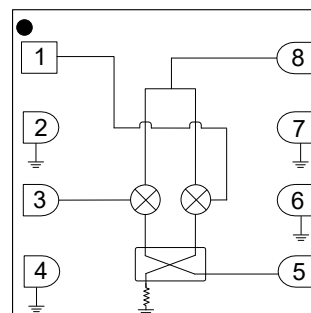

Pin Configuration³

Pin #	Function
1	IF2
2, 4, 6, 7	GND
3	IF1
5	LO
8	RF

3. The backside of the die must be connected to RF, DC and thermal ground.

Ordering Information^{1,2}

Part Number	Package
MAMX-011116-TR0100	100 Piece Reel
MAMX-011116-TR0500	500 Piece Reel
MAMX-011116-SMB	Sample Board

1. Reference Application Note M513 for reel size information.
2. All sample boards include 5 loose parts.

* Restrictions on Hazardous Substances, compliant to current RoHS EU directive.

Electrical Specifications⁴: $F_{IF} = 1 \text{ GHz}$, $P_{LO} = 13 \text{ dBm}$, $T_A = +25^\circ\text{C}$, $Z_0 = 50 \Omega$

Parameter	Test Conditions	Units	Min.	Typ.	Max.
RF Frequency	RF LO IF	GHz	32 27 0	—	37 42 5
LO Power	—	dBm	9	13	15
Conversion Loss	—	dB	—	9	12
Image Rejection	—	dBc	15	30	—
Input P1dB	—	dBm	—	6	—
Input IP3	$P_{RF} = -10 \text{ dBm/tone}$, $\Delta f = 1 \text{ MHz}$	dBm	—	16	—
Input IP2	$P_{RF} = -10 \text{ dBm/tone}$, $\Delta f = 1 \text{ MHz}$	dBm	—	47	—
Isolation	LO-to-RF LO-to-IF RF-to-IF	dB	—	35 40 30	—
Return Loss	RF LO IF	dB	—	10 10 12	—

4. All specifications refer to down-conversion operation, unless otherwise noted.

Maximum Operating Conditions

Parameter	Absolute Maximum
LO Power	18 dBm
RF or IF Power	10 dBm
Junction Temperature	+150°C
Operating Temperature	-40°C to +85°C

Absolute Maximum Ratings^{5,6}

Parameter	Absolute Maximum
LO Power	23 dBm
RF or IF Power	20 dBm
Storage Temperature	-65°C to +150°C

5. Exceeding any one or combination of these limits may cause permanent damage to this device.

6. MACOM does not recommend sustained operation near these survivability limits.

Image-Reject Mixer 32 - 37 GHz



MAMX-011116

Rev. V1

Typical Performance: Down Conversion, Upper Side Band (USB), IF = 1 GHz, @ 25°C

Conversion Loss over LO drive

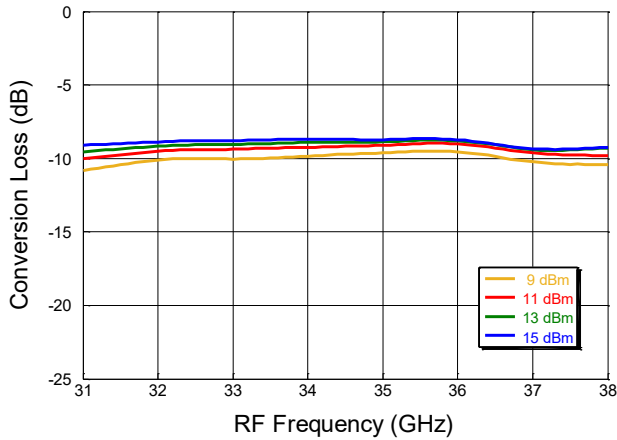
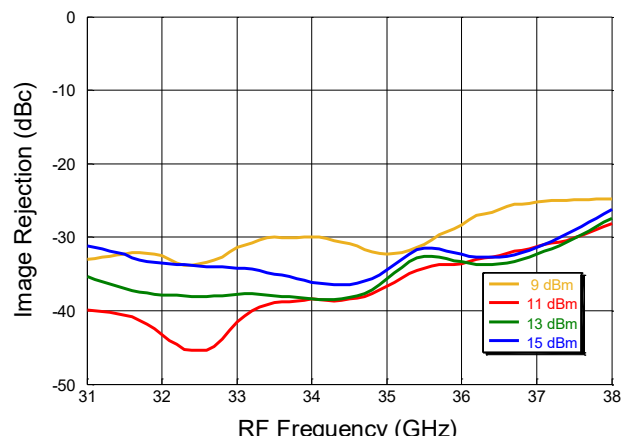
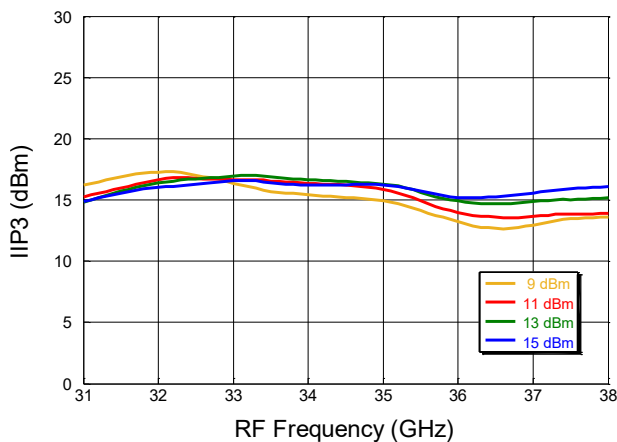

Image Rejection over LO drive



IIP3 over LO drive vs. RF Frequency



IIP2 over LO drive vs. RF Frequency

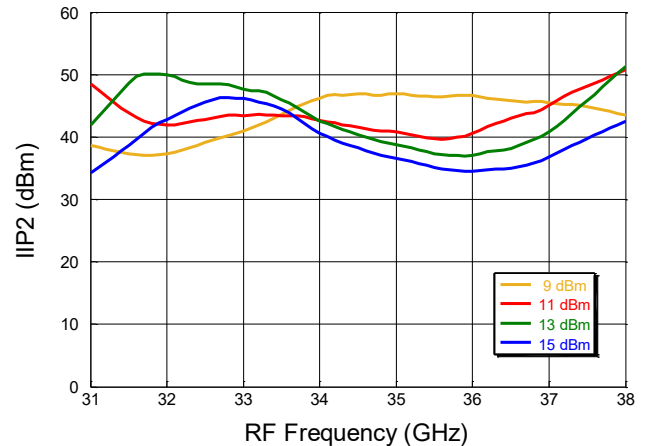

P1dB over LO drive vs. RF Frequency

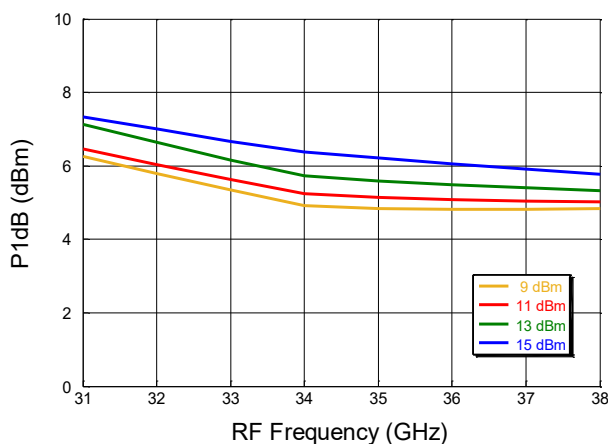

Image-Reject Mixer 32 - 37 GHz



MAMX-011116

Rev. V1

Typical Performance: Down Conversion, Lower Side Band (LSB), IF = 1 GHz, @ 25°C

Conversion Loss over LO drive

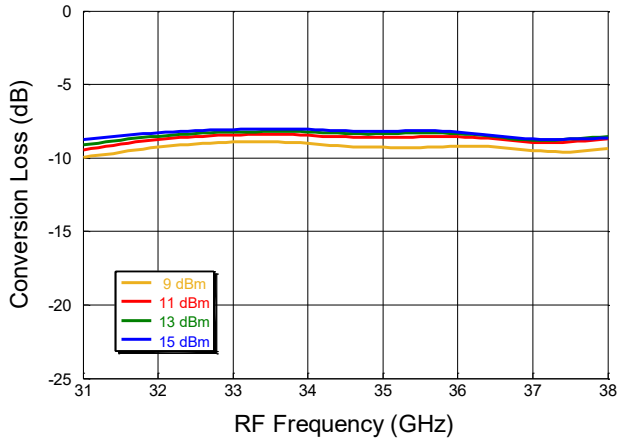
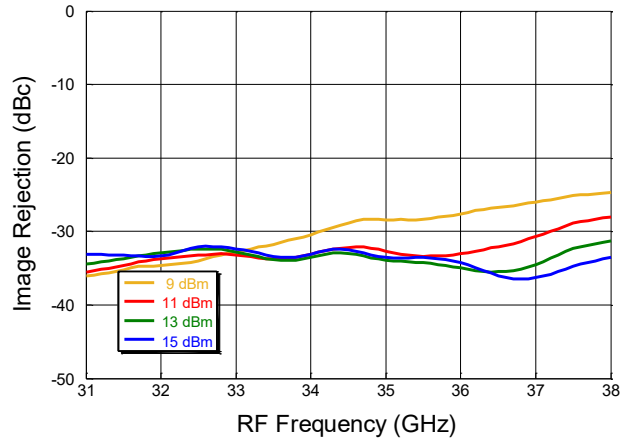
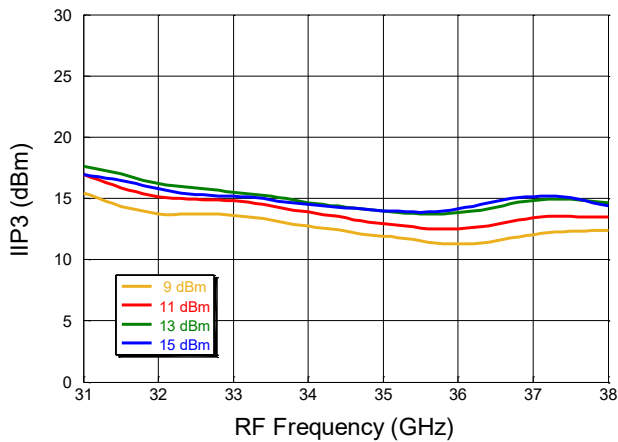

Image Rejection over LO drive



IIP3 over LO drive vs. RF Frequency



IIP2 over LO drive vs. RF Frequency

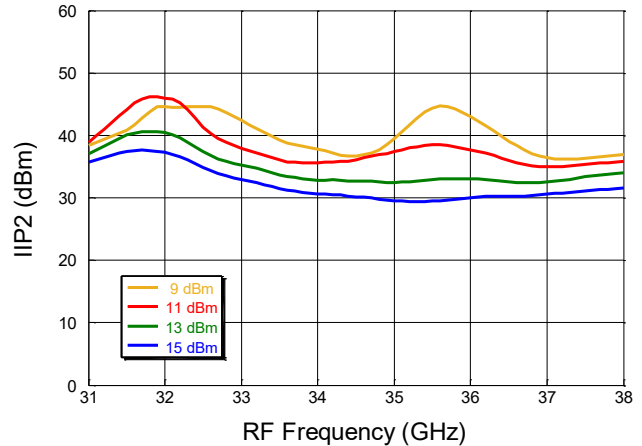

Typical Performance: Measured without hybrid

RF to IF Isolation vs. RF Frequency

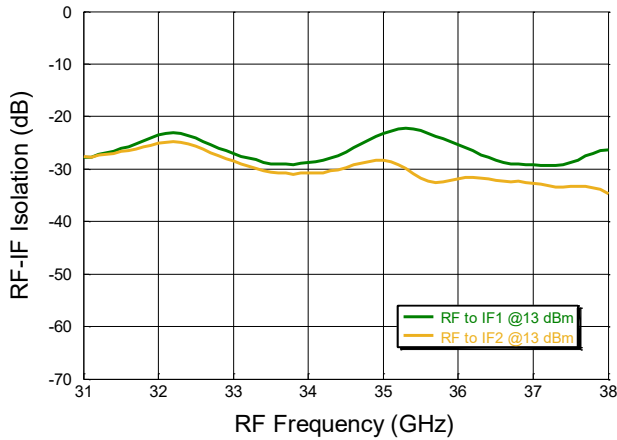

LO to IF Isolation vs. LO Frequency

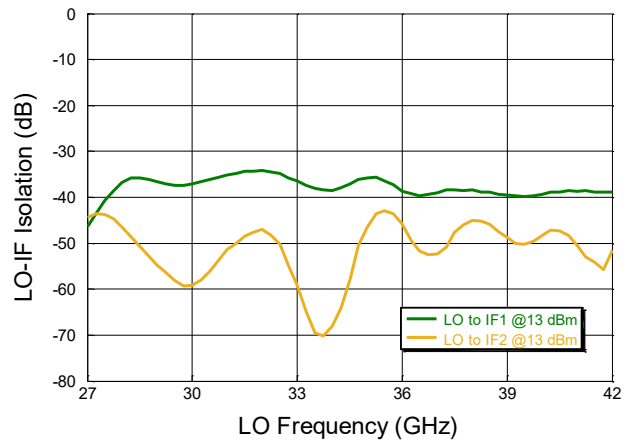

LO to RF Isolation vs. LO Frequency

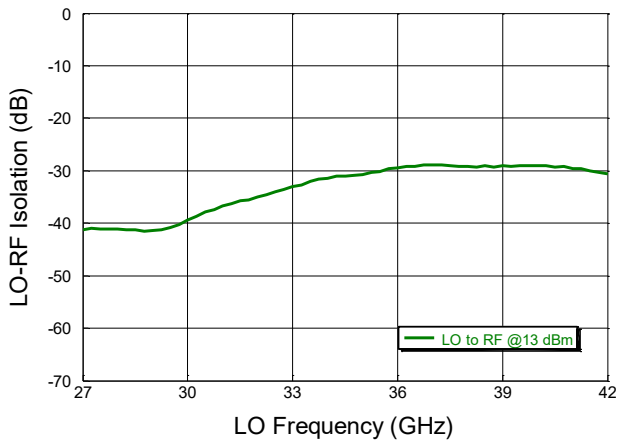

Conversion loss vs. IF Frequency (LO 32GHz)

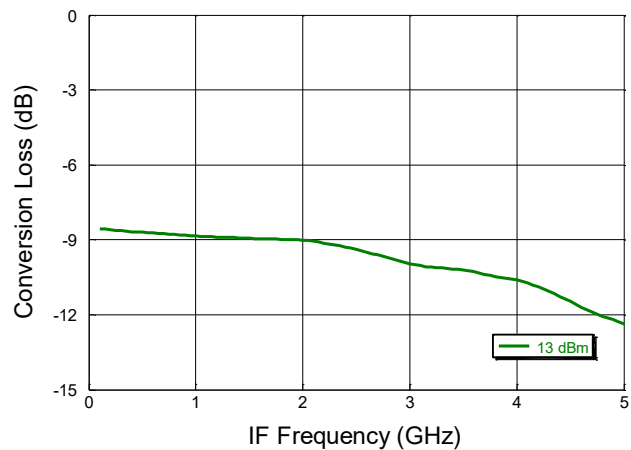

Typical Performance: Port Return Losses

IF1 & IF2 Return Loss vs. IF Frequency

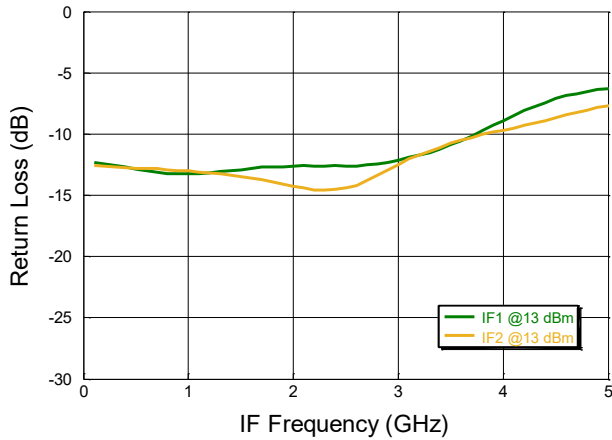

LO Return Loss vs. LO Frequency

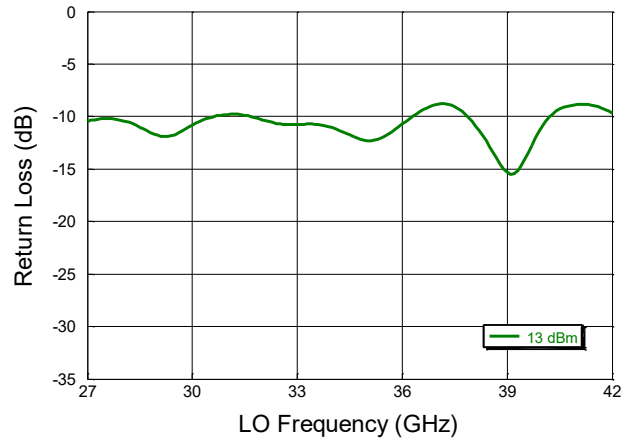

RF Return Loss vs. RF Frequency

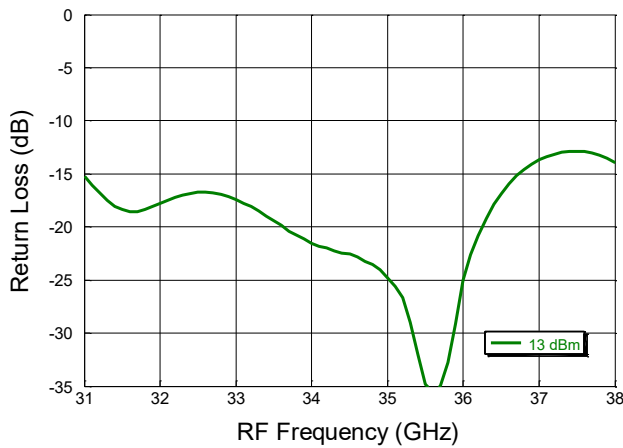

Image-Reject Mixer 32 - 37 GHz



MAMX-011116

Rev. V1

Typical Performance: Down Conversion, Upper Side band (USB), IF = 1 GHz, over Temp.

Conversion Loss vs. Frequency

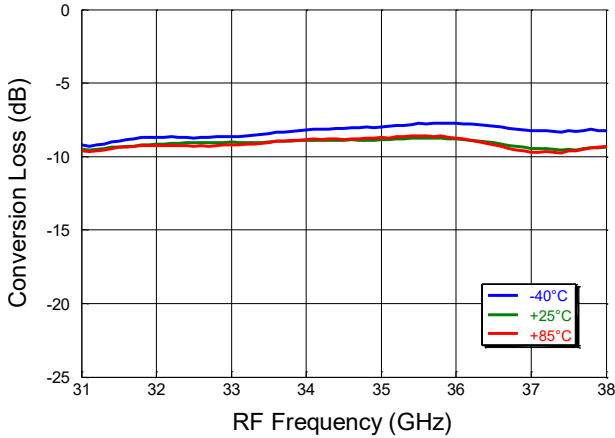
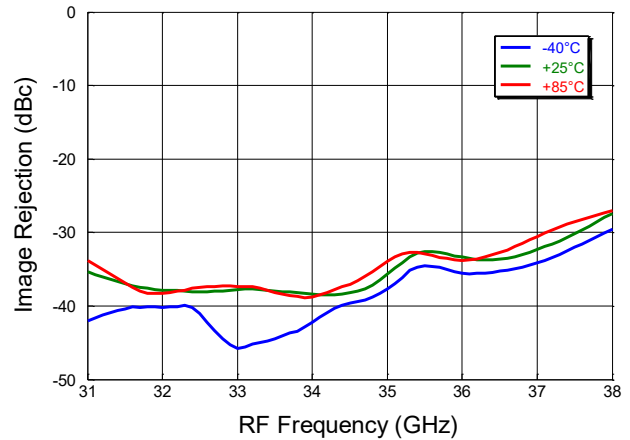
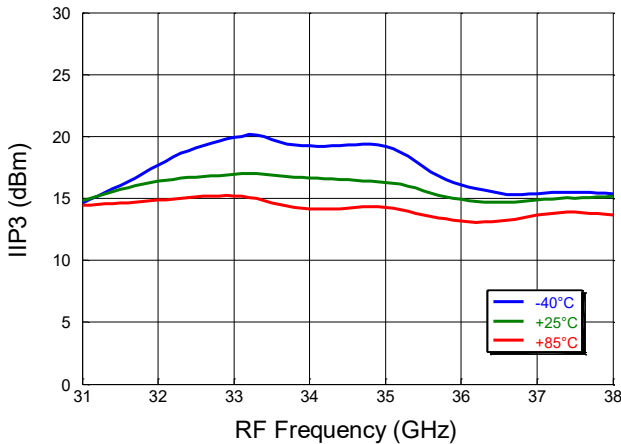

Image Rejection vs. Frequency



IIP3 over LO Drive vs. RF Frequency



IIP2 over LO Drive vs. RF Frequency

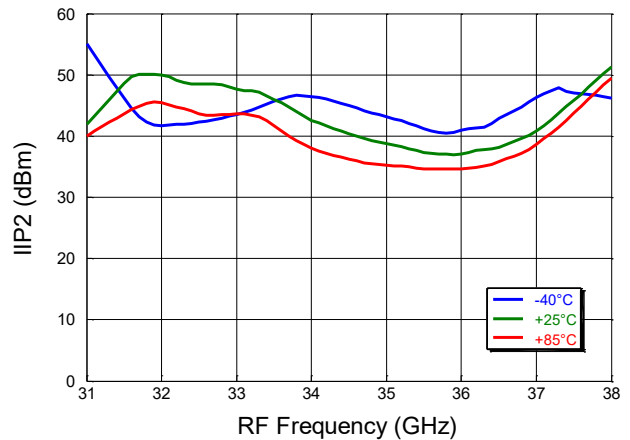

P1dB vs. RF Frequency

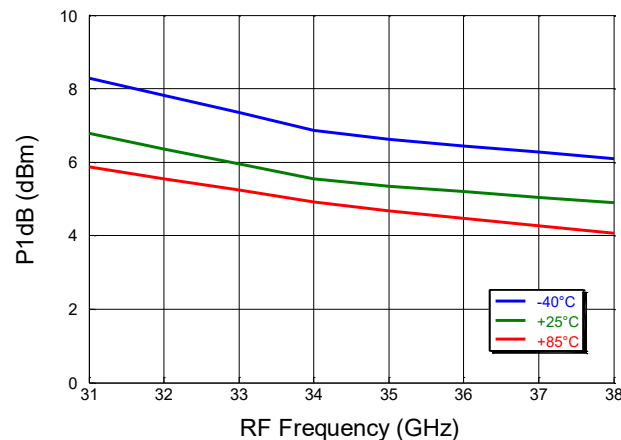

Typical Performance: Up conversion, Upper Side Band (USB), IF = 1 GHz, @ 25°C

Conversion Loss over LO drive

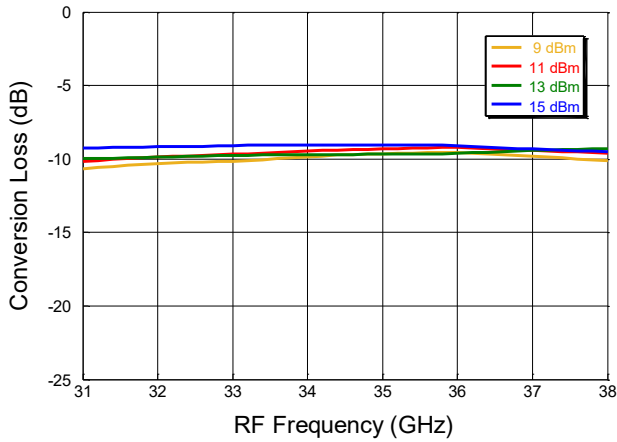

Single Sideband Rejection over LO drive

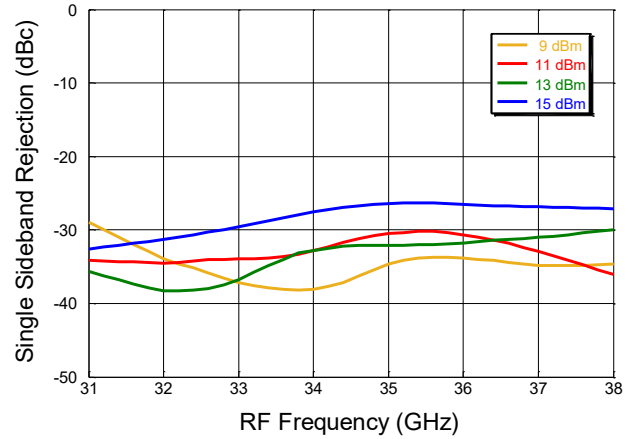

IIP3 over LO drive vs. RF Frequency

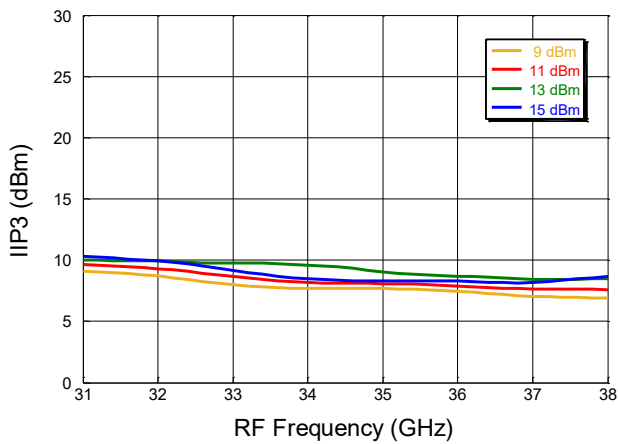

P1dB over LO drive vs. RF Frequency

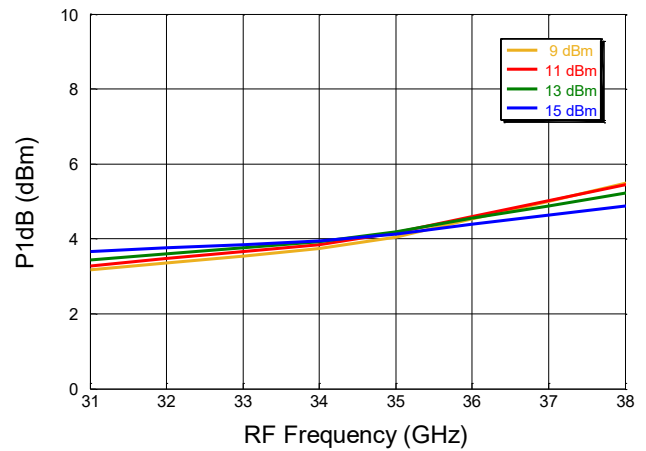

Image-Reject Mixer 32 - 37 GHz



MAMX-011116

Rev. V1

Typical Performance: Up Conversion, Lower Side Band (LSB), IF = 1 GHz @ 25°C

Conversion Loss over LO drive

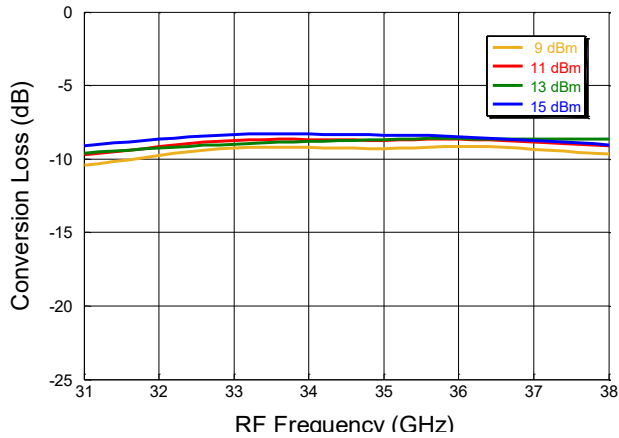

Single Sideband Rejection over LO drive

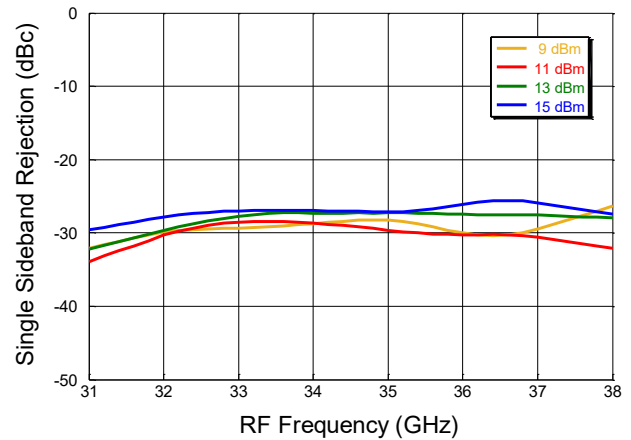

IIP3 over LO drive vs. RF Frequency

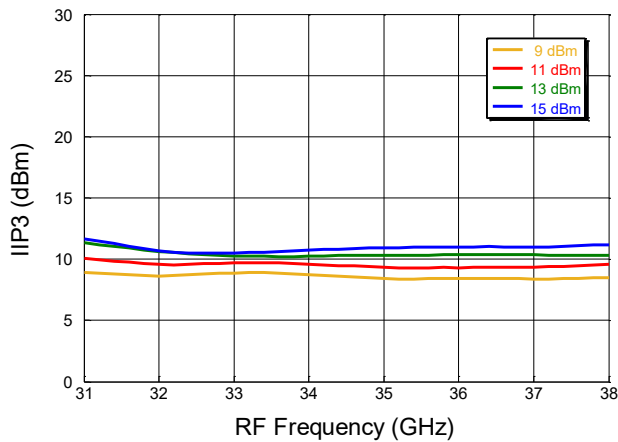

Typical Performance: Up Conversion, Upper side band (USB), IF = 1 GHz, over Temp.

Conversion Loss vs. Frequency (Up Conversion)

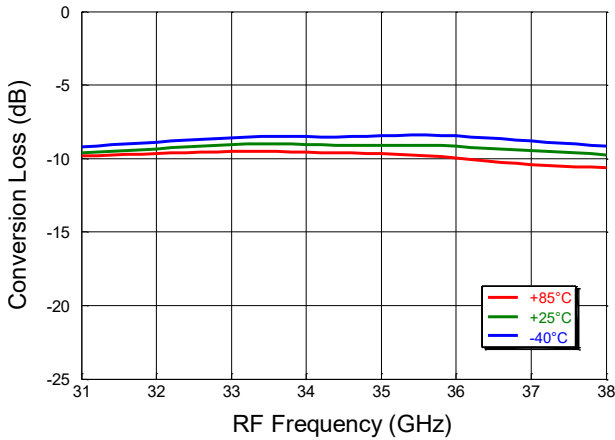

Single Sideband Rejection vs. Frequency

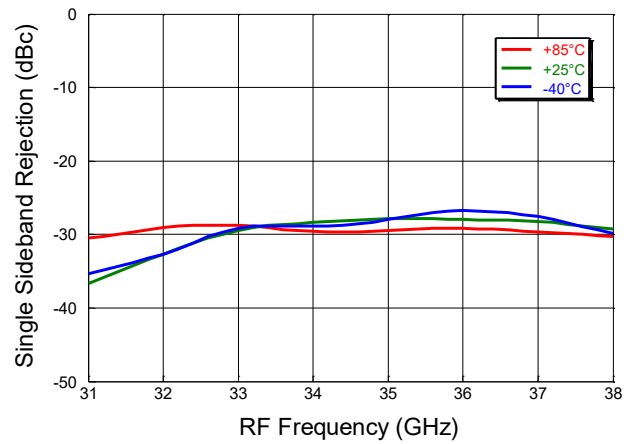

IIP3 over LO Drive vs. RF Frequency (Up Conversion)

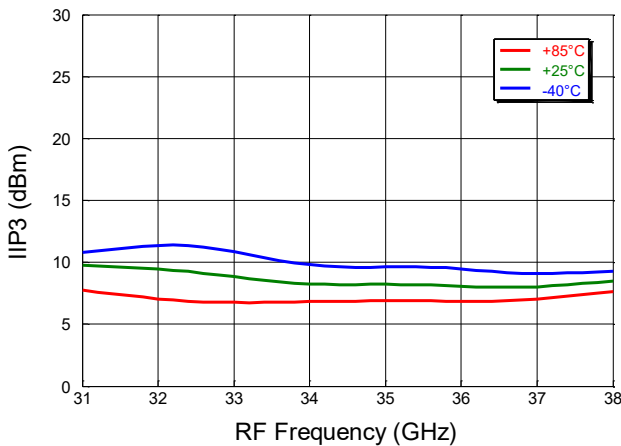

P1dB vs. RF Frequency (Up Conversion)

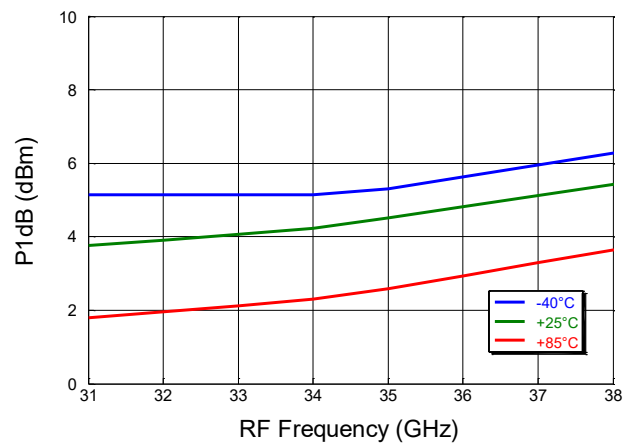

Typical Performance: Down conversion, Upper Side Band (USB), @ 25°C, IF = 2 GHz

Conversion Loss over LO drive

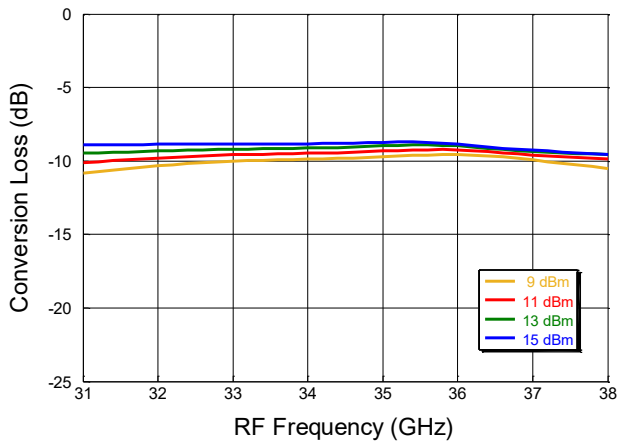
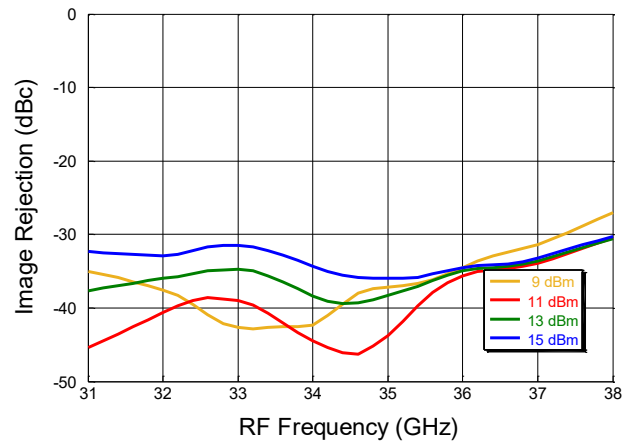
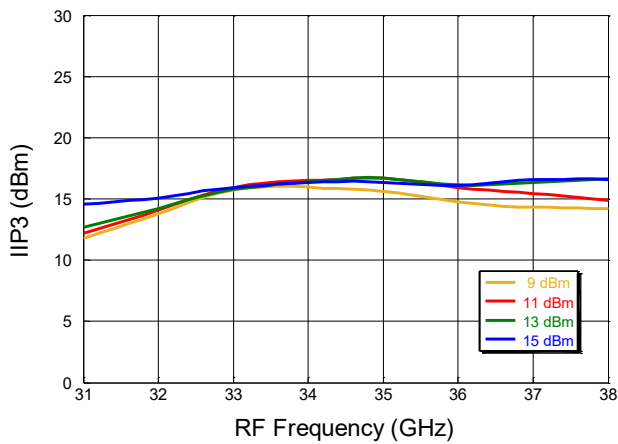

Image Rejection over LO drive



IIP3 over LO drive vs. RF Frequency



IIP2 over LO drive vs. RF Frequency

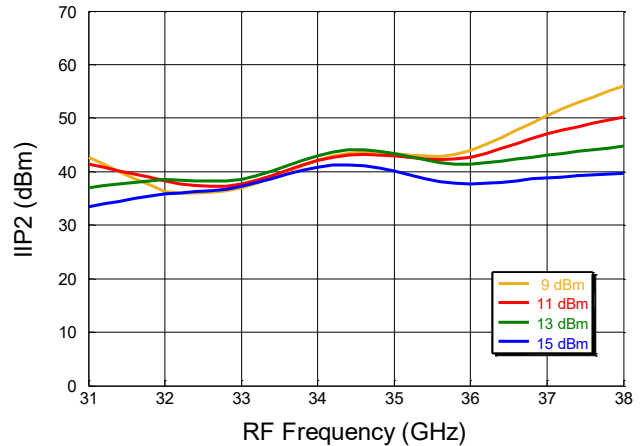

Image-Reject Mixer 32 - 37 GHz



MAMX-011116

Rev. V1

Typical Performance: Down Conversion, Lower Side Band (LSB), @ 25°C, IF = 2 GHz

Conversion Loss over LO drive

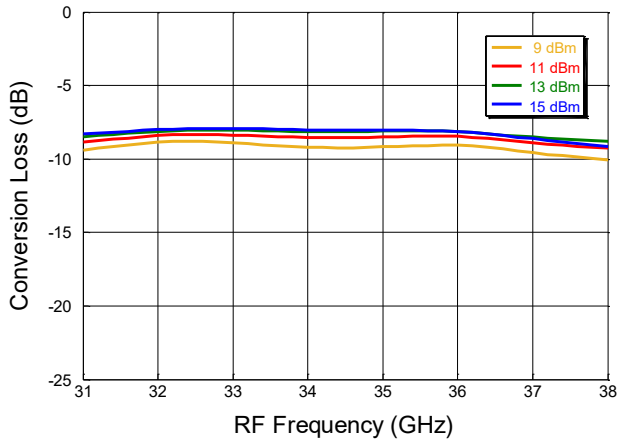
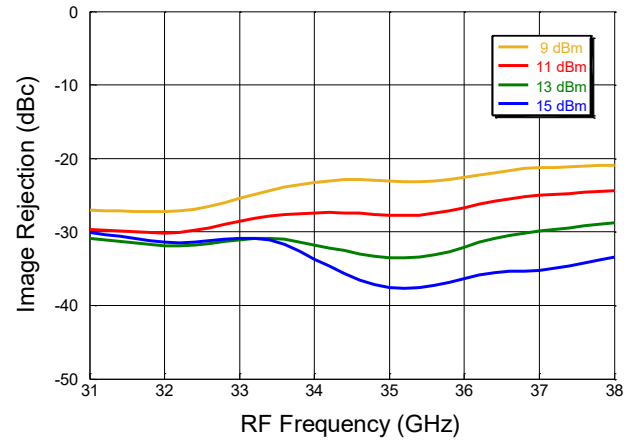
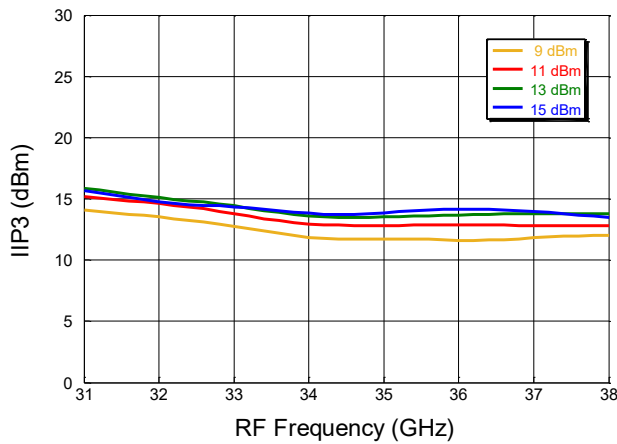

Image Rejection over LO drive



IIP3 over LO drive vs. RF Frequency



IIP2 over LO drive vs. RF Frequency

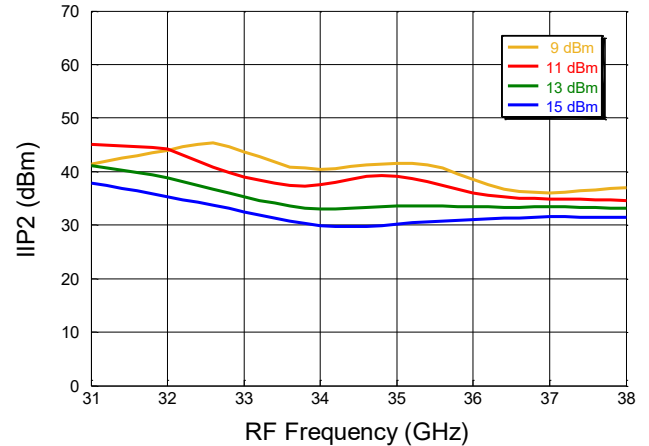

Typical Performance: Up Conversion, Upper Side Band (USB), @ 25°C, IF = 2 GHz

Conversion Loss over LO drive

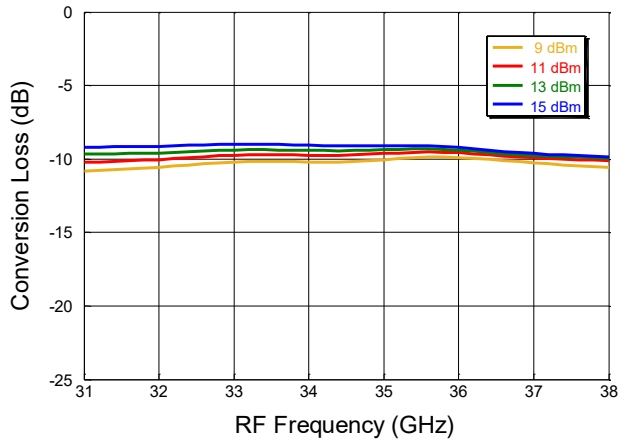

Single Sideband Rejection over LO drive

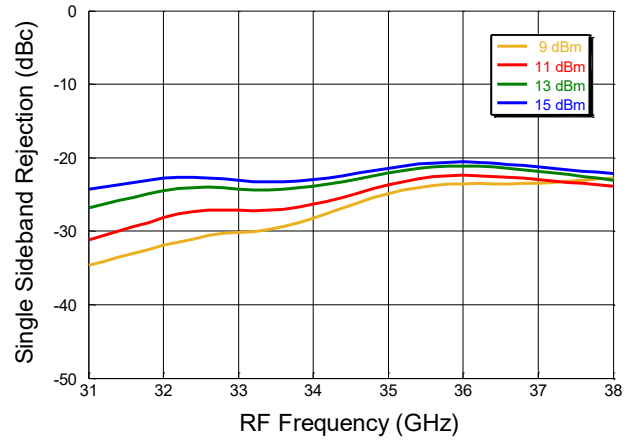

IIP3 over LO drive vs. RF Frequency

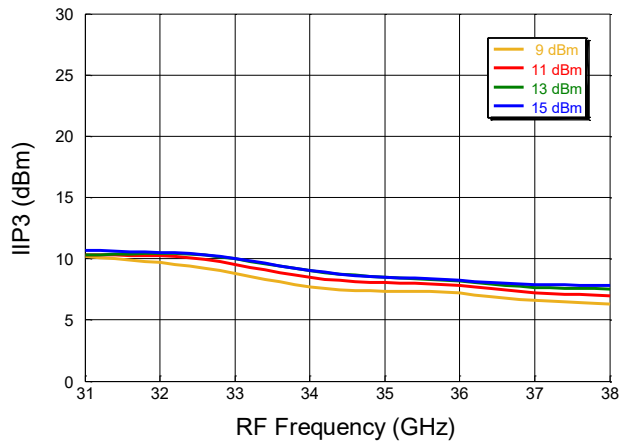

Typical Performance: Up Conversion, Lower Side Band (LSB), @ 25°C, IF = 2 GHz

Conversion Loss over LO drive

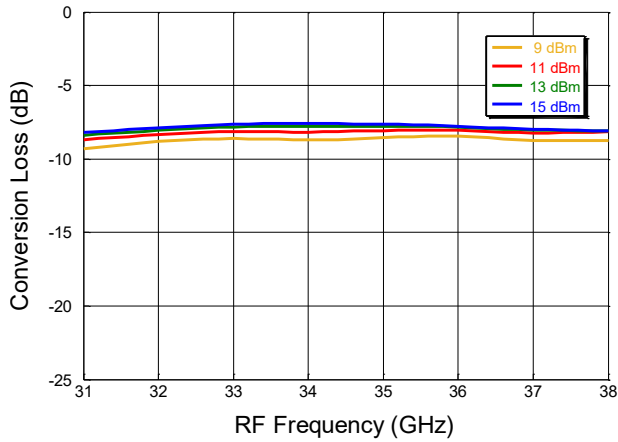

Single Sideband Rejection over LO drive

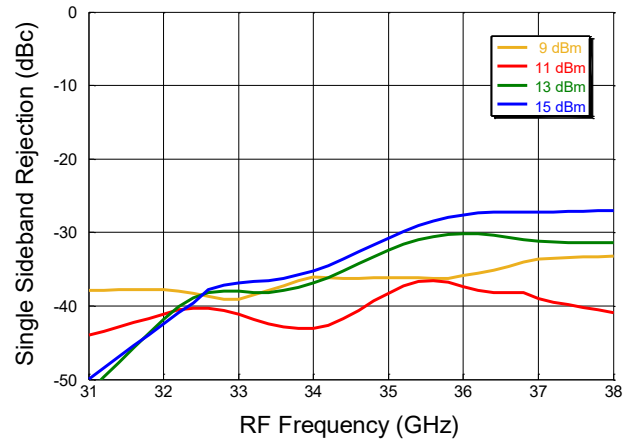

IIP3 over LO drive vs. RF Frequency

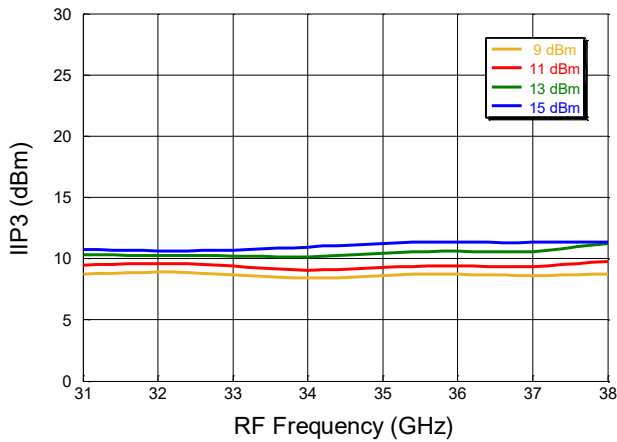

Typical Performance: Down Conversion, Upper Side Band (USB), @ 25°C, IF = 5 GHz

Conversion Loss over LO drive

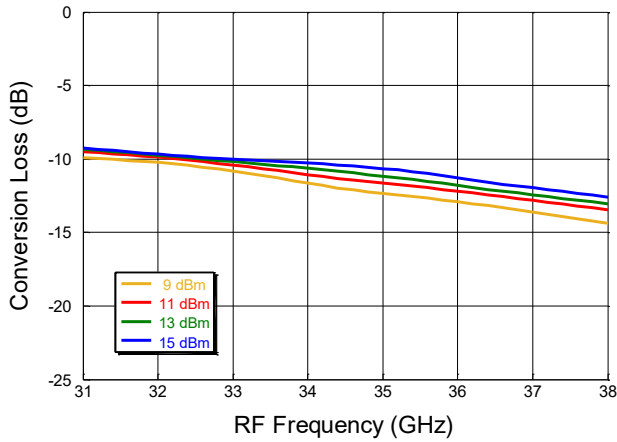
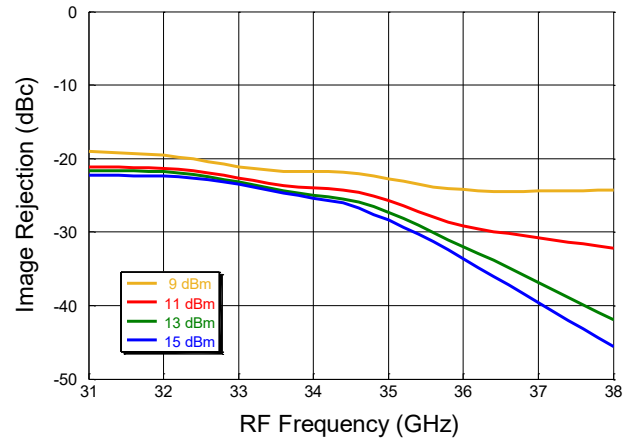
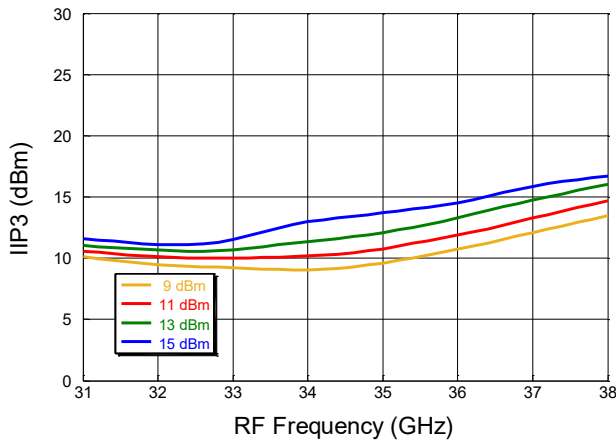

Image Rejection over LO drive



IIP3 over LO drive vs. RF Frequency



IIP2 over LO drive vs. RF Frequency

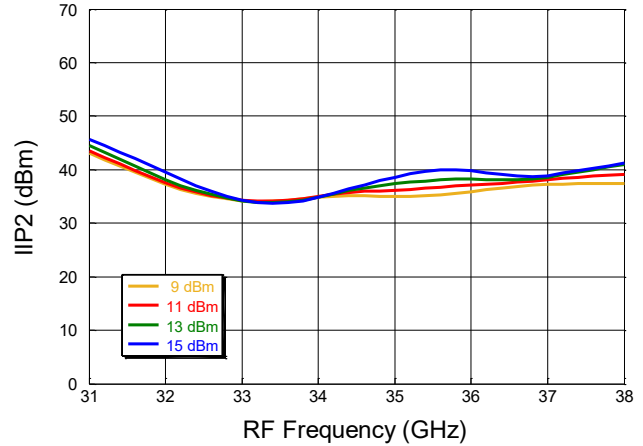

Typical Performance: Down Conversion, Lower Side Band (LSB), @ 25°C, IF = 5 GHz

Conversion Loss over LO drive

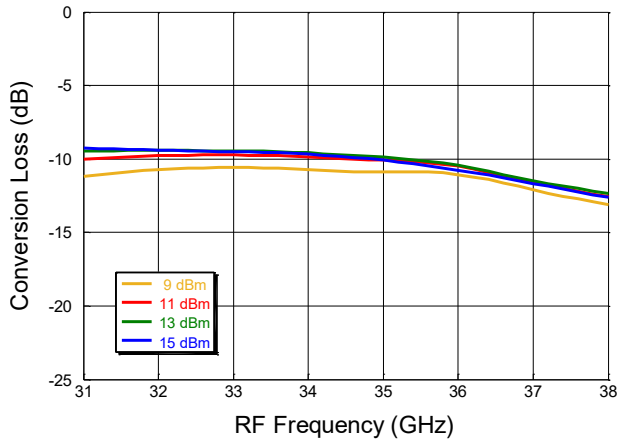
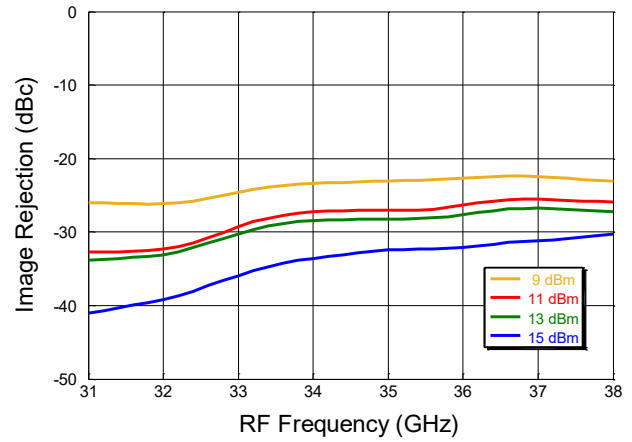
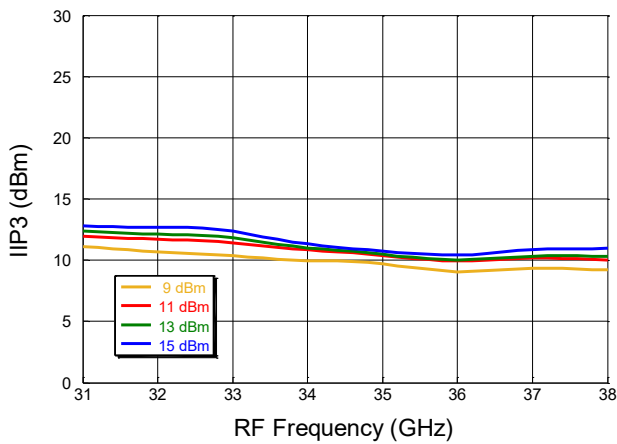

Image Rejection over LO drive



IIP3 over LO drive vs. RF Frequency



IIP2 over LO drive vs. RF Frequency

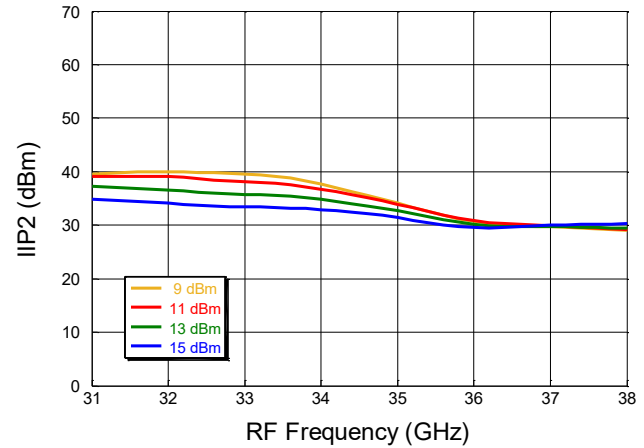

Typical Performance: Up Conversion, Upper Side Band (USB), @ 25°C, IF = 5 GHz

Conversion Loss over LO drive

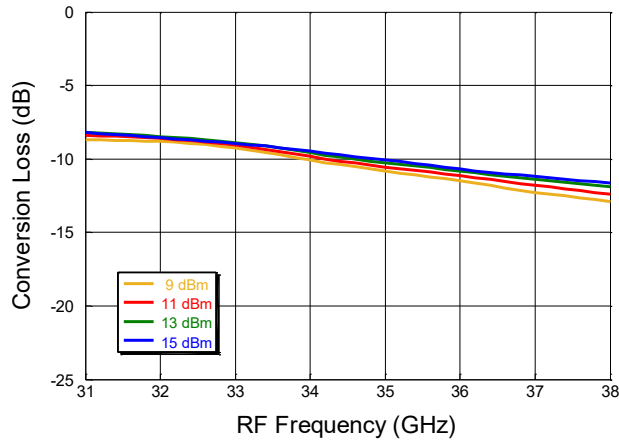

Single Sideband Rejection over LO drive

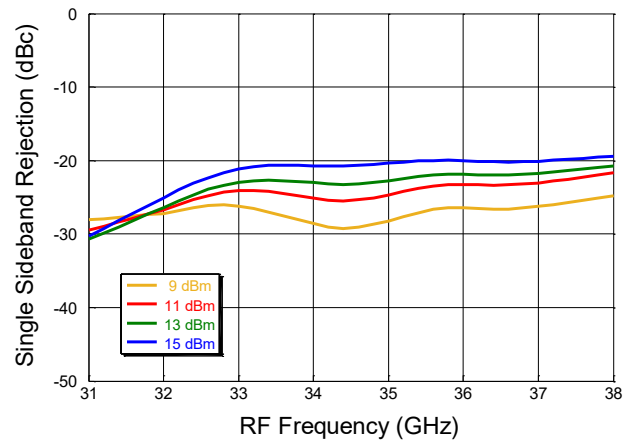

IIP3 over LO drive vs. RF Frequency

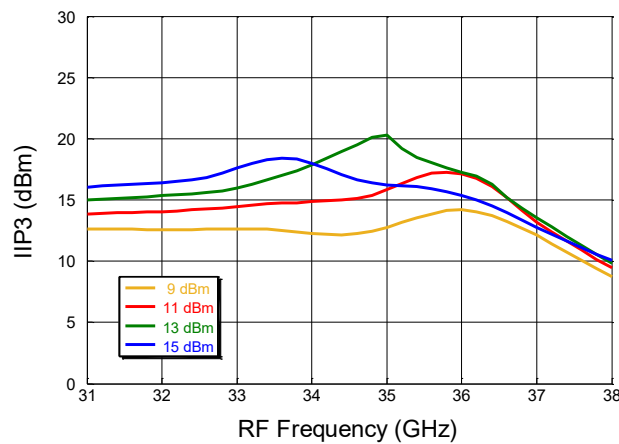

Typical Performance: Up Conversion, Lower Side Band (LSB), @ 25°C, IF = 5 GHz

Conversion Loss over LO drive

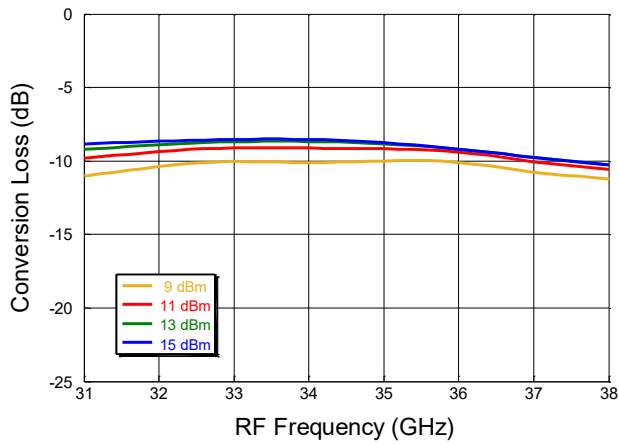

Single Sideband Rejection over LO drive

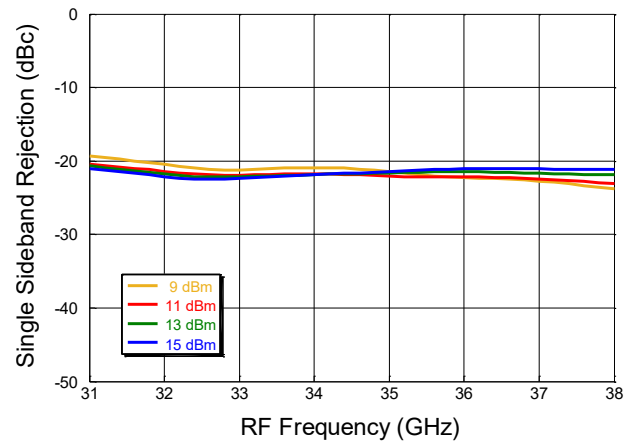

IIP3 over LO drive vs. RF Frequency

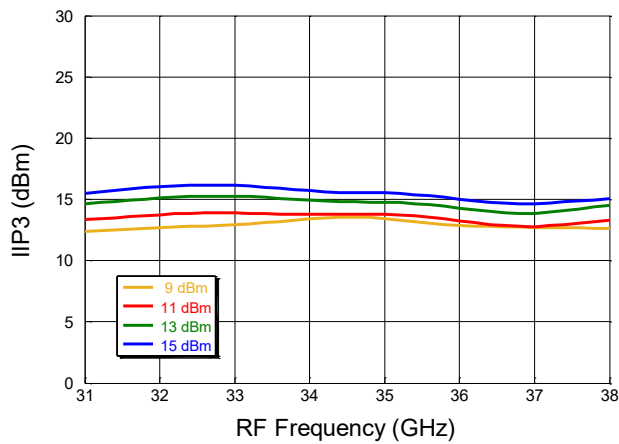

MxN Spurious Rejection at IF port (dBc IF)

RF = 35 GHz @ -10 dBm

LO = 34 GHz @ +13 dBm

Measured without Hybrid

'x' denotes level too low to measure

mxRF	nxLO				
	0	1	2	3	4
0	x	10	x	x	x
1	13	0	28	x	x
2	x	57	52	53	x
3	x	x	x	66	67
4	x	x	x	x	x

Handling Procedures

Please observe the following precautions to avoid damage:

Static Sensitivity

These electronic devices are sensitive to electrostatic discharge (ESD) and can be damaged by static electricity. Proper ESD control techniques should be used when handling these devices. The ESD levels are HBM Class 1C and CDM Class 3C.

Application Schematic

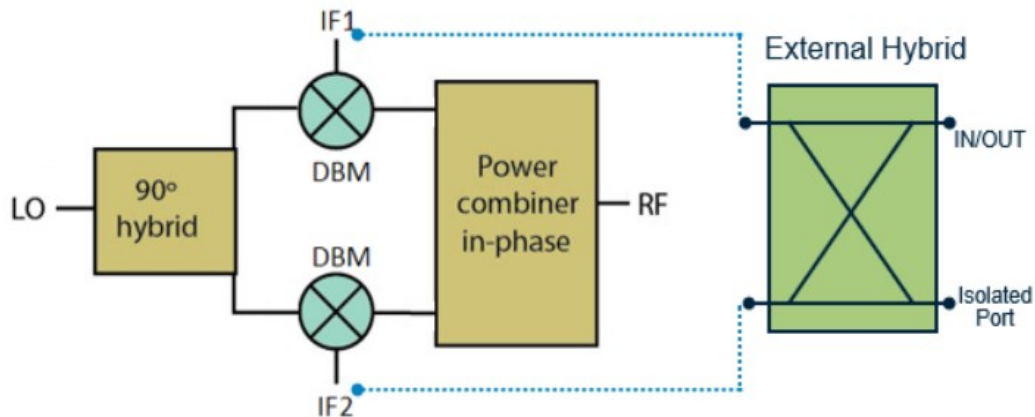

External Hybrid Operation

- Mixer data captured with external 90° hybrid. Connections in down converter mode as follows:
 - RF Upper Side Band (USB) mode attach hybrid 0° port to IF1 mixer port, and 90° hybrid port to IF2 mixer port.
 - RF Lower Side Band (LSB) mode attach hybrid 0° port to IF2 mixer port, and 90° hybrid port to IF1 mixer port.
 - Combined or wanted signal measured at input port, cancelled or image terminated at isolated port.
 - Connections are swapped in up conversion mode.

MACOM Technology Solutions Inc. ("MACOM"). All rights reserved.

These materials are provided in connection with MACOM's products as a service to its customers and may be used for informational purposes only. Except as provided in its Terms and Conditions of Sale or any separate agreement, MACOM assumes no liability or responsibility whatsoever, including for (i) errors or omissions in these materials; (ii) failure to update these materials; or (iii) conflicts or incompatibilities arising from future changes to specifications and product descriptions, which MACOM may make at any time, without notice. These materials grant no license, express or implied, to any intellectual property rights.

THESE MATERIALS ARE PROVIDED "AS IS" WITH NO WARRANTY OR LIABILITY, EXPRESS OR IMPLIED, RELATING TO SALE AND/OR USE OF MACOM PRODUCTS INCLUDING FITNESS FOR A PARTICULAR PURPOSE, MERCHANTABILITY, INFRINGEMENT OF INTELLECTUAL PROPERTY RIGHT, ACCURACY OR COMPLETENESS, OR SPECIAL, INDIRECT, INCIDENTAL, OR CONSEQUENTIAL DAMAGES WHICH MAY RESULT FROM USE OF THESE MATERIALS.

MACOM products are not intended for use in medical, lifesaving or life sustaining applications. MACOM customers using or selling MACOM products for use in such applications do so at their own risk and agree to fully indemnify MACOM for any damages resulting from such improper use or sale.