

NEGATIVE FIXED VOLTAGE REGULATOR

DESCRIPTION

The SG120 series of negative regulators offer self-contained, fixed-voltage capability with up to 1.5A of load current. With a variety of output voltages and four package options this regulator series is an optimum complement to the SG7800A/7800/120 line of three terminal regulators.

All protective features of thermal shutdown, current limiting, and safe-area control have been designed into these units and since these regulators require only a single output capacitor or a capacitor and 5mA minimum load for satisfactory performance, ease of application is assured.

Although designed as fixed-voltage regulators, the output voltage can be increased through the use of a simple voltage divider. The low quiescent drain current of the device insures good regulation when this method is used, especially for the SG120 series. Utilizing an improved Bandgap reference design, problems have been eliminated that are normally associated with the zener diode references, such as drift in output voltage and large changes in the line and load regulation

These devices are available in TO-257 (hermetically sealed TO-220), both isolated and non-isolated), TO-3, TO-39 and TO-66 power packages.

FEATURES

- Output current to 1.5A
- Excellent line and load regulation
- Foldback current limiting
- Thermal overload protection
- Voltages available: -5V, -12V, -15V
- Voltages Not Recommended For New Designs: -5.2V, -8V, -18V, -20V
- Contact factory for other voltage options

HIGH RELIABILITY FEATURES - SG120

- ◆ Available to MIL-STD - 883
- ◆ Radiation data available
- ◆ LMI level "S" processing available

SCHEMATIC DIAGRAM

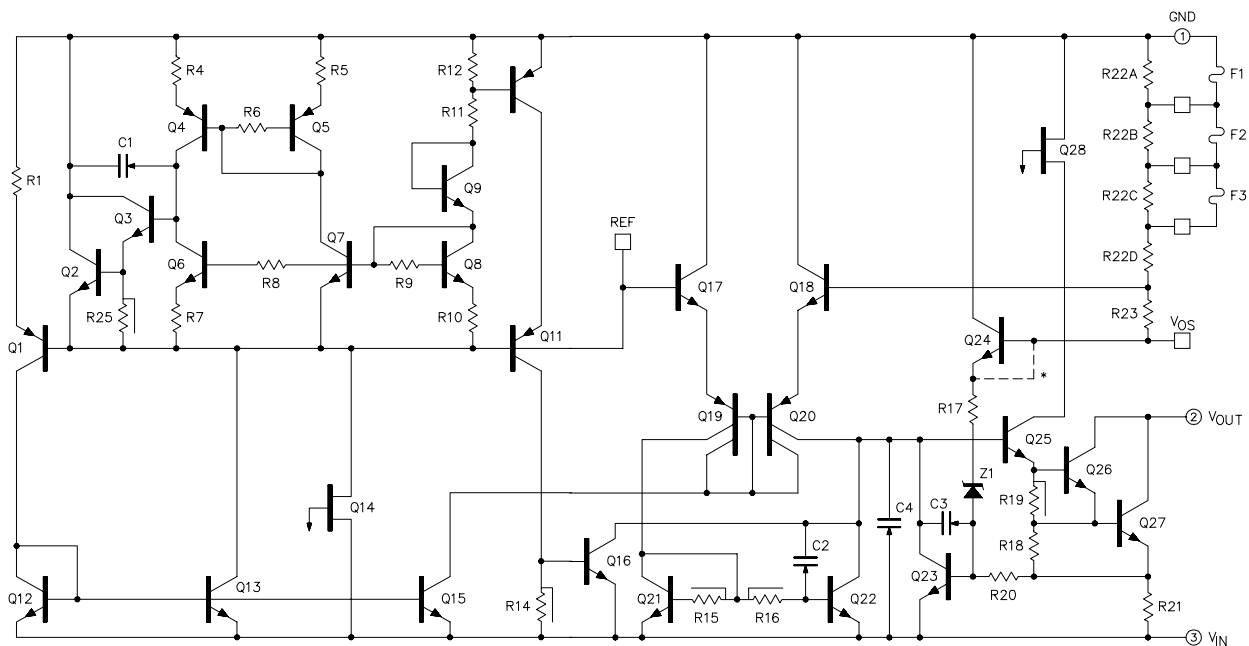

* WIRE EXISTS IF 120 TYPE DEVICE.
WIRE DOES NOT EXIST IF 7900 TYPE DEVICE.
SELECTABLE BY EMITTER OPTION.

ABSOLUTE MAXIMUM RATINGS (Note 1)

Device Output Voltage	Input Voltage	Input Voltage Differential (Output shorted to ground)
-5V	-35V	35V
-5.2V	-35V	35V
-8V	-35V	35V
-12V	-35V	35V
-15V	-40V	35V
-18V	-40V	35V
-20V	-40V	35V

Operating Junction Temperature
 Hermetic (K, R, IG - Packages) 150°C

Storage Temperature Range -65°C to 150°C
 Lead Temperature (Soldering, 10 Seconds) 300°C

Note 1. Values beyond which damage may occur.

THERMAL DATA

K Package:

Thermal Resistance-Junction to Case, θ_{JC} 3.0°C/W
 Thermal Resistance-Junction to Ambient, θ_{JA} 35°C/W

R Package:

Thermal Resistance-Junction to Case, θ_{JC} 5.0°C/W
 Thermal Resistance-Junction to Ambient, θ_{JA} 40°C/W

T Package:

Thermal Resistance-Junction to Case, θ_{JC} 15°C/W
 Thermal Resistance-Junction to Ambient, θ_{JA} 120°C/W

IG Package:

Thermal Resistance-Junction to Case, θ_{JC} 3.5°C/W
 Thermal Resistance-Junction to Ambient, θ_{JA} 42°C/W

L Package:

Thermal Resistance-Junction to Case, θ_{JC} 35°C/W
 Thermal Resistance-Junction to Ambient, θ_{JA} 120°C/W

Note A. Junction Temperature Calculation: $T_J = T_A + (P_D \times \theta_{JA})$.

Note B. The above numbers for θ_{JC} are maximums for the limiting thermal resistance of the package in a standard mounting configuration. The θ_{JA} numbers are meant to be guidelines for the thermal performance of the device/pc-board system. All of the above assume no ambient airflow.

RECOMMENDED OPERATING CONDITIONS (Note 2)

Operating Junction Temperature Range:
 SG120 -55°C to 150°C

Note 2. Range over which the device is functional.

CHARACTERISTIC CURVES

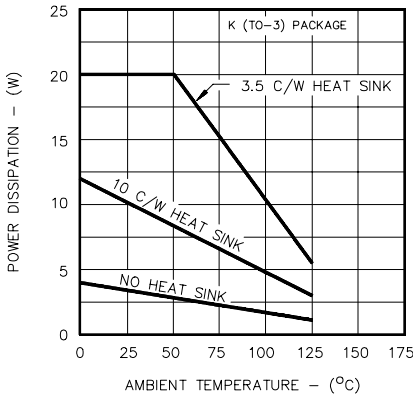

FIGURE 1. MAXIMUM AVERAGE POWER DISSIPATION

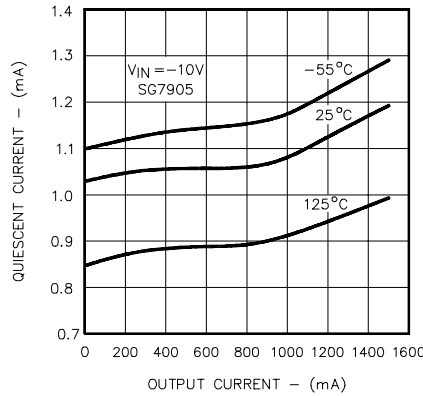

FIGURE 2. QUIESCIENT CURRENT VS. LOAD

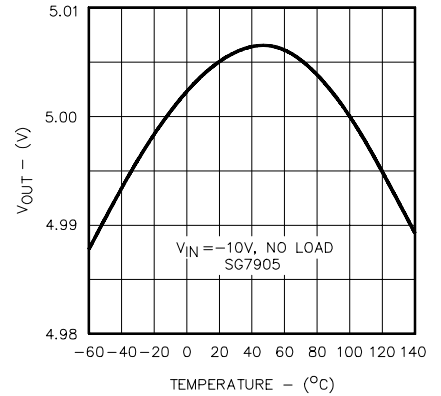

FIGURE 3. TEMPERATURE COEFFICIENT

CHARACTERISTIC CURVES (continued)

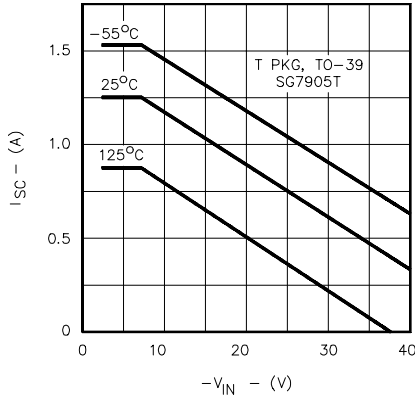

FIGURE 4. SHORTCIRCUIT CURRENT VS. V_{IN}

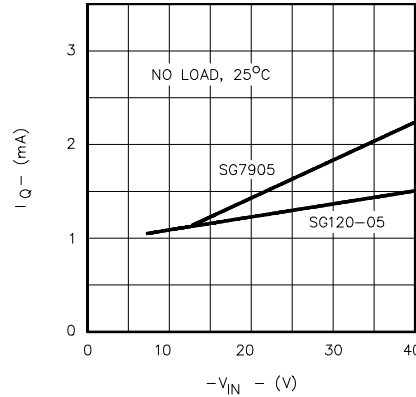

FIGURE 5. QUIESCENT CURRENT VS. V_{IN}

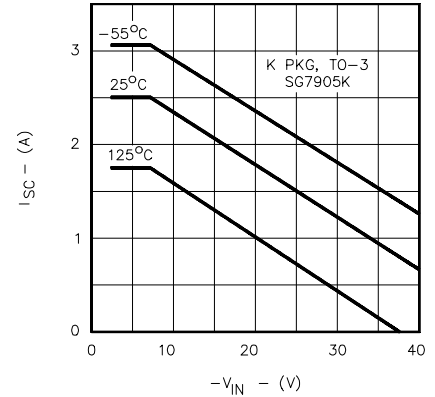

FIGURE 6. SHORT CIRCUIT CURRENT VS. V_{IN}

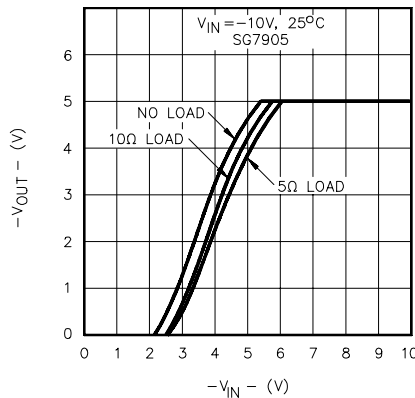

FIGURE 7. DROPOUT CHARACTERISTICS

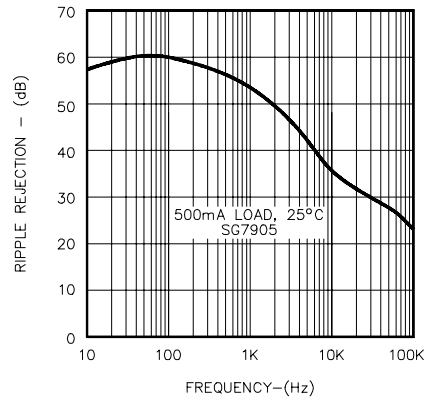

FIGURE 8. RIPPLE REJECTION VS. FREQUENCY

APPLICATIONS

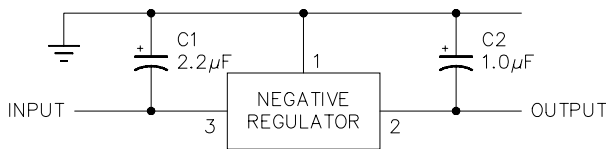

FIGURE 9 - FIXED OUTPUT REGULATOR

- NOTE: 1. C1 is required only if regulator is separated from rectifier filter.
 2. Both C1 and C2 should be low E.S.R. types such as solid tantalum. If aluminum electrolytics are used, at least 10 times values shown should be selected.
 3. If large output capacities are used, the regulators must be protected from momentary input shorts. A high current diode from output to input will suffice.

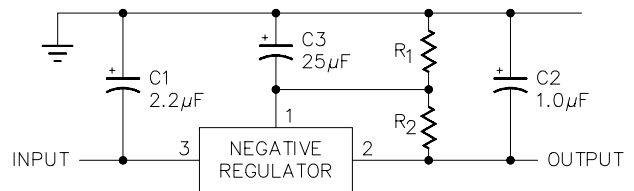

FIGURE 10 - CIRCUIT FOR INCREASING OUTPUT VOLTAGE

- NOTE: C3 optional for improved transient response and ripple rejection.

$$V_{OUT} = V(\text{REGULATOR}) \frac{R_1 + R_2}{R_1} \quad R_2 = \frac{V(\text{REG})}{15\text{mA}}$$

ELECTRICAL CHARACTERISTICS (Note 1)**SG120-05**

(Unless otherwise specified, these specifications apply over full operating ambient temperatures for SG120-05 with $-55^{\circ}\text{C} \leq T_A \leq 150^{\circ}\text{C}$, and $V_{IN} = -10\text{V}$, $I_O = 5\text{mA}$, $C_{IN} = 2\text{mF}$, $C_{OUT} = 1.0\text{mF}$. Low duty cycle pulse testing techniques are used which maintains junction and case temperature equal to the ambient temperature.)

Parameter	Test Conditions	SG120-05			Units
		Min.	Typ.	Max.	
Output Voltage	$T_J = 25^{\circ}\text{C}$	-4.9	-5.0	-5.1	V
Line Regulation (Note 1)	$V_{IN} = -7\text{V to } -25\text{V}$, $T_J = 25^{\circ}\text{C}$		10	25	mV
Load Regulation (Note 1)	Power Pkgs: $I_O = 5\text{mA to } 1.5\text{A}$, $T_J = 25^{\circ}\text{C}$		50	75	mV
	T - Pkg: $I_O = 500\text{mA}$, $T_J = 25^{\circ}\text{C}$		30	50	mV
Total Output Voltage	$V_{IN} = -7.5\text{V to } -25\text{V}$				
Tolerance	Power Pkgs: $I_O = 5\text{mA to } 1.5\text{A}$, $P \leq 20\text{W}$	-4.8	-5.0	-5.2	V
	T - Pkg: $I_O = 5\text{mA to } 500\text{mA}$, $P \leq 2\text{W}$	-4.8	-5.0	-5.2	V
Quiescent Current	$V_{IN} = -7\text{V to } -25\text{V}$			2	mA
Quiescent Current Change	With Line: $V_{IN} = -7\text{V to } -25\text{V}$, $T_J = 25^{\circ}\text{C}$			0.4	mA
	With Load: $T_J = 25^{\circ}\text{C}$				
	Power Pkgs: $I_O = 5\text{mA to } 1.5\text{A}$			0.4	mA
	T - Pkg: $I_O = 5\text{mA to } 500\text{mA}$			0.4	mA
Dropout Voltage	$\Delta V_O = 100\text{mV}$, $T_J = 25^{\circ}\text{C}$				
	Power Pkgs: $I_O = 1.0\text{A}$, T - Pkg: $I_O = 500\text{mA}$		1.1	2.3	V
Peak Output Current	Power Pkgs: $T_J = 25^{\circ}\text{C}$	1.5		3.3	A
	T - Pkg: $T_J = 25^{\circ}\text{C}$	0.5		1.4	A
Short Circuit Current	Power Pkgs: $V_{IN} = -35\text{V}$, $T_J = 25^{\circ}\text{C}$			1.2	A
	T - Pkg: $V_{IN} = -35\text{V}$, $T_J = 25^{\circ}\text{C}$			0.6	A
Ripple Rejection	$\Delta V_{IN} = 10\text{V}$, $f = 120\text{Hz}$, $T_J = 25^{\circ}\text{C}$	54			dB
Output Noise Voltage (rms)	$f = 10\text{Hz to } 100\text{KHz}$ (Note 2)		25	80	$\mu\text{V/V}$
Long Term Stability	1000hrs. at $T_J = 125^{\circ}\text{C}$		20		mV
Thermal Shutdown	$I_O = 5\text{mA}$		175		$^{\circ}\text{C}$

SG120-5.2

(Unless otherwise specified, these specifications apply over full operating ambient temperatures for SG120-5.2 with $-55^{\circ}\text{C} \leq T_A \leq 150^{\circ}\text{C}$, and $V_{IN} = -10\text{V}$, $I_O = 5\text{mA}$, $C_{IN} = 2\text{mF}$, $C_{OUT} = 1.0\text{mF}$. Low duty cycle pulse testing techniques are used which maintains junction and case temperature equal to the ambient temperature.)

Parameter	Test Conditions	SG120-5.2			Units
		Min.	Typ.	Max.	
Output Voltage	$T_J = 25^{\circ}\text{C}$	-5.1	-5.2	-5.3	V
Line Regulation (Note 1)	$V_{IN} = -7.2\text{V to } -25\text{V}$, $T_J = 25^{\circ}\text{C}$		15	25	mV
Load Regulation (Note 1)	Power Pkgs: $I_O = 5\text{mA to } 1.5\text{A}$, $T_J = 25^{\circ}\text{C}$		50	75	mV
	T - Pkg: $I_O = 500\text{mA}$, $T_J = 25^{\circ}\text{C}$		30	50	mV
Total Output Voltage	$V_{IN} = -7.7\text{V to } -25\text{V}$				
Tolerance	Power Pkgs: $I_O = 5\text{mA to } 1.5\text{A}$, $P \leq 20\text{W}$	-5.0	-5.2	-5.4	V
	T - Pkg: $I_O = 5\text{mA to } 500\text{mA}$, $P \leq 2\text{W}$	-5.0	-5.2	-5.4	V
Quiescent Current	$V_{IN} = -7.2\text{V to } -25\text{V}$			2	mA
Quiescent Current Change	With Line: $V_{IN} = -7.2\text{V to } -25\text{V}$, $T_J = 25^{\circ}\text{C}$			0.4	mA
	With Load: $T_J = 25^{\circ}\text{C}$				
	Power Pkgs: $I_O = 5\text{mA to } 1.5\text{A}$			0.4	mA
	T - Pkg: $I_O = 5\text{mA to } 500\text{mA}$			0.4	mA
Dropout Voltage	$\Delta V_O = 100\text{mV}$, $T_J = 25^{\circ}\text{C}$				
	Power Pkgs: $I_O = 1.5\text{A}$, T - Pkg: $I_O = 500\text{mA}$		1.1	2.3	V
Peak Output Current	Power Pkgs: $T_J = 25^{\circ}\text{C}$	1.5		3.3	A
	T - Pkg: $T_J = 25^{\circ}\text{C}$	0.5		1.4	A
Short Circuit Current	Power Pkgs: $V_{IN} = -35\text{V}$, $T_J = 25^{\circ}\text{C}$			1.2	A
	T - Pkg: $V_{IN} = -35\text{V}$, $T_J = 25^{\circ}\text{C}$			0.6	A
Ripple Rejection	$\Delta V_{IN} = 10\text{V}$, $f = 120\text{Hz}$, $T_J = 25^{\circ}\text{C}$	54			dB
Output Noise Voltage (rms)	$f = 10\text{Hz to } 100\text{KHz}$ (Note 2)		25	80	$\mu\text{V/V}$
Long Term Stability	1000hrs. at $T_J = 125^{\circ}\text{C}$		20		mV
Thermal Shutdown	$I_O = 5\text{mA}$		175		$^{\circ}\text{C}$

Note 1. All regulation tests are made at constant junction temperature with low duty cycle testing.
2. This test is guaranteed but is not tested in production.

ELECTRICAL CHARACTERISTICS (Note 1)**SG120-08**

(Unless otherwise specified, these specifications apply over full operating ambient temperatures for SG120-08 with $-55^{\circ}\text{C} \leq T_A \leq 150^{\circ}\text{C}$, and $V_{IN} = -14\text{V}$, $I_O = 5\text{mA}$, $C_{IN} = 1.0\text{mF}$, $C_{OUT} = 1.0\text{mF}$. Low duty cycle pulse testing techniques are used which maintains junction and case temperature equal to the ambient temperature.)

Parameter	Test Conditions	SG120-8			Units
		Min.	Typ.	Max.	
Output Voltage	$T_J = 25^{\circ}\text{C}$	-7.8	-8.0	-8.2	V
Line Regulation (Note 1)	$V_{IN} = -10.5\text{V to } -25\text{V}$, $T_J = 25^{\circ}\text{C}$		10	25	mV
Load Regulation (Note 1)	Power Pkgs: $I_O = 5\text{mA to } 1.5\text{A}$, $T_J = 25^{\circ}\text{C}$		20	80	mV
	T - Pkg: $I_O = 5\text{mA to } 500\text{mA}$, $T_J = 25^{\circ}\text{C}$		10	25	mV
Total Output Voltage	$V_{IN} = -10.5\text{V to } -25\text{V}$				
Tolerance	Power Pkgs: $I_O = 5\text{mA to } 1.5\text{A}$, $P \leq 20\text{W}$	-7.65	-8.00	-8.35	V
	T - Pkg: $I_O = 5\text{mA to } 500\text{mA}$, $P \leq 2\text{W}$	-7.65	-8.00	-8.35	V
Quiescent Current	$V_{IN} = -10.5\text{V to } -25\text{V}$			2	mA
Quiescent Current Change	With Line: $V_{IN} = -10.5\text{V to } -25\text{V}$, $T_J = 25^{\circ}\text{C}$			0.4	mA
	With Load: $T_J = 25^{\circ}\text{C}$				
Dropout Voltage	Power Pkgs: $I_O = 5\text{mA to } 1.5\text{A}$			0.4	mA
	T - Pkg: $I_O = 5\text{mA to } 500\text{mA}$			0.4	mA
Peak Output Current	$\Delta V_O = 100\text{mV}$, $T_J = 25^{\circ}\text{C}$		1.1	2.3	V
	Power Pkgs: $I_O = 1.0\text{A}$, T - Pkg: $I_O = 500\text{mA}$				
Short Circuit Current	Power Pkgs: $T_J = 25^{\circ}\text{C}$	1.5		3.3	A
	T - Pkg: $T_J = 25^{\circ}\text{C}$	0.5		1.4	A
Ripple Rejection	Power Pkgs: $V_{IN} = -35\text{V}$, $T_J = 25^{\circ}\text{C}$			1.2	A
	T - Pkg: $V_{IN} = -35\text{V}$, $T_J = 25^{\circ}\text{C}$			0.6	A
Output Noise Voltage (rms)	$\Delta V_{IN} = 10\text{V}$, $f = 120\text{Hz}$, $T_J = 25^{\circ}\text{C}$	54			dB
Long Term Stability	$f = 10\text{Hz to } 100\text{KHz}$ (Note 2)		25	80	$\mu\text{V/V}$
Thermal Shutdown	1000hrs. at $T_J = 125^{\circ}\text{C}$		32		mV
	$I_O = 5\text{mA}$		175		$^{\circ}\text{C}$

SG120-12

(Unless otherwise specified, these specifications apply over full operating ambient temperatures for SG120-12 with $-55^{\circ}\text{C} \leq T_A \leq 150^{\circ}\text{C}$, and $V_{IN} = -17\text{V}$, $I_O = 5\text{mA}$, $C_{IN} = 2.0\text{mF}$, $C_{OUT} = 1.0\text{mF}$. Low duty cycle pulse testing techniques are used which maintains junction and case temperature equal to the ambient temperature.)

Parameter	Test Conditions	SG120-12			Units
		Min.	Typ.	Max.	
Output Voltage	$T_J = 25^{\circ}\text{C}$	-11.7	-12.0	-12.3	V
Line Regulation (Note 1)	$V_{IN} = -14\text{V to } -32\text{V}$, $T_J = 25^{\circ}\text{C}$		4	10	mV
Load Regulation (Note 1)	Power Pkgs: $I_O = 5\text{mA to } 1.0\text{A}$, $T_J = 25^{\circ}\text{C}$		30	80	mV
	T - Pkg: $I_O = 5\text{mA to } 500\text{mA}$, $T_J = 25^{\circ}\text{C}$		10	25	mV
Total Output Voltage	$V_{IN} = -14.5\text{V to } -32\text{V}$				
Tolerance	Power Pkgs: $I_O = 5\text{mA to } 1.0\text{A}$, $P \leq 20\text{W}$	-11.5	-12.0	-12.5	V
	T - Pkg: $I_O = 5\text{mA to } 500\text{mA}$, $P \leq 2\text{W}$	-11.5	-12.0	-12.5	V
Quiescent Current	$V_{IN} = -14\text{V to } -32\text{V}$		2	4	mA
Quiescent Current Change	With Line: $V_{IN} = -14\text{V to } -32\text{V}$, $T_J = 25^{\circ}\text{C}$			0.4	mA
	With Load: $T_J = 25^{\circ}\text{C}$				
Dropout Voltage	Power Pkgs: $I_O = 5\text{mA to } 1.0\text{A}$			0.4	mA
	T - Pkg: $I_O = 5\text{mA to } 500\text{mA}$			0.4	mA
Peak Output Current	$\Delta V_O = 100\text{mV}$, $T_J = 25^{\circ}\text{C}$		1.1	2.3	V
	Power Pkgs: $I_O = 1.0\text{A}$, T - Pkg: $I_O = 500\text{mA}$				
Short Circuit Current	Power Pkgs: $T_J = 25^{\circ}\text{C}$	1.5		3.3	A
	T - Pkg: $T_J = 25^{\circ}\text{C}$	0.5		1.4	A
Ripple Rejection	Power Pkgs: $V_{IN} = -35\text{V}$, $T_J = 25^{\circ}\text{C}$			1.2	A
	T - Pkg: $V_{IN} = -35\text{V}$, $T_J = 25^{\circ}\text{C}$			0.6	A
Output Noise Voltage (rms)	$\Delta V_{IN} = 10\text{V}$, $f = 120\text{Hz}$, $T_J = 25^{\circ}\text{C}$	56			dB
Long Term Stability	$f = 10\text{Hz to } 100\text{KHz}$ (Note 2)		25	80	$\mu\text{V/V}$
Thermal Shutdown	1000hrs. at $T_J = 125^{\circ}\text{C}$		48		mV
	$I_O = 5\text{mA}$		175		$^{\circ}\text{C}$

Note 1. All regulation tests are made at constant junction temperature with low duty cycle testing.

2. This test is guaranteed but is not tested in production.

ELECTRICAL CHARACTERISTICS (Note 1)**SG120-15**

(Unless otherwise specified, these specifications apply over full operating ambient temperatures for SG120-15 with $-55^{\circ}\text{C} \leq T_A \leq 150^{\circ}\text{C}$, and $V_{IN} = -20\text{V}$, $I_O = 5\text{mA}$, $C_{IN} = 2.0\text{mF}$, $C_{OUT} = 1.0\text{mF}$. Low duty cycle pulse testing techniques are used which maintains junction and case temperature equal to the ambient temperature.)

Parameter	Test Conditions	SG120-15			Units
		Min.	Typ.	Max.	
Output Voltage	$T_J = 25^{\circ}\text{C}$	-14.7	-15.0	-15.3	V
Line Regulation (Note 1)	$V_{IN} = -17\text{V}$ to -35V , $T_J = 25^{\circ}\text{C}$		5	10	mV
Load Regulation (Note 1)	Power Pkgs: $I_O = 5\text{mA}$ to 1.0A , $T_J = 25^{\circ}\text{C}$		30	80	mV
	T - Pkg: $I_O = 5\text{mA}$ to 500mA , $T_J = 25^{\circ}\text{C}$		10	25	mV
Total Output Voltage	$V_{IN} = -17.5\text{V}$ to -35V				
Tolerance	Power Pkgs: $I_O = 5\text{mA}$ to 1.0A , $P \leq 20\text{W}$	-14.5	-15.0	-15.5	V
	T - Pkg: $I_O = 5\text{mA}$ to 500mA , $P \leq 2\text{W}$	-14.5	-15.0	-15.5	V
Quiescent Current	$V_{IN} = -17\text{V}$ to -35V		2	4	mA
Quiescent Current Change	With Line: $V_{IN} = -17\text{V}$ to -35V , $T_J = 25^{\circ}\text{C}$			0.4	mA
	With Load: $T_J = 25^{\circ}\text{C}$				
Dropout Voltage	Power Pkgs: $I_O = 5\text{mA}$ to 1.0A			0.4	mA
	T - Pkg: $I_O = 5\text{mA}$ to 500mA			0.4	mA
Peak Output Current	$\Delta V_O = 100\text{mV}$, $T_J = 25^{\circ}\text{C}$		1.1	2.3	V
	Power Pkgs: $I_O = 1.0\text{A}$, T - Pkg: $I_O = 500\text{mA}$				
Short Circuit Current	Power Pkgs: $T_J = 25^{\circ}\text{C}$	1.5		3.3	A
	T - Pkg: $T_J = 25^{\circ}\text{C}$	0.5		1.4	A
Ripple Rejection	Power Pkgs: $V_{IN} = -35\text{V}$, $T_J = 25^{\circ}\text{C}$			1.2	A
	T - Pkg: $V_{IN} = -35\text{V}$, $T_J = 25^{\circ}\text{C}$			0.6	A
Output Noise Voltage (rms)	$\Delta V_{IN} = 10\text{V}$, $f = 120\text{Hz}$, $T_J = 25^{\circ}\text{C}$	56			dB
Long Term Stability	$f = 10\text{Hz}$ to 100KHz (Note 2)		25	80	$\mu\text{V/V}$
Thermal Shutdown	1000hrs. at $T_J = 125^{\circ}\text{C}$		60		mV
	$I_O = 5\text{mA}$		175		$^{\circ}\text{C}$

SG120-18

(Unless otherwise specified, these specifications apply over full operating ambient temperatures for SG120-18 with $-55^{\circ}\text{C} \leq T_A \leq 150^{\circ}\text{C}$, and $V_{IN} = -27\text{V}$, $I_O = 5\text{mA}$, $C_{IN} = 2.0\text{mF}$, $C_{OUT} = 1.0\text{mF}$. Low duty cycle pulse testing techniques are used which maintains junction and case temperature equal to the ambient temperature.)

Parameter	Test Conditions	SG120-18			Units
		Min.	Typ.	Max.	
Output Voltage	$T_J = 25^{\circ}\text{C}$	-17.6	-18.0	-18.4	V
Line Regulation (Note 1)	$V_{IN} = -21\text{V}$ to -33V , $T_J = 25^{\circ}\text{C}$		5	10	mV
Load Regulation (Note 1)	Power Pkgs: $I_O = 5\text{mA}$ to 1.0A , $T_J = 25^{\circ}\text{C}$		30	80	mV
	T - Pkg: $I_O = 5\text{mA}$ to 500mA , $T_J = 25^{\circ}\text{C}$		10	25	mV
Total Output Voltage	$V_{IN} = -22\text{V}$ to -33V				
Tolerance	Power Pkgs: $I_O = 5\text{mA}$ to 1.0A , $P \leq 20\text{W}$	-17.4	-18.0	-18.6	V
	T - Pkg: $I_O = 5\text{mA}$ to 500mA , $P \leq 2\text{W}$	-17.4	-18.0	-18.6	V
Quiescent Current	$V_{IN} = -21\text{V}$ to -33V		2	4	mA
Quiescent Current Change	With Line: $V_{IN} = -21\text{V}$ to -33V , $T_J = 25^{\circ}\text{C}$			0.4	mA
	With Load: $T_J = 25^{\circ}\text{C}$				
Dropout Voltage	Power Pkgs: $I_O = 5\text{mA}$ to 1.0A			0.4	mA
	T - Pkg: $I_O = 5\text{mA}$ to 500mA			0.4	mA
Peak Output Current	$\Delta V_O = 100\text{mV}$, $T_J = 25^{\circ}\text{C}$		1.1	2.3	V
	Power Pkgs: $I_O = 1.0\text{A}$, T - Pkg: $I_O = 500\text{mA}$				
Short Circuit Current	Power Pkgs: $T_J = 25^{\circ}\text{C}$	1.5		3.3	A
	T - Pkg: $T_J = 25^{\circ}\text{C}$	0.5		1.4	A
Ripple Rejection	Power Pkgs: $V_{IN} = -35\text{V}$, $T_J = 25^{\circ}\text{C}$			1.2	A
	T - Pkg: $V_{IN} = -35\text{V}$, $T_J = 25^{\circ}\text{C}$			0.6	A
Output Noise Voltage (rms)	$\Delta V_{IN} = 10\text{V}$, $f = 120\text{Hz}$, $T_J = 25^{\circ}\text{C}$	56			dB
Long Term Stability	$f = 10\text{Hz}$ to 100KHz (Note 2)		25		$\mu\text{V/V}$
Thermal Shutdown	1000hrs. at $T_J = 125^{\circ}\text{C}$		72		mV
	$I_O = 5\text{mA}$		175		$^{\circ}\text{C}$

Note 1. All regulation tests are made at constant junction temperature with low duty cycle testing.

2. This test is guaranteed but is not tested in production.

ELECTRICAL CHARACTERISTICS (Note 1)**SG120-20**

(Unless otherwise specified, these specifications apply over full operating ambient temperatures for SG120-20 with $-55^{\circ}\text{C} \leq T_A \leq 150^{\circ}\text{C}$, and $V_{IN} = -29\text{V}$, $I_O = 5\text{mA}$, $C_{IN} = 2.0\text{mF}$, $C_{OUT} = 1.0\text{mF}$. Low duty cycle pulse testing techniques are used which maintains junction and case temperature equal to the ambient temperature.)

Parameter	Test Conditions	SG120-20			Units
		Min.	Typ.	Max.	
Output Voltage	$T_J = 25^{\circ}\text{C}$	-19.5	-20.0	-20.5	V
Line Regulation (Note 1)	$V_{IN} = -23\text{V}$ to -35V , $T_J = 25^{\circ}\text{C}$		5	10	mV
Load Regulation (Note 1)	Power Pkgs: $I_O = 5\text{mA}$ to 1.0A , $T_J = 25^{\circ}\text{C}$		30	80	mV
	T - Pkg: $I_O = 5\text{mA}$ to 500mA , $T_J = 25^{\circ}\text{C}$		10	25	mV
Total Output Voltage Tolerance	$V_{IN} = -24\text{V}$ to -35V Power Pkgs: $I_O = 5\text{mA}$ to 1.0A , $P \leq 20\text{W}$ T - Pkg: $I_O = 5\text{mA}$ to 500mA , $P \leq 2\text{W}$	-19.3	-20.0	-20.7	V
Quiescent Current	$V_{IN} = -23\text{V}$ to -35V		2	4	mA
Quiescent Current Change	With Line: $V_{IN} = -23\text{V}$ to -35V , $T_J = 25^{\circ}\text{C}$			0.4	mA
	With Load: $T_J = 25^{\circ}\text{C}$				
	Power Pkgs: $I_O = 5\text{mA}$ to 1.0A T - Pkg: $I_O = 5\text{mA}$ to 500mA			0.4	mA
Dropout Voltage	$\Delta V_O = 100\text{mV}$, $T_J = 25^{\circ}\text{C}$				
	Power Pkgs: $I_O = 1.0\text{A}$, T - Pkg: $I_O = 500\text{mA}$		1.1	2.3	V
Peak Output Current	Power Pkgs: $T_J = 25^{\circ}\text{C}$	1.5		3.3	A
	T - Pkg: $T_J = 25^{\circ}\text{C}$	0.5		1.4	A
Short Circuit Current	Power Pkgs: $V_{IN} = -35\text{V}$, $T_J = 25^{\circ}\text{C}$			1.2	A
	T - Pkg: $V_{IN} = -35\text{V}$, $T_J = 25^{\circ}\text{C}$			0.6	A
Ripple Rejection	$\Delta V_{IN} = 10\text{V}$, $f = 120\text{Hz}$, $T_J = 25^{\circ}\text{C}$	56			dB
Output Noise Voltage (rms)	$f = 10\text{Hz}$ to 100KHz (Note 2)		25	80	$\mu\text{V}/\text{V}$
Long Term Stability	1000hrs. at $T_J = 125^{\circ}\text{C}$		80		mV
Thermal Shutdown	$I_O = 5\text{mA}$		175		$^{\circ}\text{C}$

Note 1. All regulation tests are made at constant junction temperature with low duty cycle testing.

2. This test is guaranteed but is not tested in production.

CONNECTION DIAGRAMS & ORDERING INFORMATION (See Notes Below)

Package	Part No.	Ambient Temperature Range	Connection Diagram
3-TERMINAL TO-3 METAL CAN K-PACKAGE	SG120-XXK/883B SG120-XXK	-55°C to 125°C -55°C to 125°C	
3-TERMINAL TO-66 METAL CAN R-PACKAGE	SG120-XXR/883B SG120-XXR	-55°C to 125°C -55°C to 125°C	
3-PIN TO-39 METAL CAN T-PACKAGE	SG120-XXT/883B SG120-XXT	-55°C to 125°C -55°C to 125°C	
3-PIN HERMETIC TO-257 IG-PACKAGE (Isolated)	SG120-XXIG/883B SG120-XXIG	-55°C to 125°C -55°C to 125°C	
20-PIN CERAMIC (LCC) LEADLESS CHIP CARRIER L- PACKAGE	SG120-XXL/883B SG120-XXL	-55°C to 125°C -55°C to 125°C	(Note 4) <div style="display: flex; justify-content: space-between;"> <div style="width: 45%;"> <p>1. N.C. 2. V_{IN} 3. N.C. 4. V_{OUT} 5. V_{OUT} 6. N.C. 7. V_{OUT} SENSE 8. N.C. 9. N.C. 10. N.C.</p> </div> <div style="width: 45%;"> <p>11. N.C. 12. N.C. 13. N.C. 14. N.C. 15. GND 16. N.C. 17. GND 18. N.C. 19. N.C. 20. V_{IN}</p> </div> </div>

- Note 1. Contact factory for JAN and DESC product availability.
 2. All parts are viewed from the top.
 3. "XX" to be replaced by output voltage of specific fixed regulator.
 4. Some products will be available in leadless chip carrier (LCC) and hermetic flat pack (F). Consult factory for price and availability