

NPN SILICON EPITAXIAL TRANSISTOR
POWER MINI MOLD

DESCRIPTION

The 2SC2954 is an NPN epitaxial silicon transistor designed for low noise wide band amplifier and buffer amplifier of OSC, for VHF and CATV band.

FEATURES

- Low Noise and High Gain.
 $f = 200 \text{ MHz}, 500 \text{ MHz}$
 $NF: 2.3 \text{ dB}, 2.4 \text{ dB}$
 $|S_{21e}|: 20 \text{ dB}, 12.5 \text{ dB}$
- Large P_T in Small Package.
 $P_T: 2 \text{ W}$ with $16 \text{ cm}^2 \times 0.7 \text{ mm}$ Ceramic Substrate.

ABSOLUTE MAXIMUM RATINGS ($T_A = 25 \text{ }^\circ\text{C}$)

Collector to Base Voltage	V_{CBO}	35	V
Collector to Emitter Voltage	V_{CEO}	18	V
Emitter to Base Voltage	V_{EBO}	3.0	V
Collector Current	I_C	150	mA
Total Power Dissipation	P_T^*	2.0	W
Thermal Resistance	$R_{th(j-a)}^*$	62.5	$^\circ\text{C/W}$
Junction Temperature	T_j	150	$^\circ\text{C}$
Storage Temperature	T_{stg}	-65 to +150	$^\circ\text{C}$

* With $16 \text{ cm}^2 \times 0.7 \text{ mm}$
Ceramic Substrate

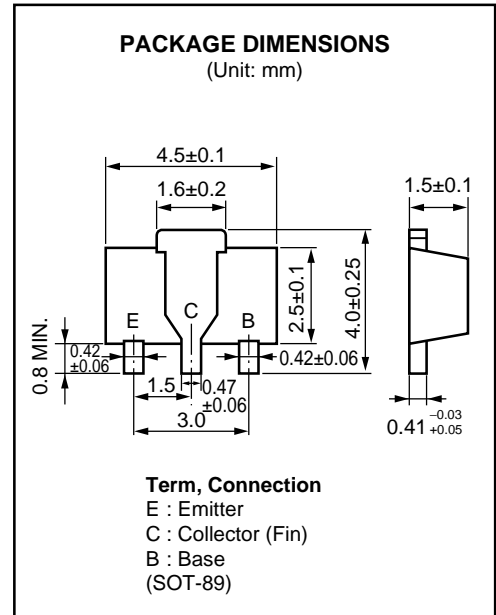

ELECTRICAL CHARACTERISTICS (T_A = 25 °C)

CHARACTERISTIC	SYMBOL	TEST CONDITIONS	MIN.	TYP.	MAX.	UNIT
Collector Cutoff Current	I _{CB0}	V _{CB} = 10 V, I _E = 0			100	nA
DC Current Gain	h _{FE}	V _{CE} = 10 V, I _C = 50 mA *1	30	100	200	-
Gain Bandwidth Product	f _T	V _{CE} = 10 V, I _C = 50 mA	3.0	4.0		GHz
Feedback Capacitance	C _{re}	V _{CB} = 10 V, Emitter Grounded, f = 1.0 MHz		1.1	1.8	pF
Insertion Power Gain	S _{21e} ²	V _{CE} = 10 V, I _C = 50 mA, f = 500 MHz R _G = 50 Ω	10	12.5		dB
Noise Figure	NF	V _{CE} = 10 V, I _C = 30 mA, f = 500 MHz R _G = 50 Ω		2.4	4.0	dB

*1 Pulse Measurement PW ≤ 350 μs, duty cycle 2 %/Pulsed

TYPICAL CHARACTERISTICS (T_A = 25 °C)

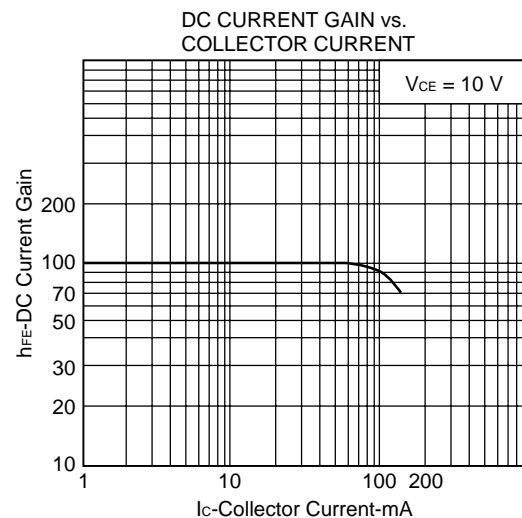
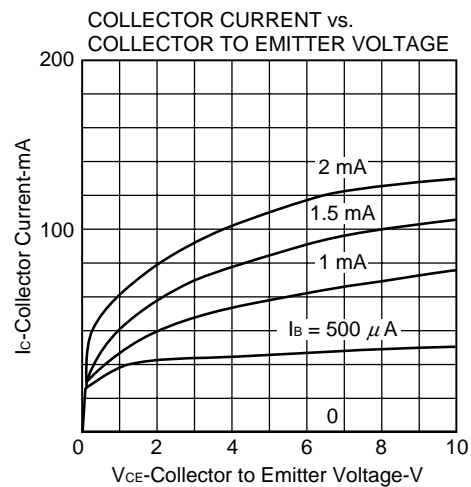
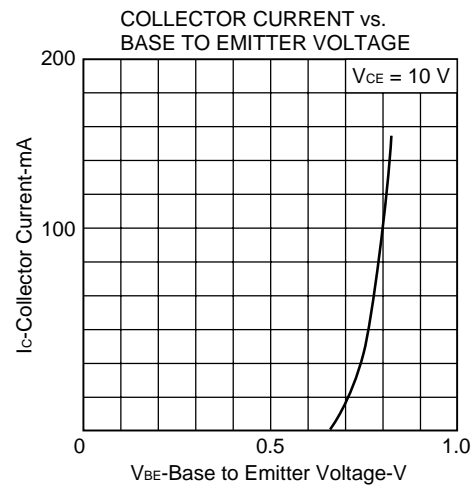
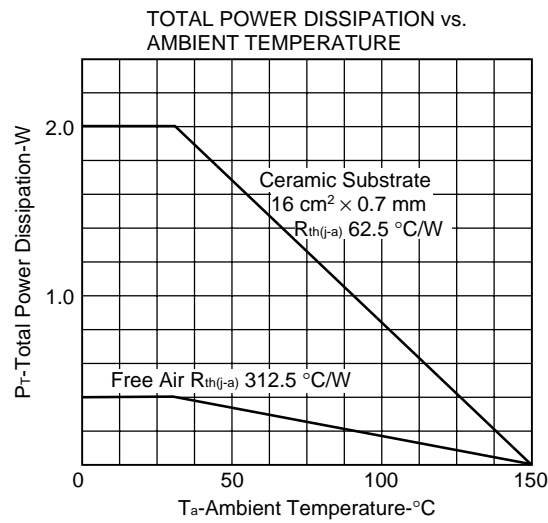

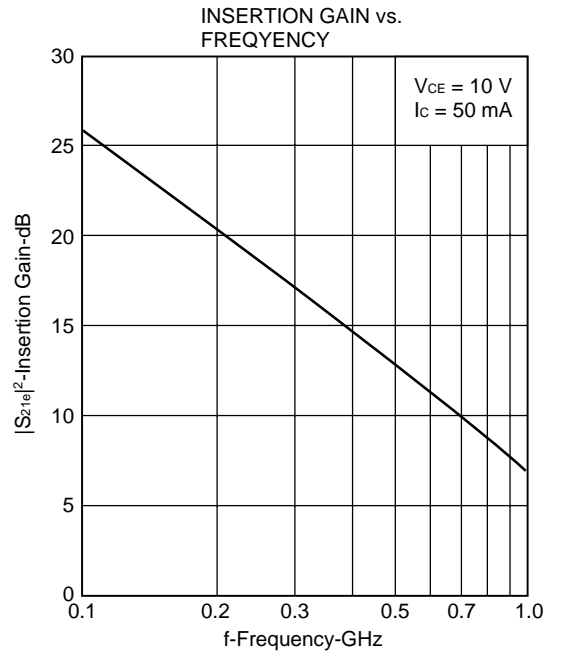
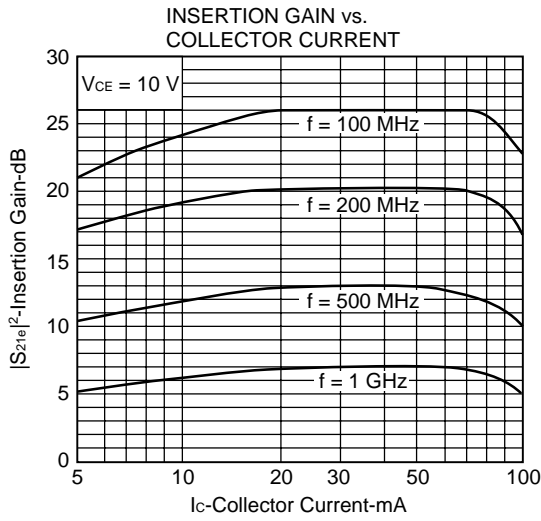
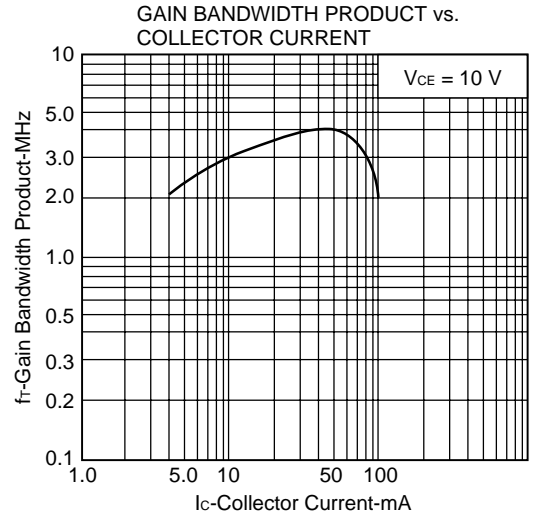
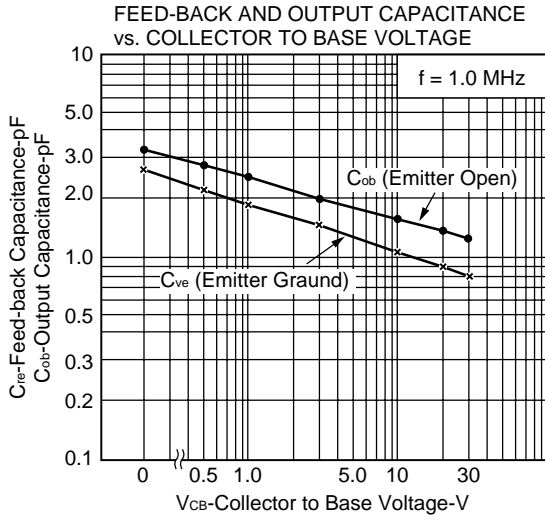

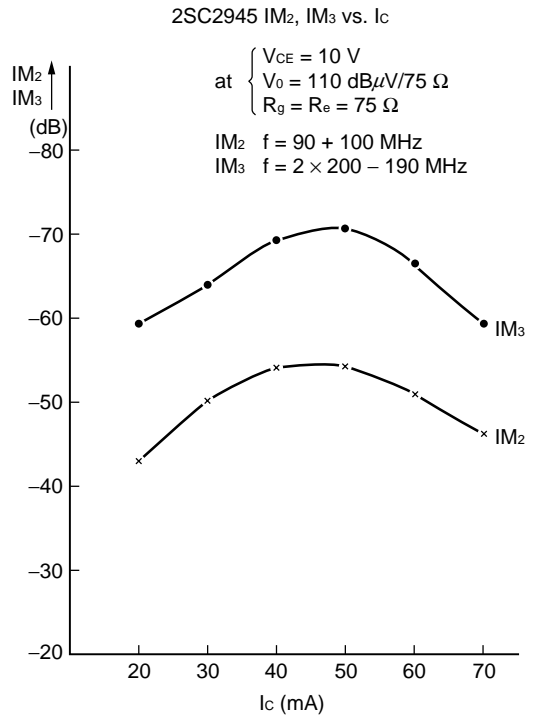
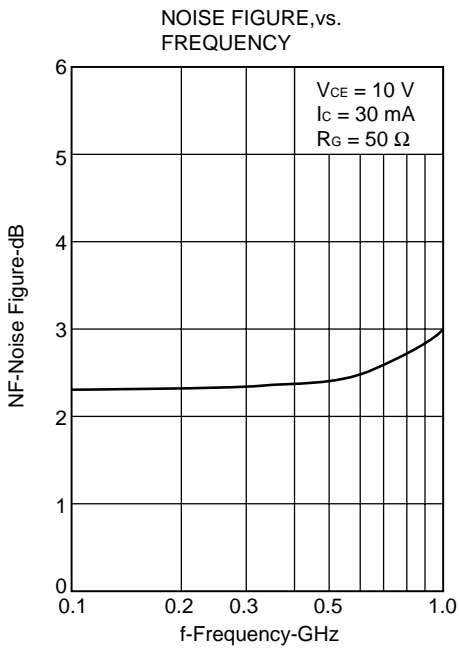
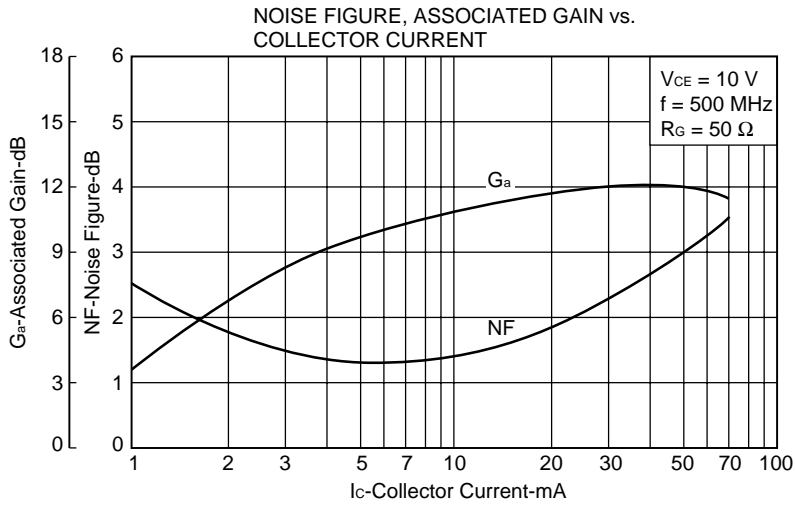

S_{11e}, S_{22e}-FREQUENCY

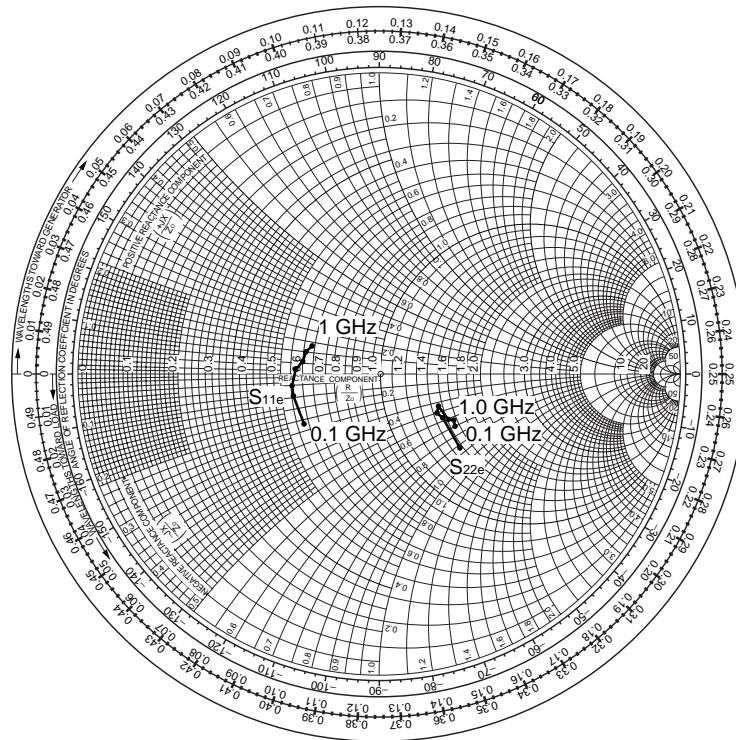

CONDITION $V_{CE} = 10\text{ V}$
 $I_C = 50\text{ mA}$
 $f = 0.1\text{ to }1.0\text{ GHz (STEP: }100\text{ MHz)}$

S_{21e}-FREQUENCY

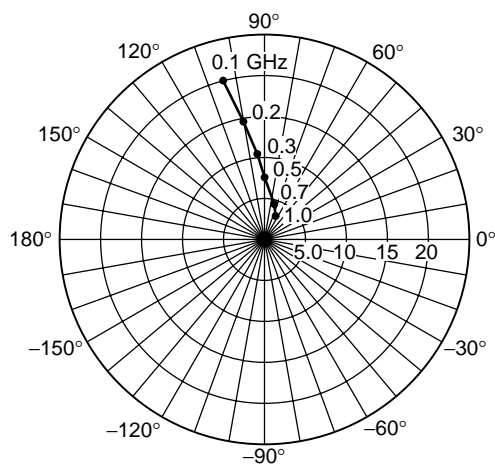

CONDITION $V_{CE} = 10\text{ V}$
 $I_C = 50\text{ mA}$

S_{12e}-FREQUENCY

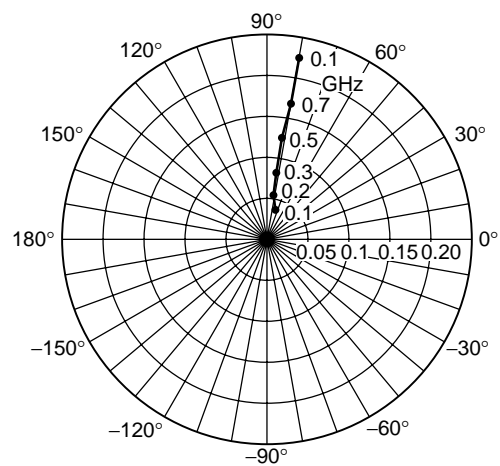

CONDITION $V_{CE} = 10\text{ V}$
 $I_C = 50\text{ mA}$

[MEMO]

[MEMO]

No part of this document may be copied or reproduced in any form or by any means without the prior written consent of NEC Corporation. NEC Corporation assumes no responsibility for any errors which may appear in this document.

NEC Corporation does not assume any liability for infringement of patents, copyrights or other intellectual property rights of third parties by or arising from use of a device described herein or any other liability arising from use of such device. No license, either express, implied or otherwise, is granted under any patents, copyrights or other intellectual property rights of NEC Corporation or others.

While NEC Corporation has been making continuous effort to enhance the reliability of its semiconductor devices, the possibility of defects cannot be eliminated entirely. To minimize risks of damage or injury to persons or property arising from a defect in an NEC semiconductor device, customers must incorporate sufficient safety measures in its design, such as redundancy, fire-containment, and anti-failure features.

NEC devices are classified into the following three quality grades:

"Standard", "Special", and "Specific". The Specific quality grade applies only to devices developed based on a customer designated "quality assurance program" for a specific application. The recommended applications of a device depend on its quality grade, as indicated below. Customers must check the quality grade of each device before using it in a particular application.

Standard: Computers, office equipment, communications equipment, test and measurement equipment, audio and visual equipment, home electronic appliances, machine tools, personal electronic equipment and industrial robots

Special: Transportation equipment (automobiles, trains, ships, etc.), traffic control systems, anti-disaster systems, anti-crime systems, safety equipment and medical equipment (not specifically designed for life support)

Specific: Aircrafts, aerospace equipment, submersible repeaters, nuclear reactor control systems, life support systems or medical equipment for life support, etc.

The quality grade of NEC devices is "Standard" unless otherwise specified in NEC's Data Sheets or Data Books. If customers intend to use NEC devices for applications other than those specified for Standard quality grade, they should contact an NEC sales representative in advance.

Anti-radioactive design is not implemented in this product.

This datasheet has been download from:

www.datasheetcatalog.com

Datasheets for electronics components.