

FRED Ultrafast Soft Recovery Diode, 2 x 15 A

FEATURES

- Ultrafast recovery
- Ultrasoft recovery
- Very low I_{RRM}
- Very low Q_{rr}
- Specified at operating conditions
- Designed and qualified for industrial level

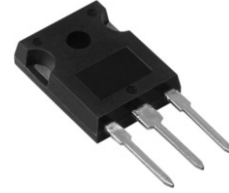

TO-247 AB

BENEFITS

- Reduced RFI and EMI
- Reduced power loss in diode and switching transistor
- Higher frequency operation
- Reduced snubbing
- Reduced parts count

DESCRIPTION

HFA30PA60C is a state of the art center tap ultrafast recovery diode. Employing the latest in epitaxial construction and advanced processing techniques it features a superb combination of characteristics which result in performance which is unsurpassed by any rectifier previously available. With basic ratings of 600V and 15A per leg continuous current, the HFA30PA60C is especially well suited for use as the companion diode for IGBTs and MOSFETs. In addition to ultrafast recovery time, the FRED product line features extremely low values of peak recovery current (I_{RRM}) and does not exhibit any tendency to “snap-off” during the t_b portion of recovery. The FRED features combine to offer designers a rectifier with lower noise and significantly lower switching losses in both the diode and the switching transistor. These FRED advantages can help to significantly reduce snubbing, component count and heatsink sizes. The FRED HFA30PA60C is ideally suited for applications in power conversion systems (such as inverters), motor drives, and many other similar applications where high speed, high efficiency is needed.

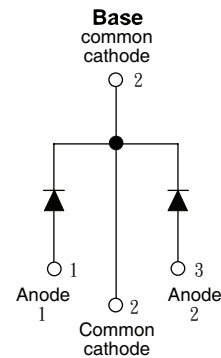

PRODUCT SUMMARY	
V_R	600 V
V_F at 15A at 25 °C	1.7 V
$I_{F(AV)}$	2 x 15 A
t_{rr} (typical)	19 ns
T_J (maximum)	150 °C
Q_{rr} (typical)	80 nC
$dI_{(rec)M}/dt$ (typical)	160 A/ μ s
I_{RRM} (typical)	4.0 A

ABSOLUTE MAXIMUM RATINGS

PARAMETER	SYMBOL	TEST CONDITIONS	VALUES	UNITS
Cathode to anode voltage	V_R		600	V
Maximum continuous forward current	I_F	$T_C = 100\text{ °C}$	15	A
			30	
Single pulse forward current	I_{FSM}		150	
Maximum repetitive forward current	I_{FRM}		60	
Maximum power dissipation	P_D	$T_C = 25\text{ °C}$	74	W
		$T_C = 100\text{ °C}$	29	
Operating junction and storage temperature range	T_J, T_{Stg}		- 55 to + 150	°C

Nell High Power Products

ELECTRICAL SPECIFICATIONS (T _J = 25 °C unless otherwise specified)						
PARAMETER	SYMBOL	TEST CONDITIONS	MIN.	TYP.	MAX.	UNITS
Cathode to anode breakdown voltage	V _{BR}	I _R = 100 μA	600	-	-	V
Maximum forward voltage	V _{FM}	I _F = 15 A	-	1.55	1.7	
		I _F = 30 A	-	1.80	2.0	
		I _F = 15 A, T _J = 125 °C	-	1.40	1.55	
Maximum reverse leakage current	I _{RM}	V _R = V _R rated	-	1.0	10	μA
		T _J = 125 °C, V _R = V _R rated	-	400	1000	
Junction capacitance	C _T	V _R = 200V	-	25	50	pF
Series inductance	L _S	Measured lead to lead 5 mm from package body	-	12	-	nH

DYNAMIC RECOVERY CHARACTERISTICS PERLEG (T _J = 25 °C unless otherwise specified)						
PARAMETER	SYMBOL	TEST CONDITIONS	MIN.	TYP.	MAX.	UNITS
Reverse recovery time	t _{rr}	I _F = 0.5A, I _R = 1.0A, I _{RR} = 250mA (RG#1 CKT)	-	25	33	ns
		I _F = 1.0 A, di _F /dt = -200 A/μs, V _R = 30 V, T _J = 25 °C	-	19	-	
	t _{rr1}	T _J = 25 °C	-	42	60	
	t _{rr2}	T _J = 125 °C	-	70	120	
Peak recovery current	I _{RRM1}	T _J = 25 °C	-	4.0	6.0	A
	I _{RRM2}	T _J = 125 °C	-	6.5	10	
Reverse recovery charge	Q _{rr1}	T _J = 25 °C	-	80	180	nC
	Q _{rr2}	T _J = 125 °C	-	220	600	
Peak rate of fall of recovery current during t _b	dl _{(rec)M} /dt1	T _J = 25 °C	-	250	-	A/μs
	dl _{(rec)M} /dt2	T _J = 125 °C	-	160	-	

THERMAL - MECHANICAL SPECIFICATIONS PER LEG						
PARAMETER	SYMBOL	TEST CONDITIONS	MIN.	TYP.	MAX.	UNITS
Lead temperature	T _{lead}	0.063" from case (1.6 mm) for 10 s	-	-	300	°C
Junction to case, single leg conduction	R _{thJC}		-	-	1.7	K/W
Junction to case, both legs conducting			-	-	0.85	
Thermal resistance, junction to ambient	R _{thJA}	Typical socket mount	-	-	40	
Thermal resistance, case to heatsink	R _{thCS}	Mounting surface, flat, smooth and greased	-	0.25	-	
Weight			-	6.0	-	g
			-	0.21	-	oz.
Mounting torque			6.0 (5.0)	-	12 (10)	kgf . cm (lbf . in)
Marking device		Case style TO-247AB (JEDEC)	HFA30PA60C			

Fig.1 Maximum Forward Voltage Drop vs. Instantaneous Forward Current (Per Leg)

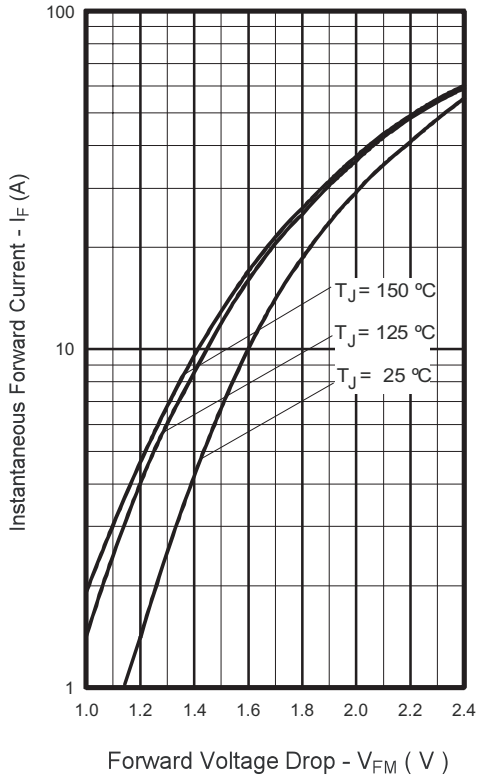

Fig.2 Typical Reverse Current vs. Reverse Voltage (Per Leg)

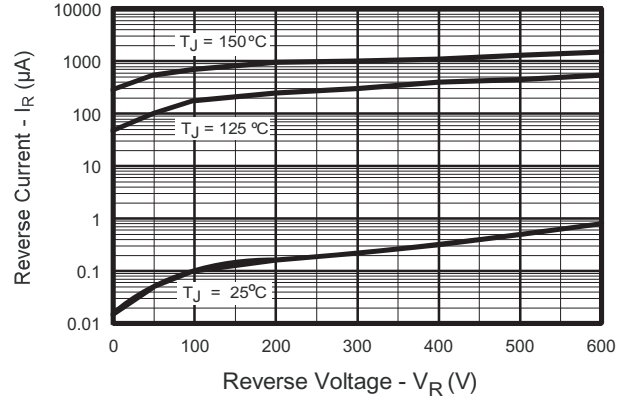

Fig.3 Typical Junction Capacitance vs. Reverse Voltage (Per Leg)

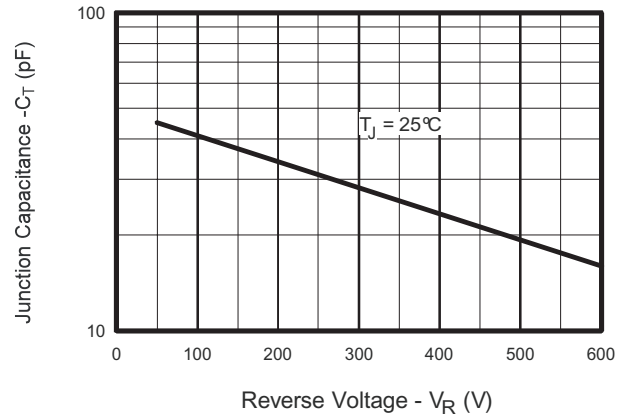

Fig.4 Maximum Thermal Impedance Z_{thJC} Characteristics (Per Leg)

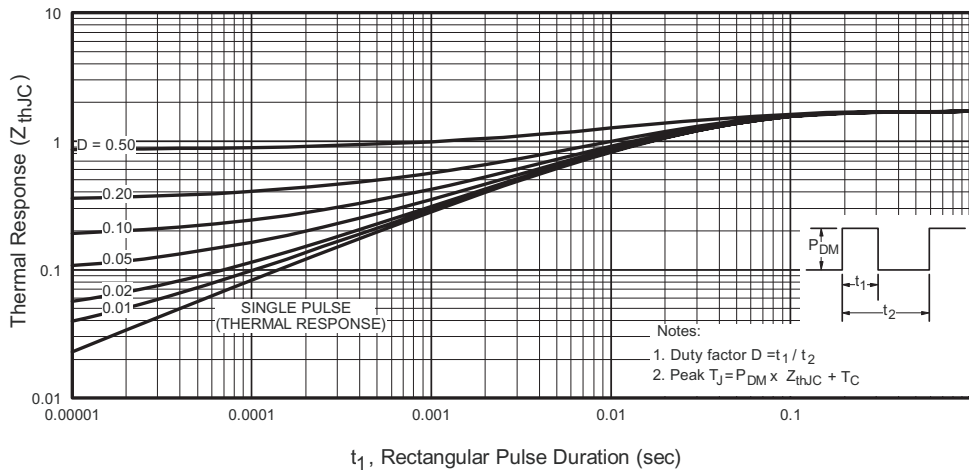

Fig.5 Typical Reverse Recovery Time vs. di_F/dt (Per Leg)

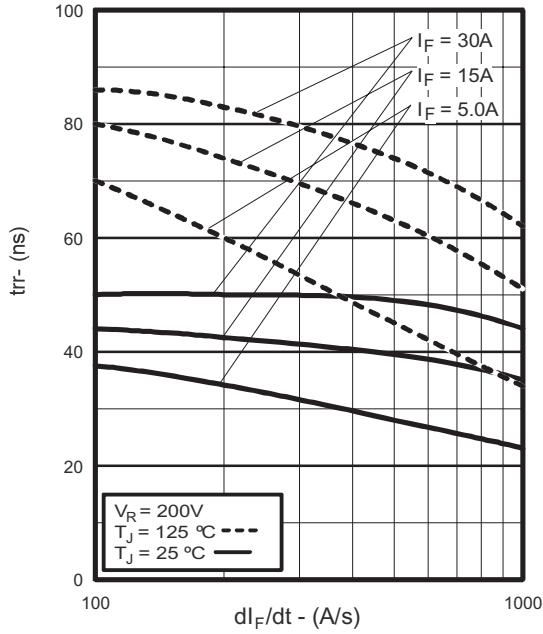

Fig.7 Typical Stored Charge vs. di_F/dt (Per Leg)

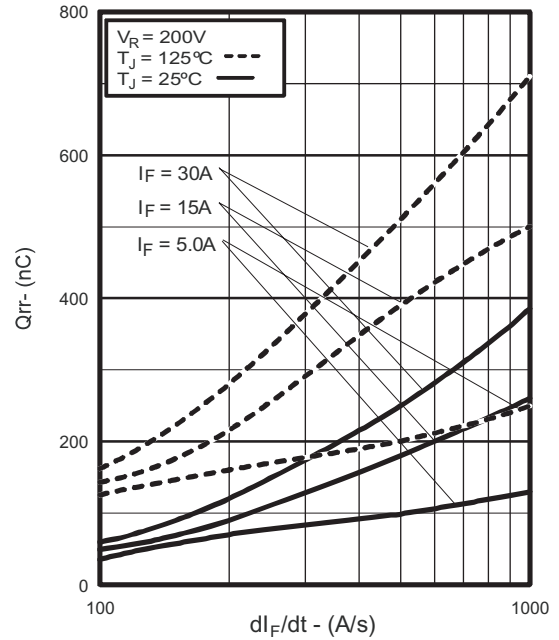

Fig.6 Typical Recovery Current vs. di_F/dt (Per Leg)

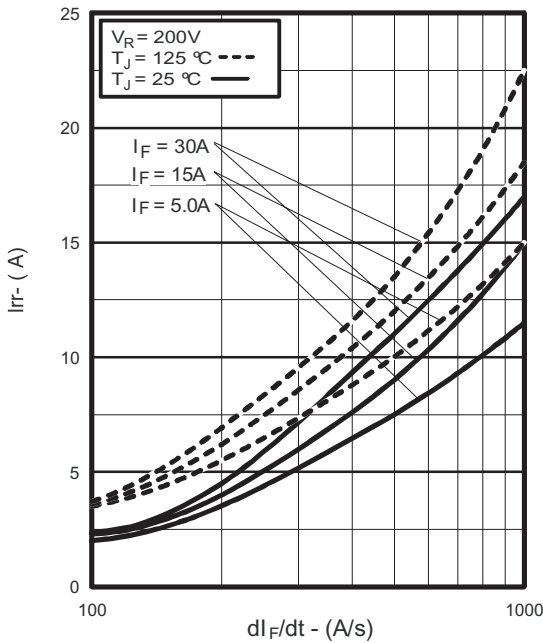

Fig.8 Typical $dI_{(rec)M}/dt$ vs. di_F/dt (Per Leg)

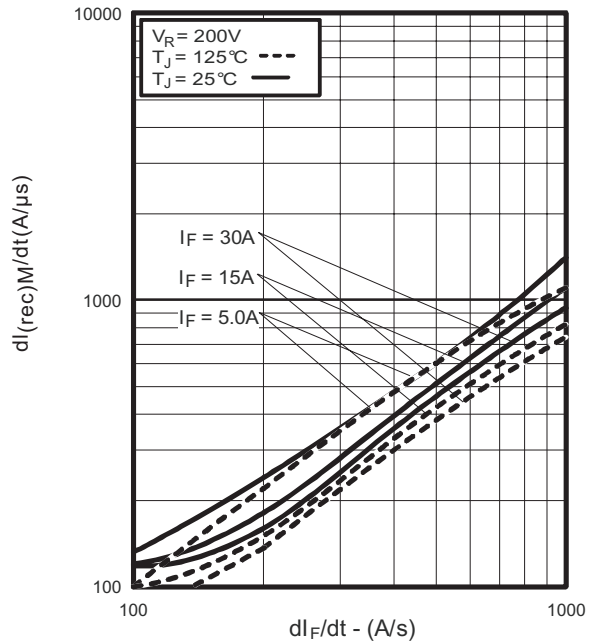

Fig.9 Reverse Recovery Parameter Test Circuit

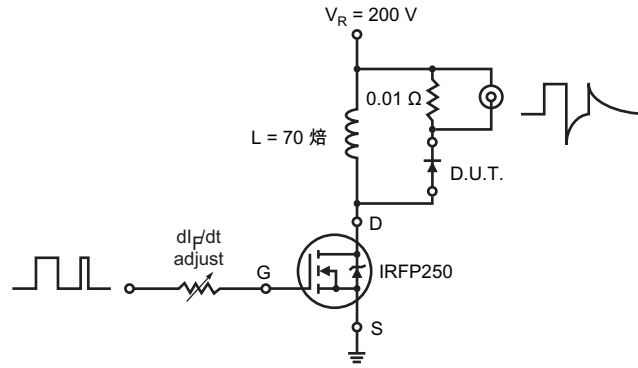
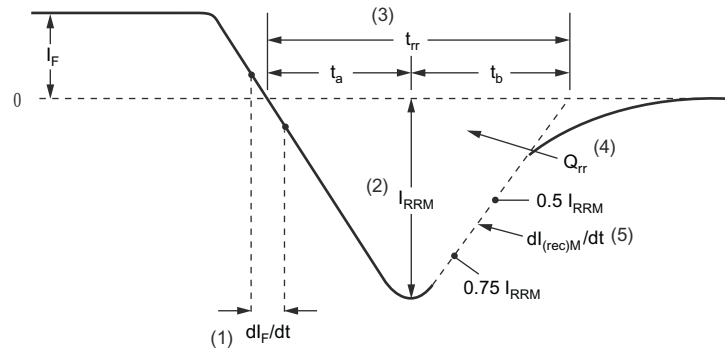

Fig.10 Reverse Recovery Waveform and Definitions



(1) di_F/dt - rate of change of current through zero crossing

(2) I_{RRM} - peak reverse recovery current

(3) t_{rr} - reverse recovery time measured from zero crossing point of negative going I_F to point where a line passing through $0.75 I_{RRM}$ and $0.50 I_{RRM}$ extrapolated to zero current.

(4) Q_{rr} - area under curve defined by t_{rr} and I_{RRM}

$$Q_{rr} = \frac{t_{rr} \times I_{RRM}}{2}$$

(5) $di_{(rec)M}/dt$ - peak rate of change of current during t_b portion of t_{rr}

ORDERING INFORMATION TABLE

Device code	N	-	HFA	30	PA	60	C
	①		②	③	④	⑤	⑥

- 1** - Nell Semiconductors product
- 2** - FRED family
- 3** - Current rating (30 = 30 A, 15A x 2)
- 4** - Package outline (PA = TO-247, 3 pins)
- 5** - Voltage rating (60 = 600 V)
- 6** - Configuration (C = Center tap common cathode)

