

## Schottky Rectifier, 2 x 40 A

**TO-247AC**

### FEATURES

- 150 °C  $T_J$  operation
- Optimized for 3.3 V application
- Ultralow forward voltage drop
- High frequency operation
- Guard ring for enhanced ruggedness and long term reliability
- High purity, high temperature epoxy encapsulation for enhanced mechanical strength and moisture resistance
- Compliant to RoHS Directive 2002/95/EC
- Designed and qualified according to JEDEC-JESD47
- Halogen-free according to IEC 61249-2-21 definition (-N3 only)

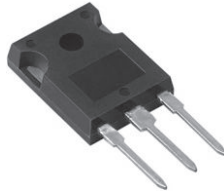
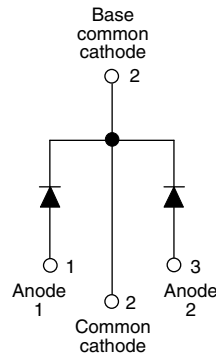

### DESCRIPTION

This center tap Schottky rectifier has been optimized for ultralow forward voltage drop specifically for 3.3 V output power supplies. The proprietary barrier technology allows for reliable operation up to 150 °C junction temperature. Typical applications are in parallel switching power supplies, converters, reverse battery protection, and redundant power subsystems.

PRODUCT SUMMARY	
Package	TO-247AC
$I_{F(AV)}$	2 x 40 A
$V_R$	20 V
$V_F$ at $I_F$	0.36 V
$I_{RM}$ max.	1100 mA at 125 °C
$T_J$ max.	150 °C
Diode variation	Common cathode
$E_{AS}$	27 mJ

MAJOR RATINGS AND CHARACTERISTICS			
SYMBOL	CHARACTERISTICS	VALUES	UNITS
$I_{F(AV)}$	Rectangular waveform	80	A
$V_{RRM}$		20	V
$I_{FSM}$	$t_p = 5 \mu s$ sine	2200	A
$V_F$	40 Apk, $T_J = 150$ °C (per leg)	0.32	V
$T_J$	Range	- 55 to 150	°C

VOLTAGE RATINGS				
PARAMETER	SYMBOL	VS-80CPQ020PbF	VS-80CPQ020-N3	UNITS
Maximum DC reverse voltage	$V_R$	20	20	V
Maximum working peak reverse voltage	$V_{RWM}$			

ABSOLUTE MAXIMUM RATINGS					
PARAMETER	SYMBOL	TEST CONDITIONS		VALUES	UNITS
Maximum average forward current per leg per device	$I_{F(AV)}$	50 % duty cycle at $T_C = 138$ °C, rectangular waveform		40	A
				80	
Maximum peak one cycle non-repetitive surge current per leg	$I_{FSM}$	5 $\mu s$ sine or 3 $\mu s$ rect. pulse	Following any rated load condition and with rated $V_{RRM}$ applied	2200	
		10 ms sine or 6 ms rect. pulse		500	
Non-repetitive avalanche energy per leg	$E_{AS}$	$T_J = 25$ °C, $I_{AS} = 6$ A, $L = 1.5$ mH		27	mJ
Repetitive avalanche current per leg	$I_{AR}$	Current decaying linearly to zero in 1 $\mu s$ Frequency limited by $T_J$ maximum $V_A = 1.5 \times V_R$ typical		6	A



ELECTRICAL SPECIFICATIONS							
PARAMETER	SYMBOL	TEST CONDITIONS		VALUES	UNITS		
Maximum forward voltage drop per leg	$V_{FM}^{(1)}$	40 A	$T_J = 25\text{ }^\circ\text{C}$	0.46	V		
		80 A		0.55			
		40 A	$T_J = 125\text{ }^\circ\text{C}$	0.36		V	
		80 A		0.46			
		40 A	$T_J = 150\text{ }^\circ\text{C}$	0.32			V
		80 A		0.43			
Maximum reverse leakage current per leg	$I_{RM}^{(1)}$	$T_J = 125\text{ }^\circ\text{C}$	$V_R = 5\text{ V}$	110	mA		
		$T_J = 150\text{ }^\circ\text{C}$	$V_R = 10\text{ V}$	600			
		$T_J = 25\text{ }^\circ\text{C}$	$V_R = \text{Rated } V_R$	5.5			
		$T_J = 125\text{ }^\circ\text{C}$		1100			
Threshold voltage	$V_{F(TO)}$	$T_J = T_J \text{ maximum}$		0.185	V		
Maximum junction capacitance per leg	$C_T$	$V_R = 5\text{ V}_{DC}$ (test signal range 100 kHz to 1 MHz) $25\text{ }^\circ\text{C}$		6500	pF		
Typical series inductance per leg	$L_S$	Measured lead to lead 5 mm from package body		7.5	nH		
Maximum voltage rate of change	dV/dt	Rated $V_R$		10 000	V/ $\mu\text{s}$		

**Note**(1) Pulse width < 300  $\mu\text{s}$ , duty cycle < 2 %

THERMAL - MECHANICAL SPECIFICATIONS					
PARAMETER	SYMBOL	TEST CONDITIONS		VALUES	UNITS
Maximum junction and storage temperature range	$T_J, T_{Stg}$			- 55 to 150	$^\circ\text{C}$
Maximum thermal resistance, junction to case per leg	$R_{thJC}$	DC operation		0.6	$^\circ\text{C/W}$
Maximum thermal resistance, junction to case per package				0.3	
Typical thermal resistance, case to heatsink	$R_{thCS}$	Mounting surface, smooth and greased		0.25	
Approximate weight				6	g
				0.21	oz.
Mounting torque	minimum maximum			6 (5)	kgf · cm (lbf · in)
				12 (10)	
Marking device		Case style TO-247AC (JEDEC)		80CPQ020	

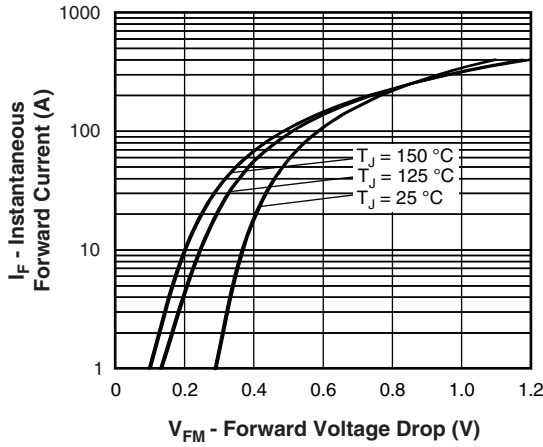

Fig. 1 - Maximum Forward Voltage Drop Characteristics (Per Leg)

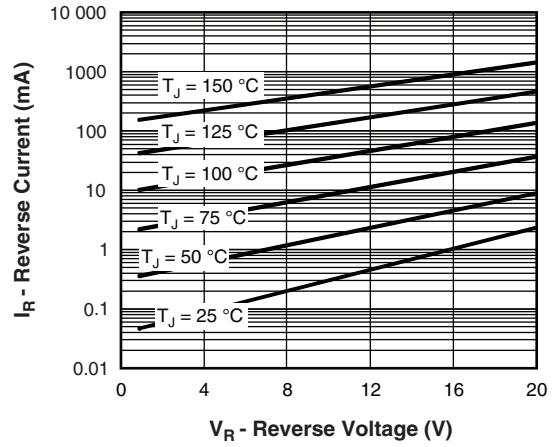

Fig. 2 - Typical Values of Reverse Current vs. Reverse Voltage (Per Leg)

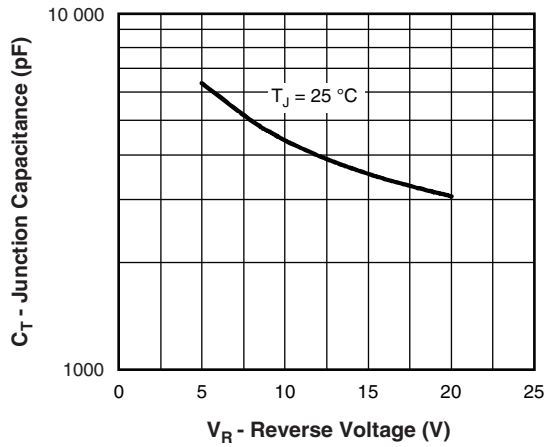

Fig. 3 - Typical Junction Capacitance vs. Reverse Voltage (Per Leg)

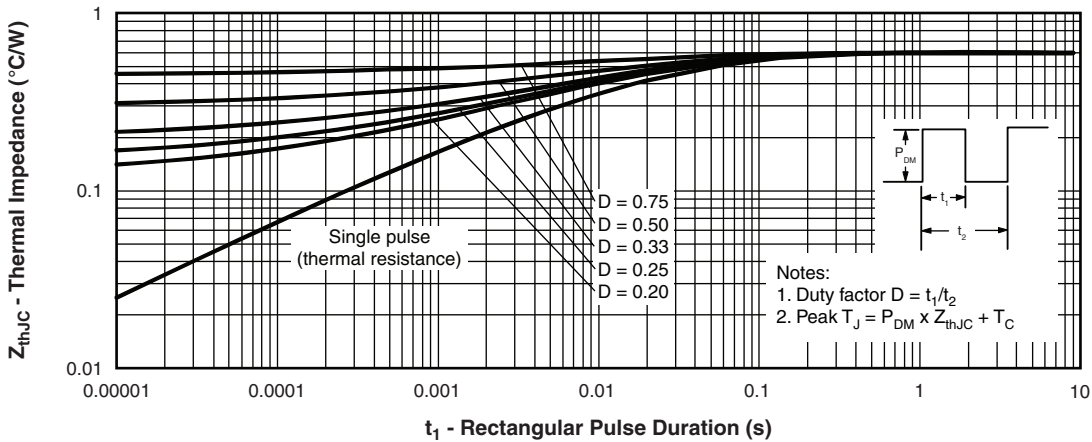

Fig. 4 - Maximum Thermal Impedance  $Z_{thJC}$  Characteristics (Per Leg)

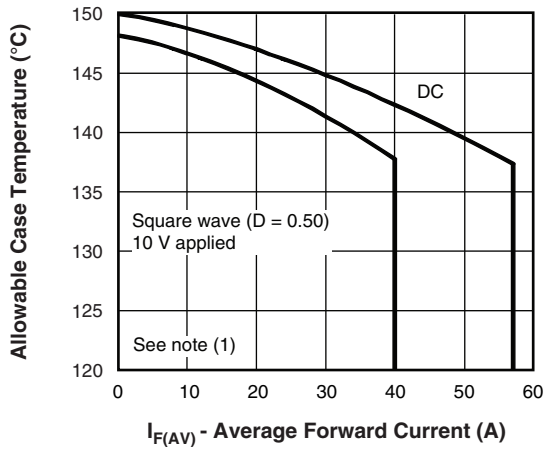

Fig. 5 - Maximum Allowable Case Temperature vs. Average Forward Current (Per Leg)

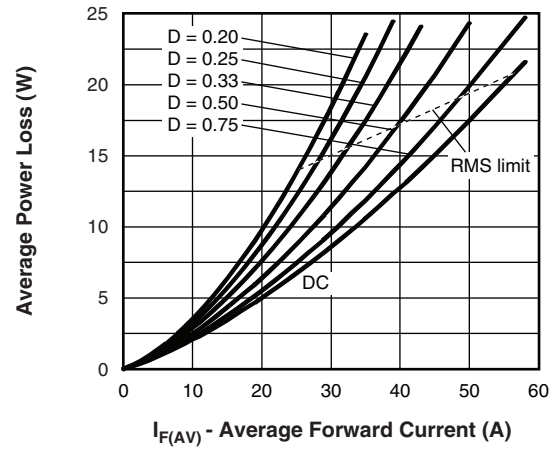

Fig. 6 - Forward Power Loss Characteristics (Per Leg)

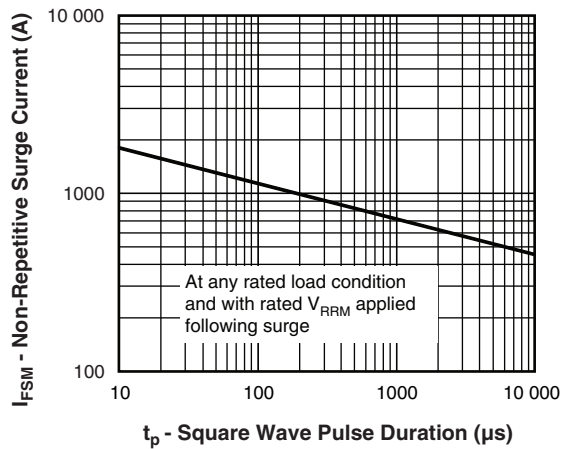

Fig. 7 - Maximum Non-Repetitive Surge Current (Per Leg)

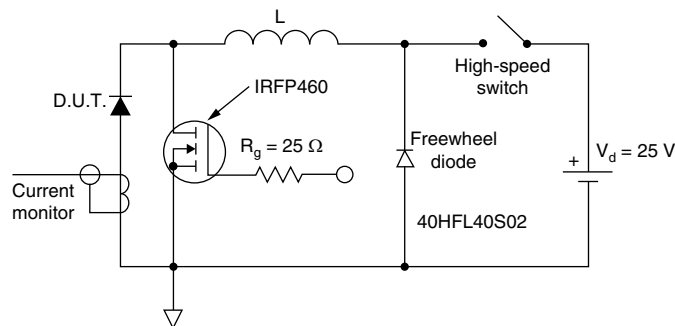

Fig. 8 - Unclamped Inductive Test Circuit

**Note**

- (1) Formula used:  $T_C = T_J - (P_d + P_{dREV}) \times R_{thJC}$ ;
- $P_d$  = Forward power loss =  $I_{F(AV)} \times V_{FM}$  at  $(I_{F(AV)}/D)$  (see fig. 6);
- $P_{dREV}$  = Inverse power loss =  $V_{R1} \times I_R (1 - D)$ ;  $I_R$  at  $V_{R1} = 10 V$



## ORDERING INFORMATION TABLE

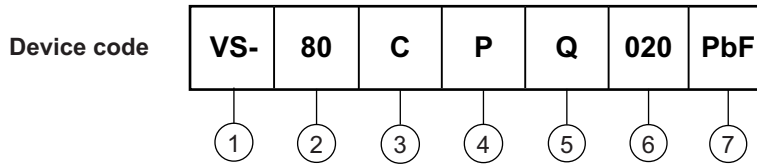

- 1** - Vishay Semiconductors product
- 2** - Current rating (80 = 80 A)
- 3** - Circuit configuration:  
C = Common cathode
- 4** - Package:  
P = TO-247
- 5** - Schottky "Q" series
- 6** - Voltage code (020 = 20 V)
- 7** - Environmental digit
  - PbF = Lead (Pb)-free and RoHS compliant
  - -N3 = Halogen-free, RoHS compliant, and totally lead (Pb)-free

ORDERING INFORMATION (Example)			
PREFERRED P/N	QUANTITY PER T/R	MINIMUM ORDER QUANTITY	PACKAGING DESCRIPTION
VS-80CPQ020PbF	25	500	Antistatic plastic tube
VS-80CPQ020-N3	25	500	Antistatic plastic tube

LINKS TO RELATED DOCUMENTS	
Dimensions	<a href="http://www.vishay.com/doc?95223">www.vishay.com/doc?95223</a>
Part marking information	TO-247AC PbF <a href="http://www.vishay.com/doc?95226">www.vishay.com/doc?95226</a>
	TO-247AC -N3 <a href="http://www.vishay.com/doc?95007">www.vishay.com/doc?95007</a>
SPIICE model	<a href="http://www.vishay.com/doc?95289">www.vishay.com/doc?95289</a>



## TO-247AC

**DIMENSIONS** in millimeters and inches

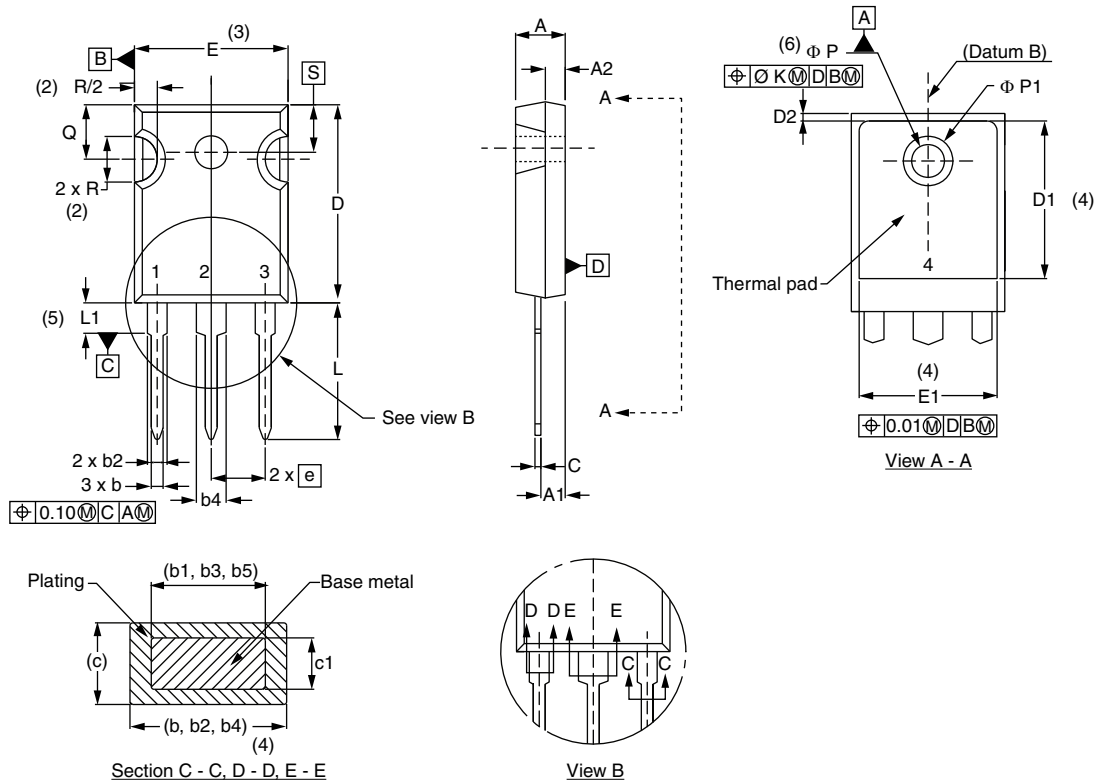

SYMBOL	MILLIMETERS		INCHES		NOTES	SYMBOL	MILLIMETERS		INCHES		NOTES
	MIN.	MAX.	MIN.	MAX.			MIN.	MAX.	MIN.	MAX.	
A	4.65	5.31	0.183	0.209		D2	0.51	1.30	0.020	0.051	
A1	2.21	2.59	0.087	0.102		E	15.29	15.87	0.602	0.625	3
A2	1.50	2.49	0.059	0.098		E1	13.72	-	0.540	-	
b	0.99	1.40	0.039	0.055		e	5.46 BSC		0.215 BSC		
b1	0.99	1.35	0.039	0.053		$\emptyset$ K	2.54		0.010		
b2	1.65	2.39	0.065	0.094		L	14.20	16.10	0.559	0.634	
b3	1.65	2.34	0.065	0.092		L1	3.71	4.29	0.146	0.169	
b4	2.59	3.43	0.102	0.135		$\emptyset$ P	3.56	3.66	0.14	0.144	
b5	2.59	3.38	0.102	0.133		$\emptyset$ P1	-	6.98	-	0.275	
c	0.38	0.89	0.015	0.035		Q	5.31	5.69	0.209	0.224	
c1	0.38	0.84	0.015	0.033		R	4.52	5.49	0.178	0.216	
D	19.71	20.70	0.776	0.815	3	S	5.51 BSC		0.217 BSC		
D1	13.08	-	0.515	-	4						

**Notes**

- (1) Dimensioning and tolerancing per ASME Y14.5M-1994
- (2) Contour of slot optional
- (3) Dimension D and E do not include mold flash. Mold flash shall not exceed 0.127 mm (0.005") per side. These dimensions are measured at the outermost extremes of the plastic body
- (4) Thermal pad contour optional with dimensions D1 and E1
- (5) Lead finish uncontrolled in L1
- (6)  $\emptyset$  P to have a maximum draft angle of 1.5 to the top of the part with a maximum hole diameter of 3.91 mm (0.154")
- (7) Outline conforms to JEDEC® outline TO-247 with exception of dimension c



## **Disclaimer**

ALL PRODUCT, PRODUCT SPECIFICATIONS AND DATA ARE SUBJECT TO CHANGE WITHOUT NOTICE TO IMPROVE RELIABILITY, FUNCTION OR DESIGN OR OTHERWISE.

Vishay Intertechnology, Inc., its affiliates, agents, and employees, and all persons acting on its or their behalf (collectively, "Vishay"), disclaim any and all liability for any errors, inaccuracies or incompleteness contained in any datasheet or in any other disclosure relating to any product.

Vishay makes no warranty, representation or guarantee regarding the suitability of the products for any particular purpose or the continuing production of any product. To the maximum extent permitted by applicable law, Vishay disclaims (i) any and all liability arising out of the application or use of any product, (ii) any and all liability, including without limitation special, consequential or incidental damages, and (iii) any and all implied warranties, including warranties of fitness for particular purpose, non-infringement and merchantability.

Statements regarding the suitability of products for certain types of applications are based on Vishay's knowledge of typical requirements that are often placed on Vishay products in generic applications. Such statements are not binding statements about the suitability of products for a particular application. It is the customer's responsibility to validate that a particular product with the properties described in the product specification is suitable for use in a particular application. Parameters provided in datasheets and / or specifications may vary in different applications and performance may vary over time. All operating parameters, including typical parameters, must be validated for each customer application by the customer's technical experts. Product specifications do not expand or otherwise modify Vishay's terms and conditions of purchase, including but not limited to the warranty expressed therein.

Except as expressly indicated in writing, Vishay products are not designed for use in medical, life-saving, or life-sustaining applications or for any other application in which the failure of the Vishay product could result in personal injury or death. Customers using or selling Vishay products not expressly indicated for use in such applications do so at their own risk. Please contact authorized Vishay personnel to obtain written terms and conditions regarding products designed for such applications.

No license, express or implied, by estoppel or otherwise, to any intellectual property rights is granted by this document or by any conduct of Vishay. Product names and markings noted herein may be trademarks of their respective owners.