

AN48800A

Low current consumption, high sensitivity CMOS Hall IC One-way magnetic field operation

Overview

The AN48800A is a Hall IC (a magnetic sensor) which has 2 times or more sensitivity and a low current consumption of about one three-hundredth compared with our conventional one.

In this Hall IC, a Hall element, an offset cancel circuit, an amplifier circuit, a sample and hold circuit, a Schmidt circuit, and output stage FET are integrated on a single chip housed in a small package by IC technique.

Features

- High sensitivity (6 mT max.) due to offset cancel circuit and a new sample and hold circuit
- Small current by using intermittent action
- Small package (SMD)
- Open drain output

Applications

- Flip type cellular phone, digital video camera

Block Diagram

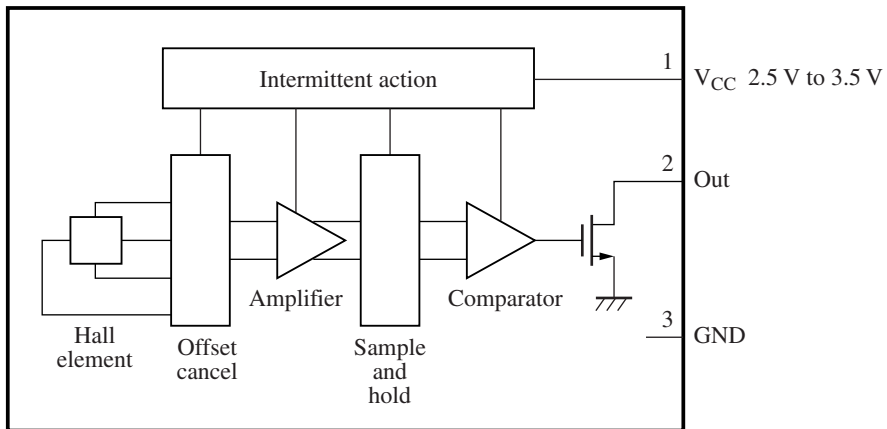

Note) The magnetism detection time should be longer than one intermittent action cycle (On = 200 μ s and Off = 51 ms).

Pin Descriptions

Pin No.	Symbol	Description
1	V _{CC}	Power supply
2	Out	Output
3	GND	Ground

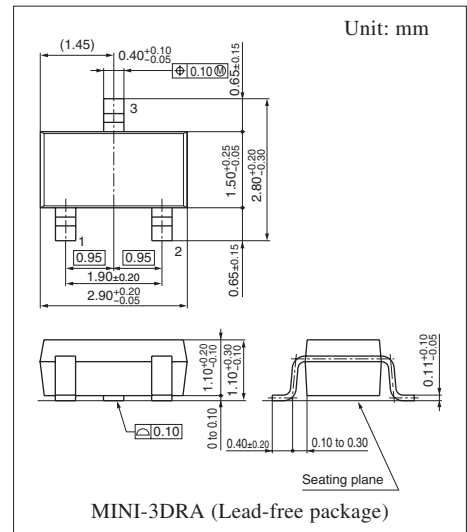

■ Absolute Maximum Ratings

Parameter	Symbol	Rating	Unit
Supply voltage	V_{CC}	5	V
	V_{OUT}	5	V
Output current	I_O	30	mA
Power dissipation	P_D	60	mW
Operating ambient temperature	T_{opr}	-20 to +75	°C
Storage temperature	T_{stg}	-55 to +125	°C

Note) 1. Except for the operating ambient temperature and storage temperature, all ratings are for $T_a = 25^\circ\text{C}$.

2. The reverse insertion of this IC will cause its breakdown.
3. It will operate normally in several tens of ms after power on.
4. This IC is not suitable for car electrical equipment.

■ Recommended Operating Range

Parameter	Symbol	Range	Unit
Supply voltage	V_{CC}	2.5 to 3.5	V

■ Electrical Characteristics at $T_a = 25^\circ\text{C}$

Parameter	Symbol	Conditions	Min	Typ	Max	Unit
Operating magnetic flux density 1	B_{H-L}	$V_{CC} = 3\text{ V}$	—	—	6	mT
Operating magnetic flux density 2	B_{L-H}	$V_{CC} = 3\text{ V}$	0.5	—	—	mT
Hysteresis width	BW	$V_{CC} = 3\text{ V}$	—	1.2	—	mT
Output voltage	V_{OL}	$V_{CC} = 3\text{ V}$, $I_O = 5\text{ mA}$, $B = 6\text{ mT}$	—	0.1	0.3	V
Output current	I_{OH}	$V_{CC} = 3\text{ V}$, $V_O = 3\text{ V}$, $B = 0.5\text{ mT}$	—	—	10	μA
Supply current 1	I_{CCON}	$V_{CC} = 3\text{ V}$, $B = 0.5\text{ mT}$	—	2	—	mA
Supply current 2	I_{CCOFF}	$V_{CC} = 3\text{ V}$, $B = 0.5\text{ mT}$	—	3	—	μA
Supply current 3	I_{CCAVE}	$V_{CC} = 3\text{ V}$, $B = 0.5\text{ mT}$	—	10	15	μA

Note) 1. Symbol B_{H-L} stands for the operating magnetic flux density where its output level varies from high to low.

2. Symbol B_{L-H} stands for the operating magnetic flux density where its output level varies from low to high.

3. I_{CCON} is a consumption current when the magnetism detection system is on, and I_{CCOFF} is that when the magnetism detection system is off. One magnetism detection cycle is On = 200 μs and Off = 51 ms. I_{CCAVE} is an average consumption current.

■ Technical Data

• Position of a Hall element (unit in mm)

Distance from a package surface to sensor part: 0.39 mm (reference value)

A Hall element is placed on the shaded part in the figure.

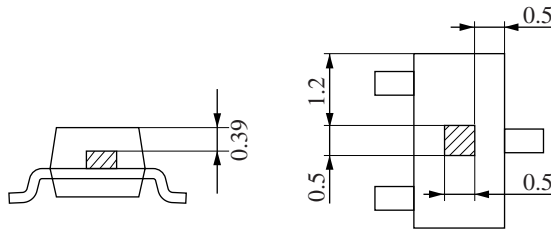

• Magneto-electro conversion characteristics

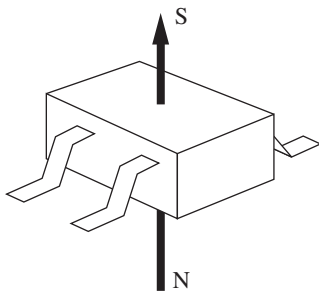

Direction of applied magnetic field

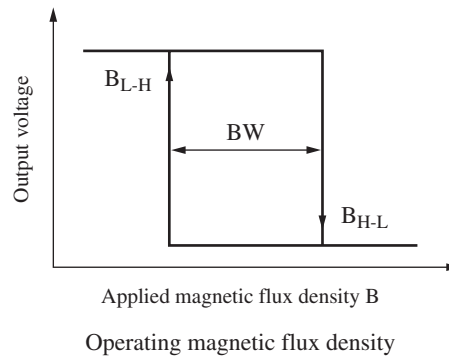

• Simple polarity distinction method of mounting magnet to product incorporating Hall IC

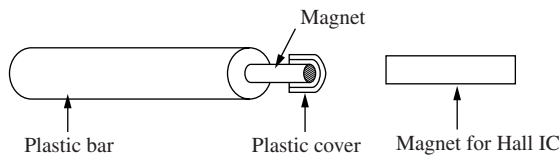

A magnet, which is used in pair with a Hall IC, can be mounted to a product incorporating a built-in Hall IC (e.g., a cellular phone) smoothly and correctly with a simple tool. The polarity of the magnet (hereafter referred to as Hall IC magnet) will be automatically discriminated.

This tool is a plastic bar, one end of which is attached with a small magnet (hereafter referred to as plastic bar magnet), as shown in the above illustration. The plastic bar magnet, the polarity of which is known, is secured on the bar with a plastic cover. When the plastic bar magnet is located close to the Hall IC magnet, the Hall IC magnet will be attracted to the plastic bar magnet. The contact side of the Hall IC magnet is different in polarity from that of the plastic bar magnet. As a matter of course, the polarity of the Hall IC magnet will be known then. The Hall IC magnet can be mounted to the appliance in this state. The attraction force of the plastic bar magnet is rather weak due to the plastic cover on it. Therefore, the plastic bar can be separated from the Hall IC magnet with ease after the Hall IC magnet is mounted properly.

■ Technical Data (continued)

• Main characteristics

Operating magnetic flux density — Supply voltage

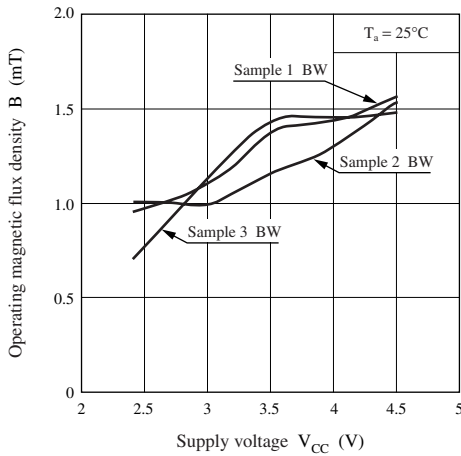

Operating magnetic flux density — Ambient temperature

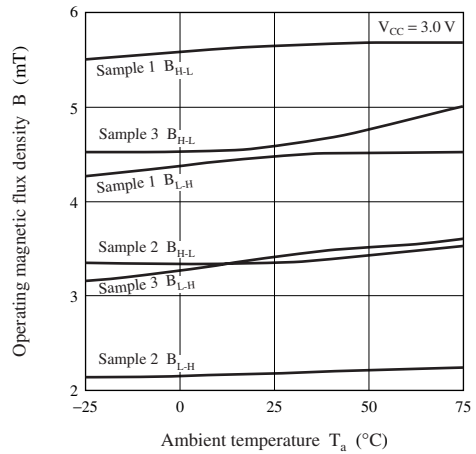

Operating magnetic flux density — Supply voltage

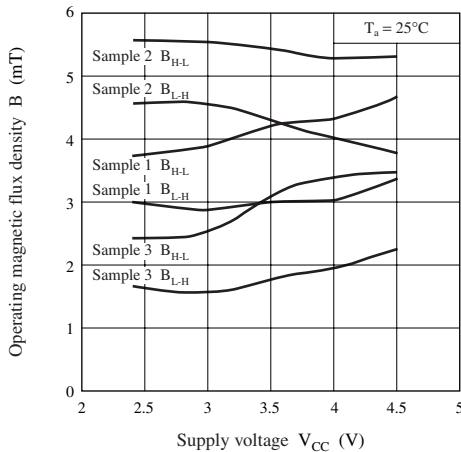

Average consumption current — Supply voltage

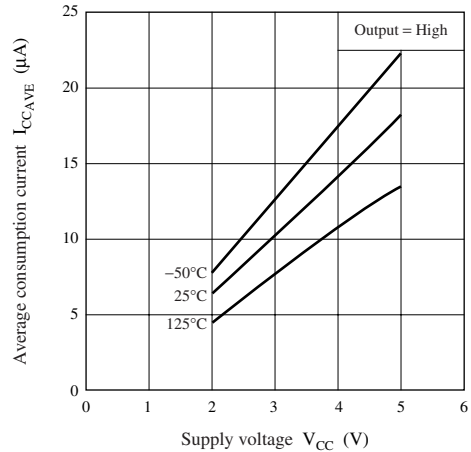

Low-level output voltage — Supply voltage

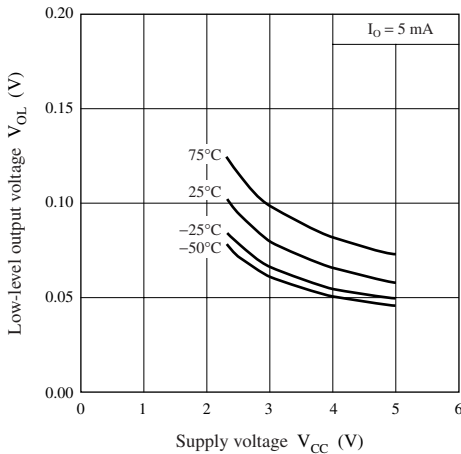

Low-level output voltage — Ambient temperature

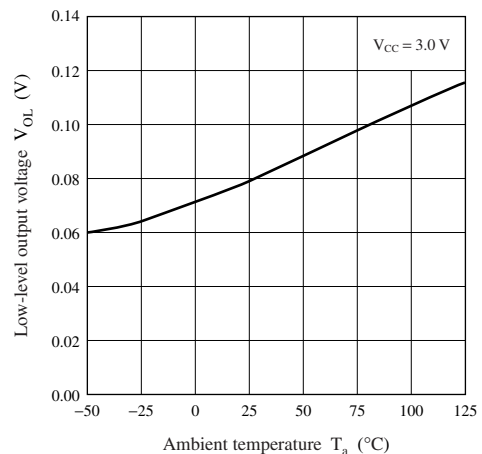

■ Caution on Use of Hall ICs

The Hall ICs are often used to detect movement. In such cases, the position of the Hall IC may be changed by exposition to shock or vibration over a long period of time, and it causes the detection level change. To prevent this, fix the package with adhesives or fix it on a dedicated case.

1. A case using an adhesive

Some kinds of adhesive generate corrosive gas (such as chloric gas) during curing. This corrosive gas corrodes the aluminum on the surface of the Hall IC, and may cause a functional defect of disconnection.

If Hall IC is to be sealed after installation, attention should be given to the adhesive or resin used for peripherals and substrate cleaner, as well as to the adhesive used for Hall IC installation. Please confirm the above matter to those manufacturers before using.

We could not select the specified adhesive, for we find it difficult to guarantee the ingredient of each adhesive.

2. Power supply line/Power transmission line

If a power supply line/power transmission line becomes longer, noise and/or oscillation may be found on the line. In this case, set the capacitor of 0.1 μF to 10 μF near the Hall IC to prevent it.

If a voltage of 18 V or more is thought to be applied to the power supply line (flyback voltage from coil or the ignition pulse, etc.), avoid it with external components (capacitor, resistor, Zener diode, diode, surge absorbing elements, etc.).

3. On mounting of the surface mount type package (MINI-3DR)

When mounted on the printed circuit board, the Hall IC may be highly stressed by the warp that may occur from the soldering. This may also cause a change in the operating magnetic flux density and a deterioration of its resistance to moisture.



4. V_{CC} and GND

Do not reverse V_{CC} and GND. If the V_{CC} and GND pins are reversely connected, this IC will be destroyed. If the IC GND-pin voltage is set higher than other pin voltage, the IC configuration will become the same as a forward biased diode. Therefore, it will turn on at the diode forward voltage (approximately 0.7 V), and a large current will flow through the IC, ending up in its destruction. (This is common to monolithic IC.)

5. Cautions on power-on of Hall IC

When a Hall IC is turned on, the position of the magnet or looseness may change the output of a Hall IC, and a pulse may be generated. Therefore, care should be given whenever the output state of a Hall IC is critical when the supply power is on.

6. On fixing a Hall IC to holder

When a Hall IC is mounted on the printed circuit board with a holder and the coefficient of expansion of the holder is large, the lead wire of the Hall IC will be stretched and it may give a stress to the Hall IC.

If the lead wire is stressed intensely due to the distortion of holder or board, the adhesives between the package and the lead wire may be weakened and cause a minute gap resulting in the deterioration of its resistance to moisture.

Sensitivity may also be changed by this stress.

7. On using flux in soldering

Choose a flux which does not include ingredients from halogen group, such as chlorine, fluorine, etc. The ingredients of halogen group may enter where the lead frame and package resin joint, causing corrosion and the disconnection of the aluminum wiring on the surface of an IC chip.

8. In case of the magnetic field of a magnet is too strong

Output may be inverted when applying a magnetic flux density of 100 mT or more. Accordingly, magnetic flux density should be used within the range of 100 mT.

9. On surface treatment of mini-mold package

Surface treatment is available in either smooth or dull finish.

10. On soldering of the surface mount type package

Surface mounting type Hall ICs are apt to change its electrical characteristics due to the stress from soldering at mounting. Therefore, avoid the mounting by flow (dipping) and a soldering iron. Please mount it by reflow soldering abiding by its recommended conditions.

Request for your special attention and precautions in using the technical information and semiconductors described in this material

- (1) An export permit needs to be obtained from the competent authorities of the Japanese Government if any of the products or technologies described in this material and controlled under the "Foreign Exchange and Foreign Trade Law" is to be exported or taken out of Japan.
- (2) The technical information described in this material is limited to showing representative characteristics and applied circuits examples of the products. It neither warrants non-infringement of intellectual property right or any other rights owned by our company or a third party, nor grants any license.
- (3) We are not liable for the infringement of rights owned by a third party arising out of the use of the product or technologies as described in this material.
- (4) The products described in this material are intended to be used for standard applications or general electronic equipment (such as office equipment, communications equipment, measuring instruments and household appliances).
Consult our sales staff in advance for information on the following applications:
 - Special applications (such as for airplanes, aerospace, automobiles, traffic control equipment, combustion equipment, life support systems and safety devices) in which exceptional quality and reliability are required, or if the failure or malfunction of the products may directly jeopardize life or harm the human body.
 - Any applications other than the standard applications intended.
- (5) The products and product specifications described in this material are subject to change without notice for modification and/or improvement. At the final stage of your design, purchasing, or use of the products, therefore, ask for the most up-to-date Product Standards in advance to make sure that the latest specifications satisfy your requirements.
- (6) When designing your equipment, comply with the guaranteed values, in particular those of maximum rating, the range of operating power supply voltage, and heat radiation characteristics. Otherwise, we will not be liable for any defect which may arise later in your equipment.
Even when the products are used within the guaranteed values, take into the consideration of incidence of break down and failure mode, possible to occur to semiconductor products. Measures on the systems such as redundant design, arresting the spread of fire or preventing glitch are recommended in order to prevent physical injury, fire, social damages, for example, by using the products.
- (7) When using products for which damp-proof packing is required, observe the conditions (including shelf life and amount of time let standing of unsealed items) agreed upon when specification sheets are individually exchanged.
- (8) This material may be not reprinted or reproduced whether wholly or partially, without the prior written permission of Matsushita Electric Industrial Co., Ltd.

This datasheet has been download from:

www.datasheetcatalog.com

Datasheets for electronics components.