

General Description

OST15N65KRF uses advanced Oriental-Semi's patented Trident-Gate Bipolar Transistor (TGBT™) technology to provide extremely low $V_{CE(sat)}$, low gate charge, and excellent switching performance. This device is suitable for mid to high range switching frequency converters.

Features

- Advanced TGBT™ technology
- Excellent conduction and switching loss
- Excellent stability and uniformity
- Fast and soft antiparallel diode



Applications

- Induction converters
- Uninterruptible power supplies

Key Performance Parameters

Parameter	Value	Unit
$V_{CES, min} @ 25\text{ °C}$	650	V
Maximum junction temperature	175	°C
$I_C, pulse$	45	A
$V_{CE(sat), typ} @ V_{GE}=15\text{ V}$	1.65	V
Q_g	73	nC

Marking Information

Product Name	Package	Marking
OST15N65KRF	TO263	OST15N65KR

Package & Pin Information

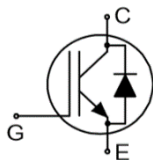

Absolute Maximum Ratings at $T_{vj}=25\text{ °C}$ unless otherwise noted

Parameter	Symbol	Value	Unit
Collector emitter voltage	V_{CES}	650	V
Gate emitter voltage	V_{GES}	± 20	V
Transient gate emitter voltage, $T_P \leq 10\ \mu s$, $D < 0.01$		± 30	V
Continuous collector current ¹⁾ , $T_C = 25\text{ °C}$	I_C	30	A
Continuous collector current ¹⁾ , $T_C = 100\text{ °C}$		15	A
Pulsed collector current ²⁾ , $T_C = 25\text{ °C}$	$I_{C, pulse}$	45	A
Diode forward current ¹⁾ , $T_C = 25\text{ °C}$	I_F	30	A
Diode forward current ¹⁾ , $T_C = 100\text{ °C}$		15	A
Diode pulsed current ²⁾ , $T_C = 25\text{ °C}$	$I_{F, pulse}$	45	A
Power dissipation ³⁾ , $T_C = 25\text{ °C}$	P_D	250	W
Operation and storage temperature	T_{stg}, T_{vj}	-55 to 175	$^{\circ}C$
Short circuit withstand time $V_{GE} = 15\text{ V}$, $V_{CC} \leq 400\text{ V}$ Allowed number of short circuits < 1000 Time between short circuits: $\geq 1.0\text{ S}$ $T_{vj} = 150\text{ °C}$	tsc	10	μs

Thermal Characteristics

Parameter	Symbol	Value	Unit
IGBT thermal resistance, junction-case	$R_{\theta JC}$	0.6	$^{\circ}C/W$
Diode thermal resistance, junction-case	$R_{\theta JC}$	2.0	$^{\circ}C/W$
Thermal resistance, junction-ambient ⁴⁾	$R_{\theta JA}$	75	$^{\circ}C/W$

Electrical Characteristics at $T_{vj}=25\text{ °C}$ unless otherwise specified

Parameter	Symbol	Min.	Typ.	Max.	Unit	Test condition
Collector-emitter breakdown voltage	$V_{(BR)CES}$	650			V	$V_{GE}=0\text{ V}$, $I_C=0.5\text{ mA}$
Collector-emitter saturation voltage	$V_{CE(sat)}$		1.65	2.0	V	$V_{GE}=15\text{ V}$, $I_C=15\text{ A}$ $T_{vj}=25\text{ °C}$
			1.8		V	$V_{GE}=15\text{ V}$, $I_C=15\text{ A}$, $T_{vj}=125\text{ °C}$
			1.9			$V_{GE}=15\text{ V}$, $I_C=15\text{ A}$, $T_{vj}=175\text{ °C}$
Gate-emitter threshold voltage	$V_{GE(th)}$	4.4	5.2	6.0	V	$V_{CE}=V_{GE}$, $I_D=0.5\text{ mA}$
Diode forward voltage	V_F		1.65	2.0	V	$V_{GE}=0\text{ V}$, $I_F=15\text{ A}$ $T_{vj}=25\text{ °C}$
			1.8			$V_{GE}=0\text{ V}$, $I_F=15\text{ A}$, $T_{vj}=125\text{ °C}$
			1.9			$V_{GE}=0\text{ V}$, $I_F=15\text{ A}$, $T_{vj}=175\text{ °C}$
Gate-emitter leakage current	I_{GES}			100	nA	$V_{CE}=0\text{ V}$, $V_{GE}=20\text{ V}$
Zero gate voltage collector current	I_{CES}			10	μA	$V_{CE}=650\text{ V}$, $V_{GE}=0\text{ V}$

Dynamic Characteristics

Parameter	Symbol	Min.	Typ.	Max.	Unit	Test condition
Input capacitance	C_{ies}		2015		pF	$V_{GE}=0\text{ V}$, $V_{CE}=25\text{ V}$, $f=100\text{ kHz}$
Output capacitance	C_{oes}		80		pF	
Reverse transfer capacitance	C_{res}		41		pF	
Turn-on delay time	$t_{d(on)}$		50		ns	$V_{GE}=15\text{ V}$, $V_{CC}=400\text{ V}$, $R_G=10\ \Omega$, $I_C=15\text{ A}$
Rise time	t_r		36		ns	
Turn-off delay time	$t_{d(off)}$		143		ns	
Fall time	t_f		94		ns	
Turn-on energy	E_{on}		0.62		mJ	
Turn-off energy	E_{off}		0.11		mJ	

Gate Charge Characteristics

Parameter	Symbol	Min.	Typ.	Max.	Unit	Test condition
Total gate charge	Q_g		73		nC	$V_{GE}=15\text{ V}$, $V_{CC}=520\text{ V}$, $I_C=15\text{ A}$
Gate-emitter charge	Q_{ge}		22		nC	
Gate-collector charge	Q_{gc}		36		nC	

Body Diode Characteristics

Parameter	Symbol	Min.	Typ.	Max.	Unit	Test condition
Diode reverse recovery time	t_{rr}		94		ns	$V_R=400\text{ V}$, $I_F=15\text{ A}$, $di_F/dt=500\text{ A}/\mu\text{s}$ $T_{vj}=25\text{ }^\circ\text{C}$
Diode reverse recovery charge	Q_{rr}		1.2		μC	
Diode peak reverse recovery current	I_{rrm}		21.7		A	

Note

- 1) Calculated continuous current based on maximum allowable junction temperature.
- 2) Repetitive rating; pulse width limited by max. junction temperature.
- 3) P_d is based on max. junction temperature, using junction-case thermal resistance.
- 4) The value of $R_{\theta JA}$ is measured with the device mounted on 1 in square FR-4 board with 2oz. Copper, in a still air environment with $T_a=25\text{ }^\circ\text{C}$.

Electrical Characteristics Diagrams

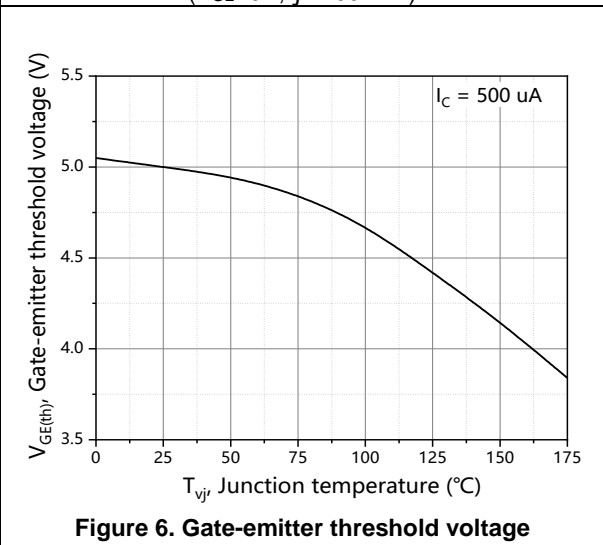
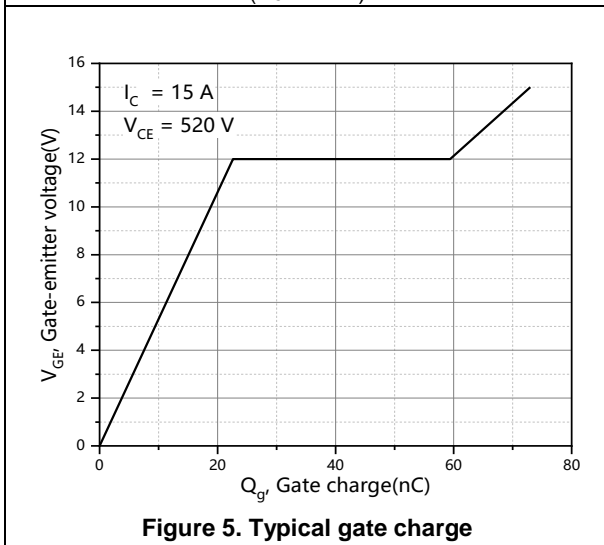
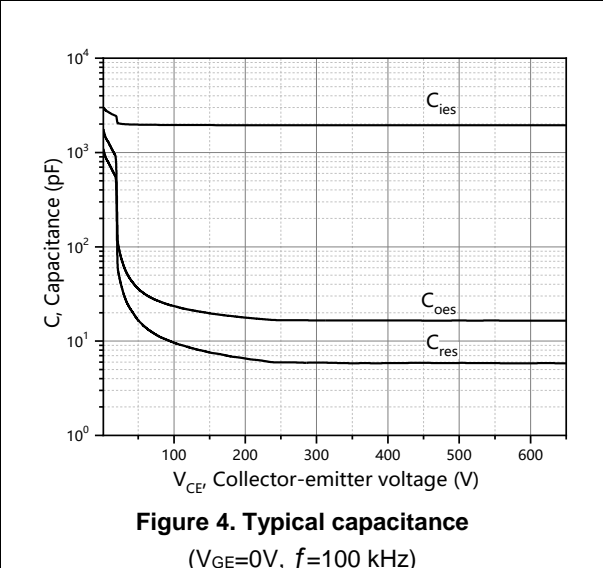
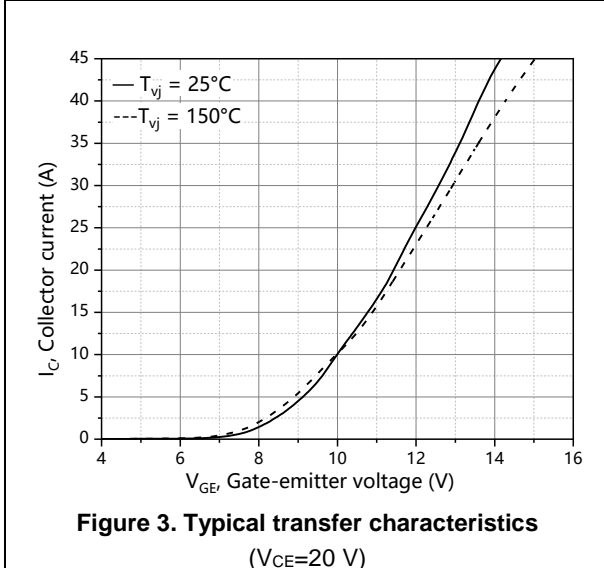
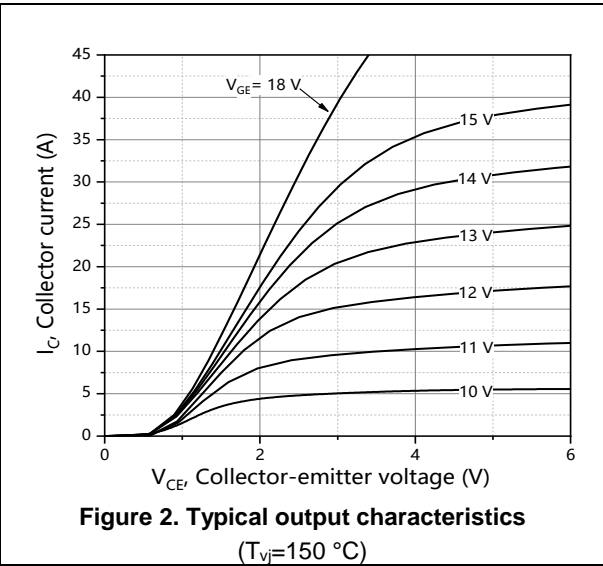
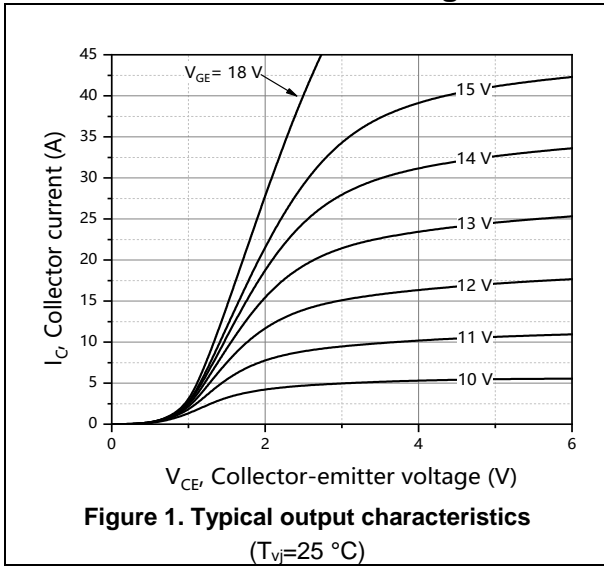

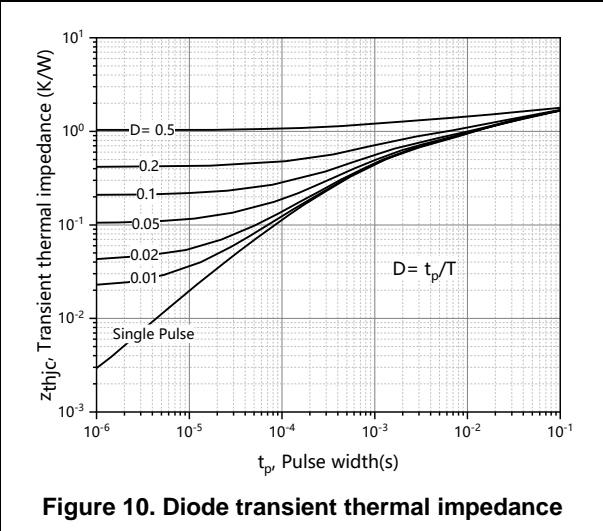
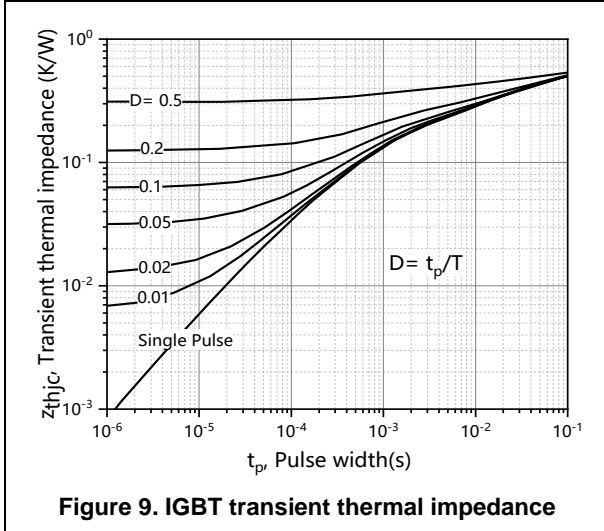
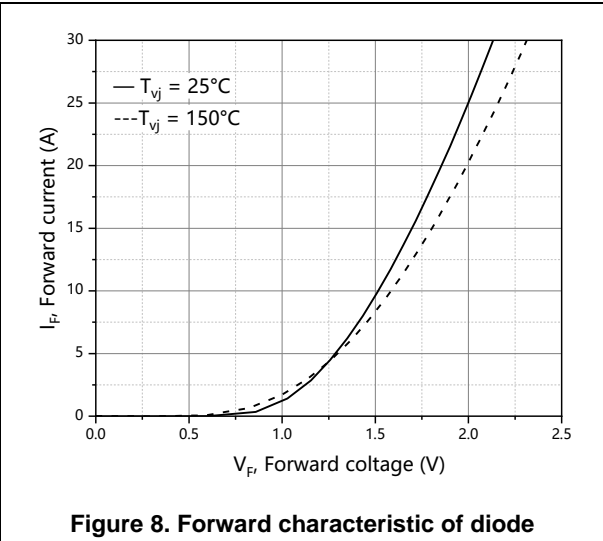
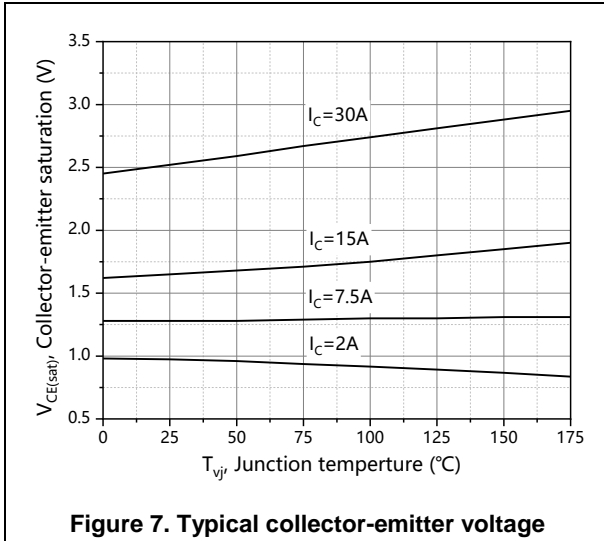

Package Information

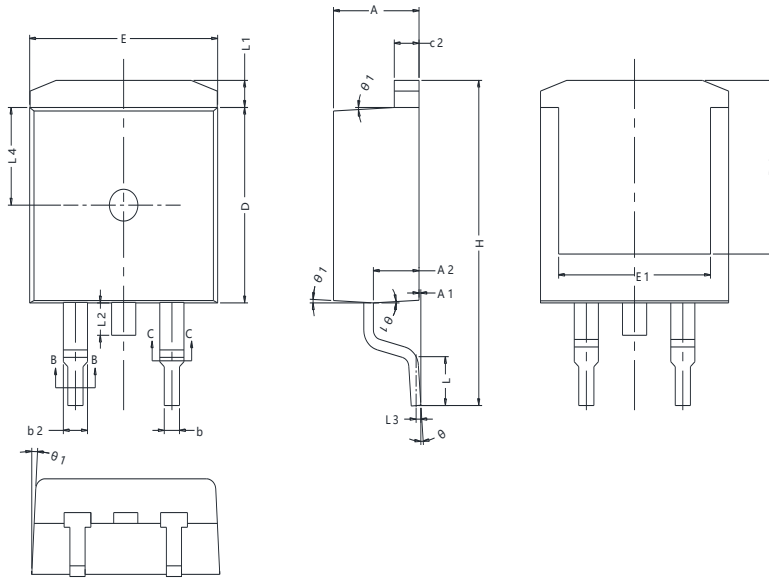

Symbol	mm		
	Min	Nom	Max
A	4.40	4.50	4.60
A1	0.00	0.10	0.25
A2	2.20	2.40	2.60
b	0.76	-	0.89
b2	1.23	-	1.37
c	0.47	-	0.60
c1	0.46	0.51	0.56
c2	1.25	1.30	1.35
D	9.10	9.20	9.30
D1	8.00	-	-
E	9.80	9.90	10.00
E1	7.80	-	-
e	2.54 BSC		
H	14.90	15.30	15.70
L	2.00	2.30	2.60
L1	1.17	1.27	1.40
L2	-	-	1.75
L3	0.25 BSC		
L4	4.60 REF		
θ	0°	-	8°
θ1	1°	3°	5°

Version 1: TO263-J package outline dimension

Ordering Information

Package Type	Units/ Reel	Reels/ Inner Box	Units/ Inner Box	Inner Boxes/ Carton Box	Units/ Carton Box
TO263-J	800	1	800	10	8000

Product Information

Product	Package	Pb Free	RoHS	Halogen Free
OST15N65KRF	TO263	yes	yes	yes

Legal Disclaimer

The information given in this document shall in no event be regarded as a guarantee of conditions or characteristics. With respect to any examples or hints given herein, any typical values stated herein and/or any information regarding the application of the device, Oriental Semiconductor hereby disclaims any and all warranties and liabilities of any kind, including without limitation, warranties of non-infringement of intellectual property rights of any third party.

For further information on technology, delivery terms and conditions and prices, please contact the Oriental Semiconductor sales representatives (www.orientalsemi.com).

© Oriental Semiconductor Co.,Ltd. All Rights Reserved 