

BIPOLAR ANALOG INTEGRATED CIRCUIT

μ PC8163TB

SILICON MMIC 2.0 GHz FREQUENCY UP-CONVERTER FOR CELLULAR TELEPHONE

DESCRIPTION

The μ PC8163TB is a silicon monolithic integrated circuit designed as frequency up-converter for cellular telephone transmitter stage. The μ PC8163TB has improved intermodulation performance and smaller package.

The μ PC8163TB is manufactured using NEC's 20 GHz fr NESAT™III silicon bipolar process. This process uses silicon nitride passivation film and gold electrodes. These materials can protect chip surface from external pollution and prevent corrosion/migration. Thus, this IC has excellent performance, uniformity and reliability.

FEATURES

- Recommended operating frequency : $f_{RFout} = 0.8 \text{ GHz to } 2.0 \text{ GHz}$, $f_{iFin} = 50 \text{ MHz to } 300 \text{ MHz}$
- Supply voltage : $V_{CC} = 2.7 \text{ to } 3.3 \text{ V}$
- High-density surface mounting : 6-pin super minimold package
- Higher IP₃ : OIP₃ = +9.5 dBm @ $f_{RFout} = 830 \text{ MHz}$
- Minimized carrier leakage : Due to double balanced mixer

APPLICATIONS

- Digital cellular phones

ORDERING INFORMATION

Part Number	Package	Supplying Form
μ PC8163TB-E3	6-pin super minimold	Embossed tape 8 mm wide. Pin 1, 2, 3 face to tape perforation side. Qty 3 kp/reel

Remark To order evaluation samples, please contact your local NEC sales office.
(Part number for sample order: μ PC8163TB)

Caution Electro-static sensitive device

The information in this document is subject to change without notice. Before using this document, please confirm that this is the latest version.

Not all devices/types available in every country. Please check with local NEC representative for availability and additional information.

PIN CONNECTIONS

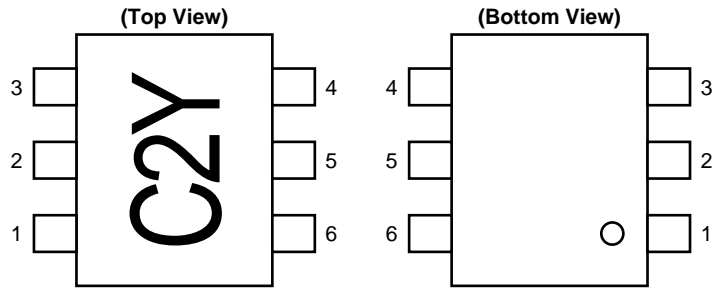

Pin No.	Pin Name
1	IFinput
2	GND
3	LOinput
4	GND
5	V _{CC}
6	RFoutput

SERIES PRODUCTS (T_A = +25°C, V_{CC} = V_{RFout} = 3.0 V, Z_L = Z_S = 50 Ω)

Type	Part No.	V _{CC} (V)	I _{CC} (mA)	CG1 (dB)	CG2 (dB)	P _{O(sat)} 1 (dBm)	P _{O(sat)} 2 (dBm)	OIP ₃ 1 (dBm)	OIP ₃ 2 (dBm)
High IP ₃	μ PC8106TB	2.7 to 5.5	9	9	7	-2	-4	+5.5	+2.0
Low Power Consumption	μ PC8109TB	2.7 to 5.5	5	6	4	-5.5	-7.5	+1.5	-1.0
Higher IP ₃	μ PC8163TB	2.7 to 3.3	16.5	9	5.5	0.5	-2	+9.5	+6.0

Caution The above table lists the typical performance of each model. See ELECTRICAL CHARACTERISTICS for the test conditions.

BLOCK DIAGRAM (FOR THE μ PC8163TB)

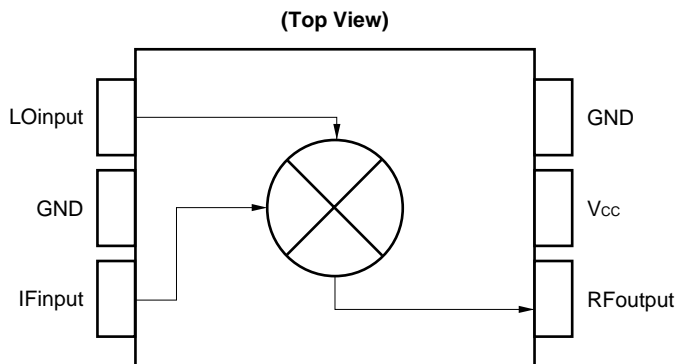

SYSTEM APPLICATION EXAMPLES (SCHEMATICS OF IC LOCATION IN THE SYSTEM)

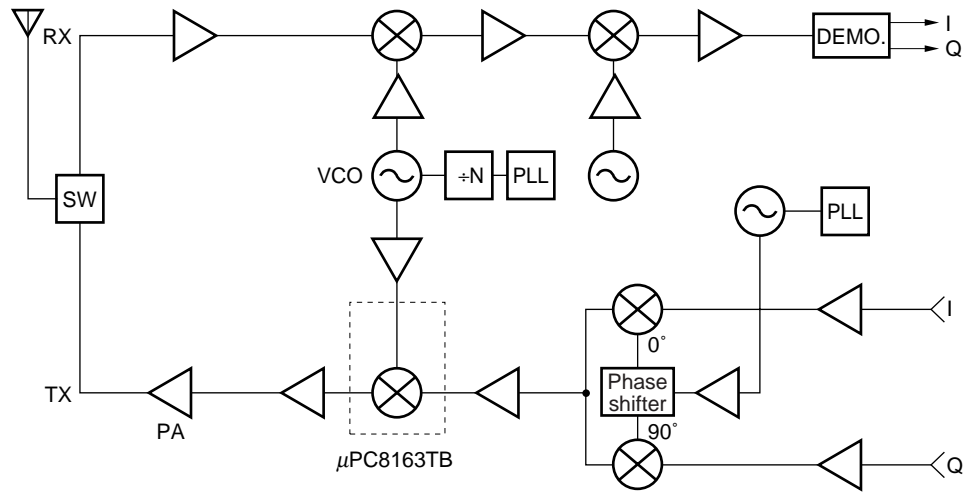

PIN EXPLANATION

Pin No.	Pin Name	Applied Voltage V	Pin Voltage V ^{Note}	Function and Explanation	Equivalent Circuit
1	IFinput	—	1.2	This pin is IF input to double balanced mixer (DBM). The input is designed as high impedance. The circuit contributes to suppress spurious signal. Also this symmetrical circuit can keep specified performance insensitive to process-condition distribution. For above reason, double balanced mixer is adopted.	
2 4	GND	0	—	GND pin. Ground pattern on the board should be formed as wide as possible. Track Length should be kept as short as possible to minimize ground impedance.	
3	LOinput	—	2.1	Local input pin. Recommendable input level is -10 to 0 dBm.	
5	V _{cc}	2.7 to 3.3	—	Supply voltage pin.	
6	RFoutput	Same bias as V _{cc} through external inductor	—	This pin is RF output from DBM. This pin is designed as open collector. Due to the high impedance output, this pin should be externally equipped with LC matching circuit to next stage.	

Note Each pin voltage is measured with $V_{CC} = V_{RFout} = 3.0\text{ V}$.

ABSOLUTE MAXIMUM RATINGS

Parameter	Symbol	Test Conditions	Rating	Unit
Supply Voltage	V _{CC}	T _A = +25°C, Pin 5 and 6	3.6	V
Power Dissipation of Package	P _D	Mounted on double-sided copperclad 50 × 50 × 1.6 mm epoxy glass PWB T _A = +85°C	200	mW
Operating Ambient Temperature	T _A		-40 to +85	°C
Storage Temperature	T _{stg}		-55 to +150	°C
Maximum Input Power	P _{in}		+10	dBm

RECOMMENDED OPERATING CONDITIONS

Parameter	Symbol	Test Conditions	MIN.	TYP.	MAX.	Unit
Supply Voltage	V _{CC}	The same voltage should be applied to pin 5 and 6	2.7	3.0	3.3	V
Operating Ambient Temperature	T _A		-40	+25	+85	°C
Local Input Level	P _{LOin}	Z _s = 50 Ω (without matching)	-10	-5	0	dBm
RF Output Frequency	f _{RFout}	With external matching circuit	0.8	-	2.0	GHz
IF Input Frequency	f _{IFin}		50	-	300	MHz

ELECTRICAL CHARACTERISTICS

(T_A = +25°C, V_{CC} = V_{RFout} = 3.0 V, f_{IFin} = 150 MHz, P_{LOin} = -5 dBm)

Parameter	Symbol	Conditions	MIN.	TYP.	MAX.	Unit
Circuit Current	I _{CC}	No Signal	11.5	16.5	23	mA
Conversion Gain 1	CG1	f _{RFout} = 830 MHz, P _{IFin} = -20 dBm	6	9	12	dB
Conversion Gain 2	CG2	f _{RFout} = 1.9 GHz, P _{IFin} = -20 dBm	2.5	5.5	8.5	dB
Maximum RF Output Power 1	P _{O(sat) 1}	f _{RFout} = 830 MHz, P _{IFin} = 0 dBm	-1.5	0.5	-	dBm
Maximum RF Output Power 2	P _{O(sat) 2}	f _{RFout} = 1.9 GHz, P _{IFin} = 0 dBm	-4.5	-2	-	dBm

OTHER CHARACTERISTICS, FOR REFERENCE PURPOSES ONLY

(T_A = +25°C, V_{CC} = V_{RFout} = 3.0 V, P_{LOin} = -5 dBm)

Parameter	Symbol	Conditions	Data	Unit
Input Third Order Distortion Intercept Point	IIP _{3 1}	f _{IFin1} = 150.0 MHz f _{RFout} = 830 MHz	0.5	dBm
	IIP _{3 2}	f _{IFin2} = 150.4 MHz f _{RFout} = 1.9 GHz	0.5	
Output Third-Order Distortion Intercept Point	OIP _{3 1}	f _{IFin1} = 150.0 MHz f _{RFout} = 830 MHz	+9.5	dBm
	OIP _{3 2}	f _{IFin2} = 150.4 MHz f _{RFout} = 1.9 GHz	+6.0	
SSB Noise Figure	SSB NF	f _{RFout} = 830 MHz, f _{IFin} = 150 MHz	12.5	dB

TEST CIRCUIT 1 (f_{RFout} = 830 MHz)

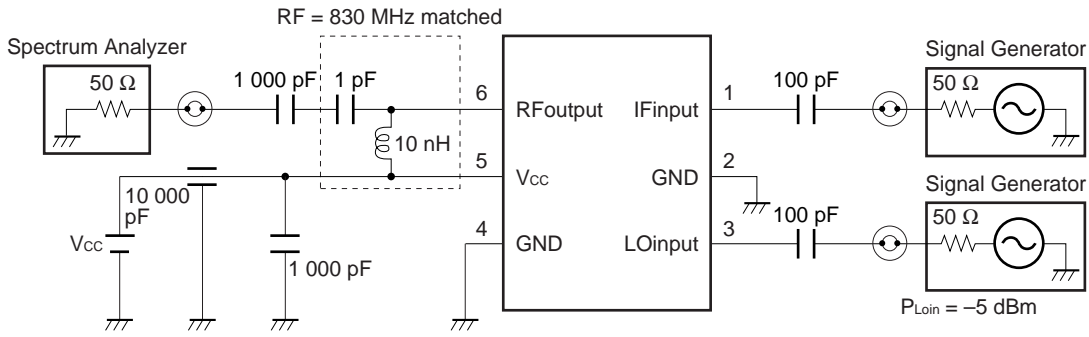
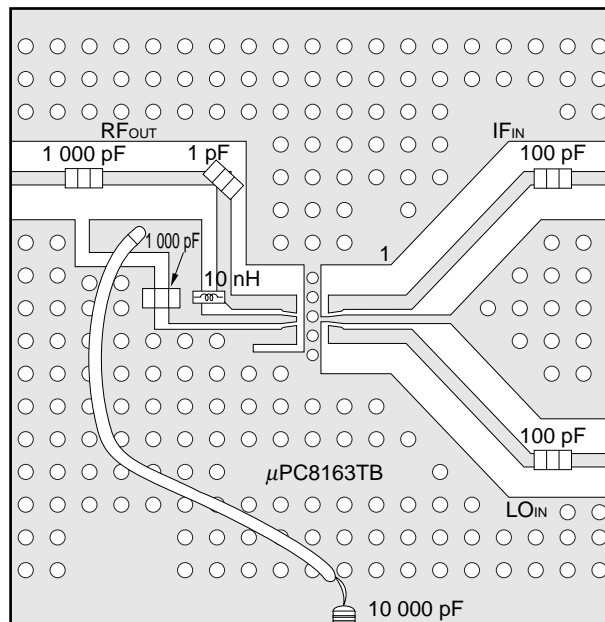

ILLUSTRATION OF TEST CIRCUIT 1 ASSEMBLED ON EVALUATION BOARD



EVALUATION BOARD CHARACTERS

- (1) 35 μm thick double-sided copper clad 35 × 42 × 0.4 mm polyimide board
- (2) Back side: GND pattern
- (3) Solder plated patterns
- (4) ○: Through holes

ATTENTION Test circuit or print pattern in this sheet is for testing IC characteristics.

In the case of actual system application, external circuits including print pattern and matching circuit constant of output port should be designed in accordance with IC's S parameters and environmental components.

TEST CIRCUIT 2 ($f_{RFout} = 1.9$ GHz)

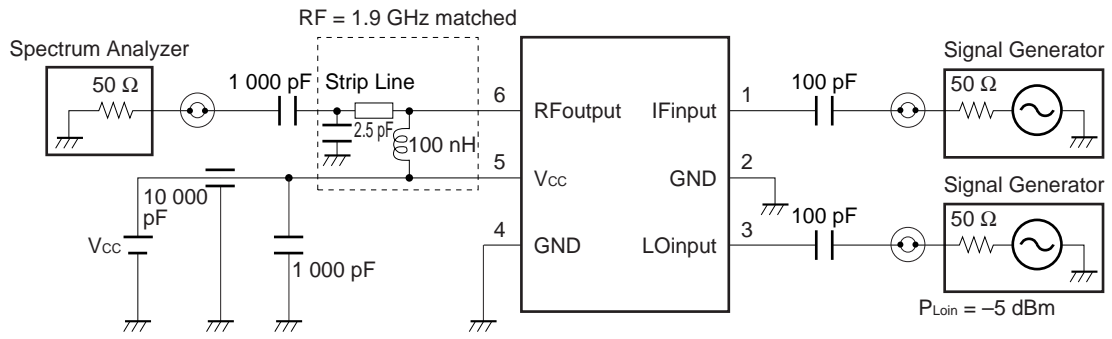

★ **ILLUSTRATION OF TEST CIRCUIT 2 ASSEMBLED ON EVALUATION BOARD**

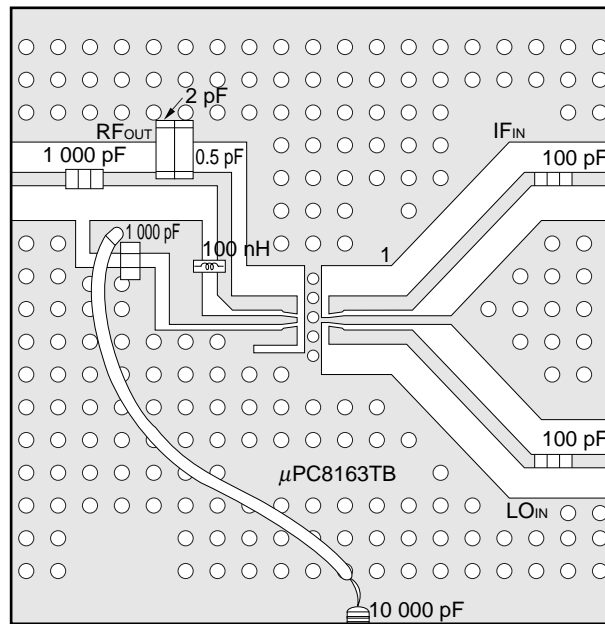

EVALUATION BOARD CHARACTERS

- (1) 35 μ m thick double-sided copper clad 35 × 42 × 0.4 mm polyimide board
- (2) Back side: GND pattern
- (3) Solder plated patterns
- (4) o: Through holes

★ TYPICAL CHARACTERISTICS (T_A = +25°C, unless otherwise specified V_{CC} = V_{RFout})

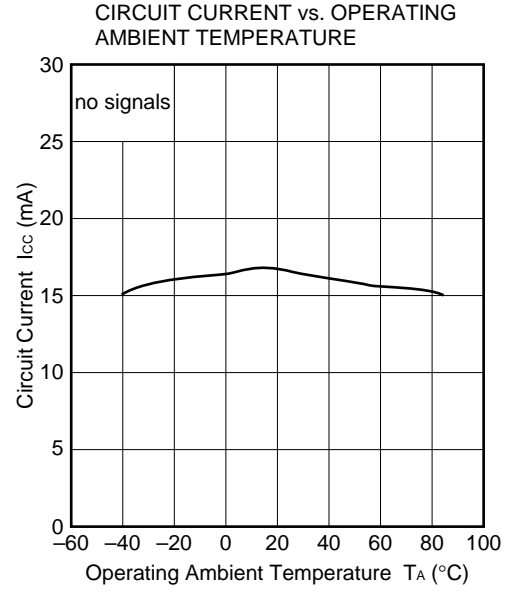
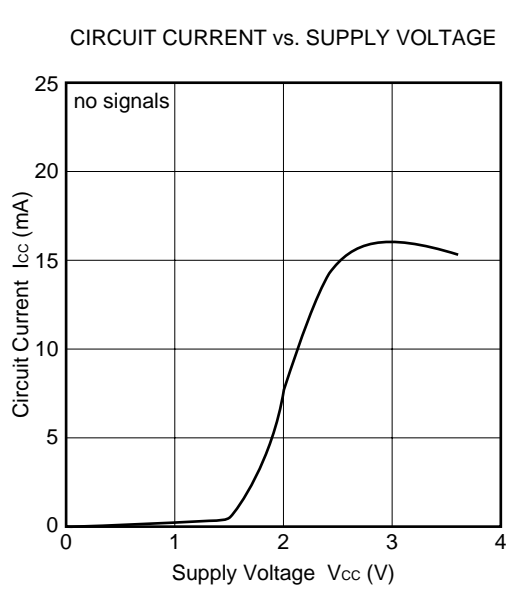

★ S-PARAMETER FOR MATCHED RF OUTPUT (V_{CC} = V_{RFout} = 3.0 V) – with TEST CIRCUITS 1 and 2 – (monitored at RF connector on board)

- RF output matched at 830 MHz

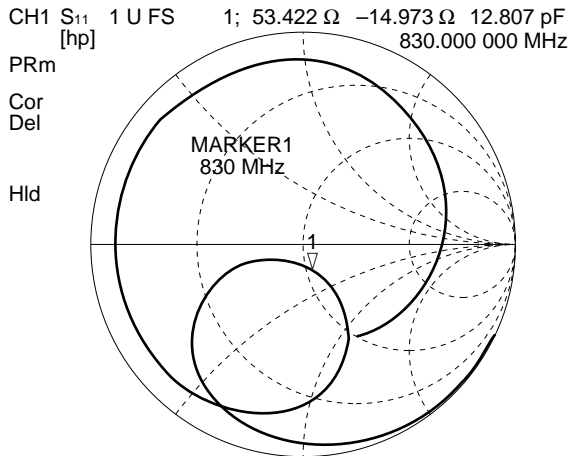

START 100.000 000 MHz STOP 3 000.000 000 MHz

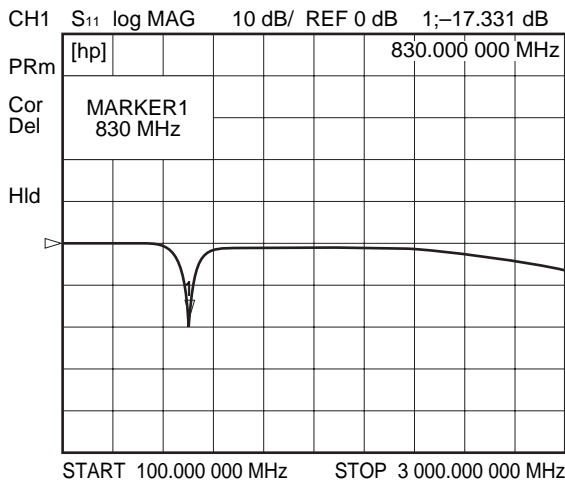

- RF output matched at 1.9 GHz

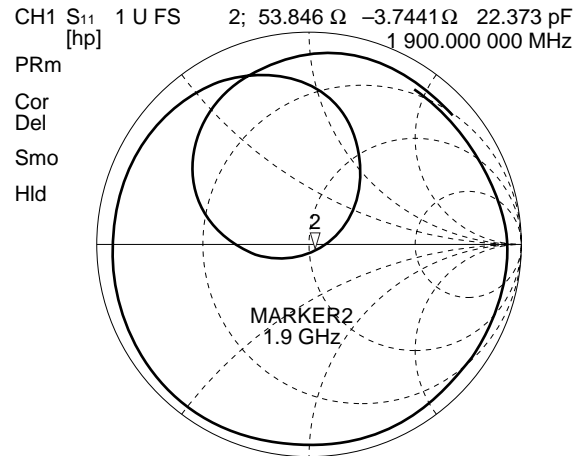

START 100.000 000 MHz STOP 3 000.000 000 MHz

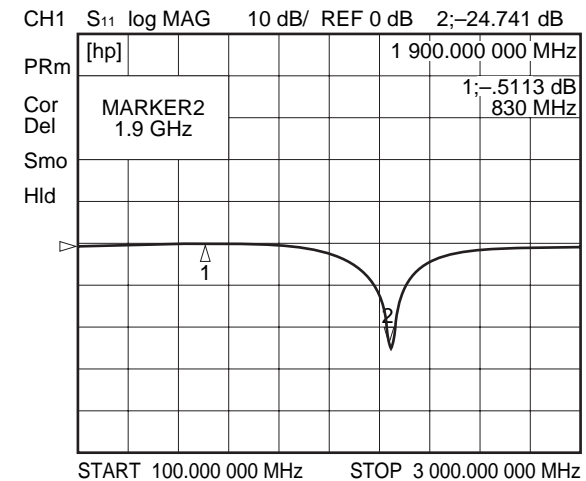

★ S-PARAMETERS FOR EACH PORT ($V_{CC} = V_{RFout} = 3.0\text{ V}$)

LO port

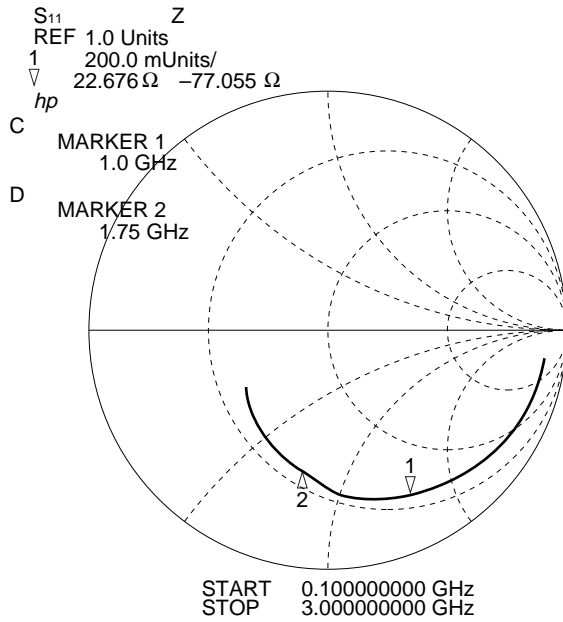

RF port (no matching)

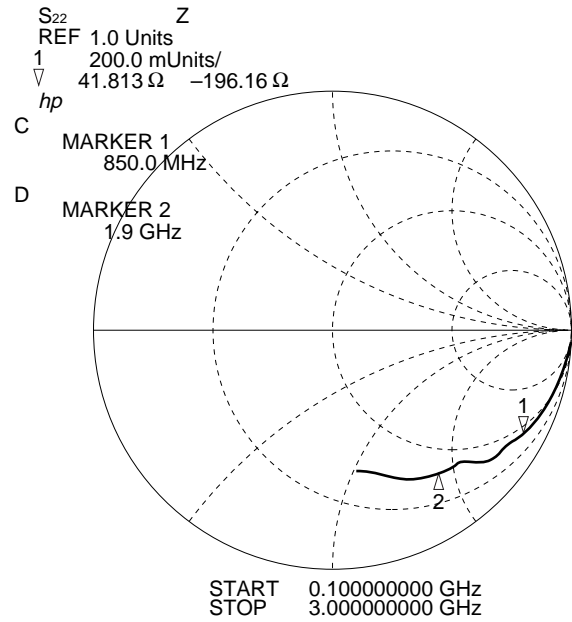

IF port

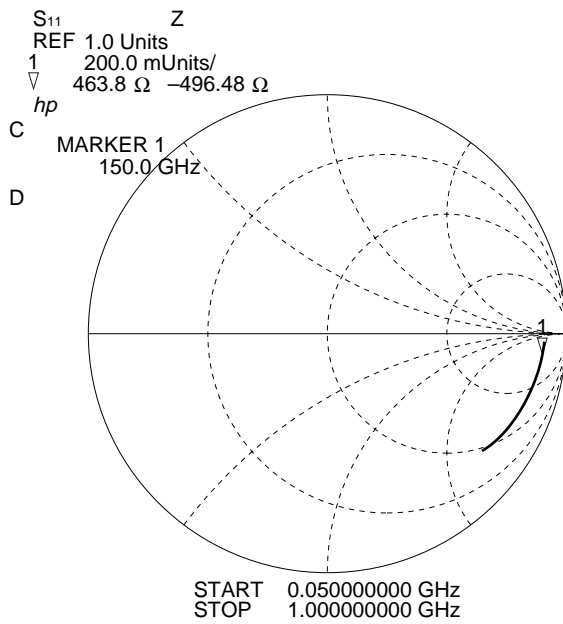

CONVERSION GAIN vs. LO INPUT LEVEL

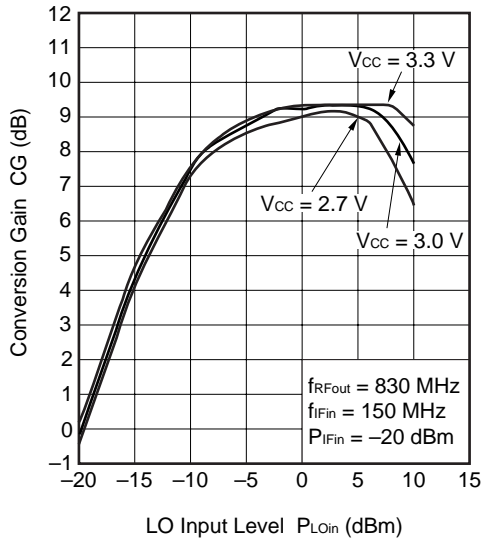

CONVERSION GAIN vs. LO INPUT LEVEL

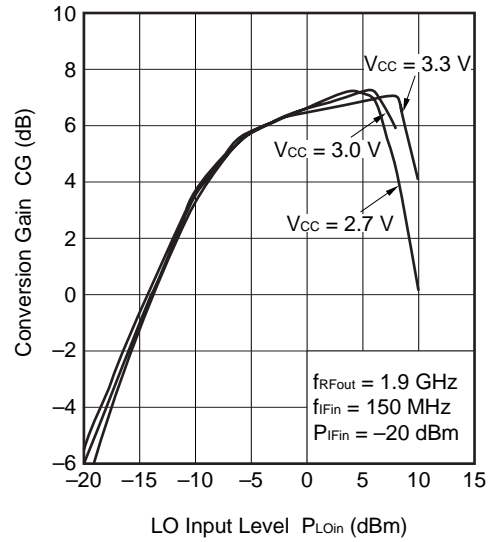

CONVERSION GAIN vs. LO INPUT LEVEL

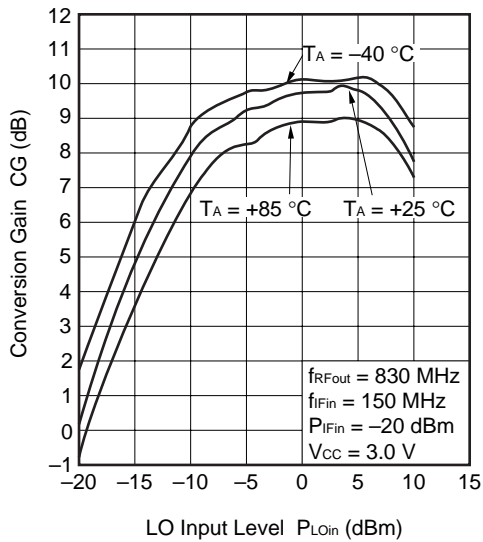

CONVERSION GAIN vs. LO INPUT LEVEL

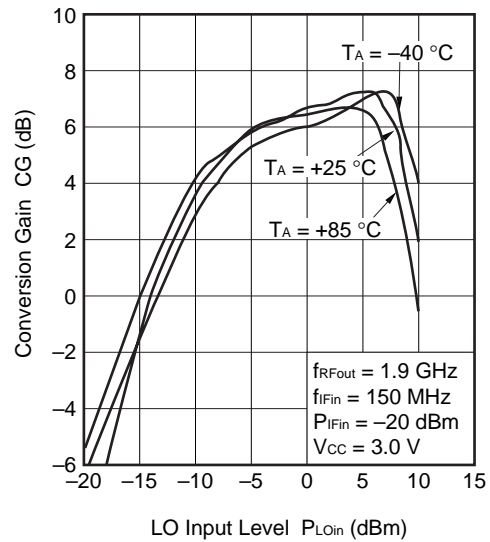

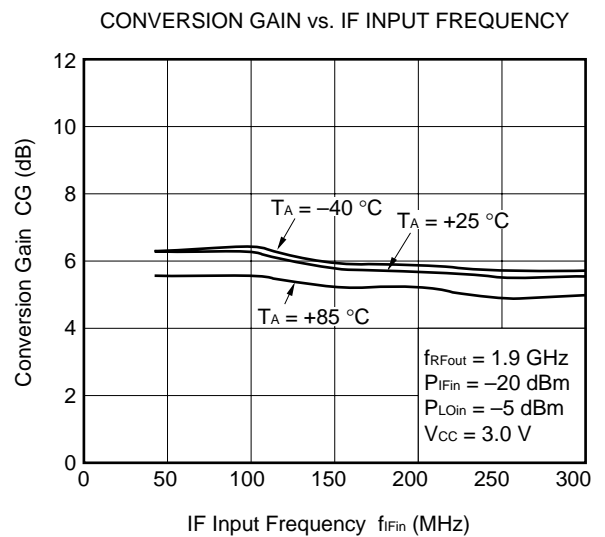
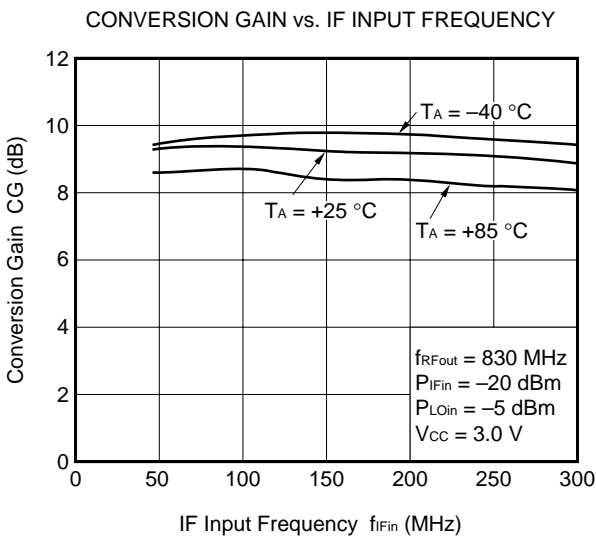
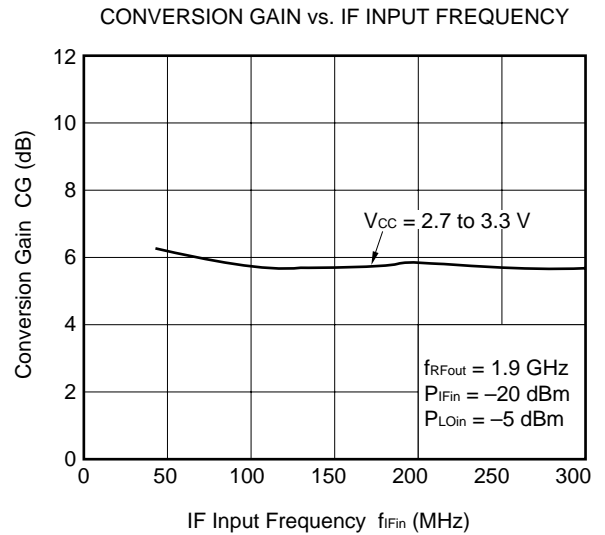
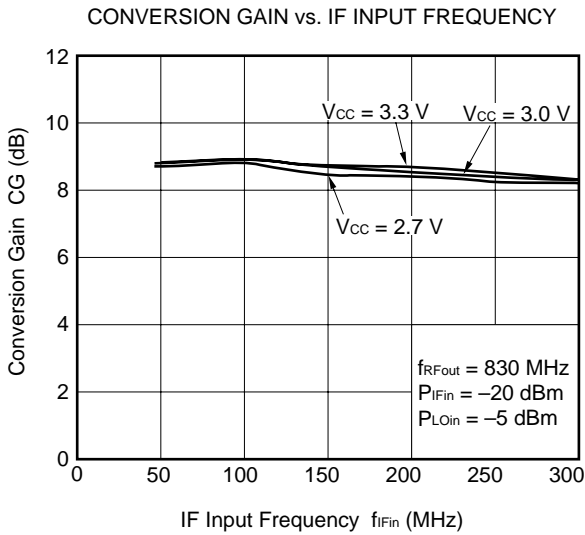

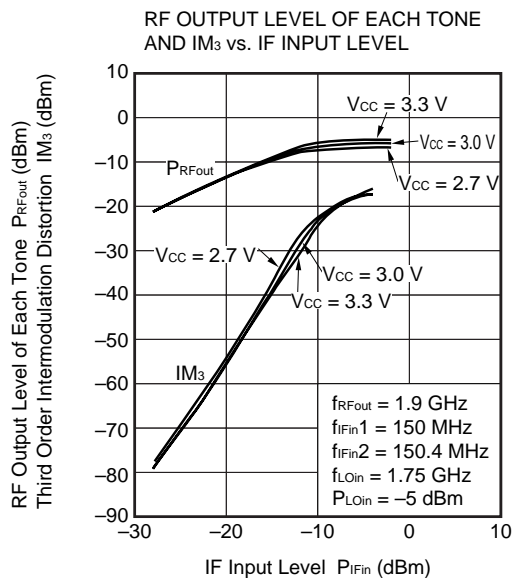
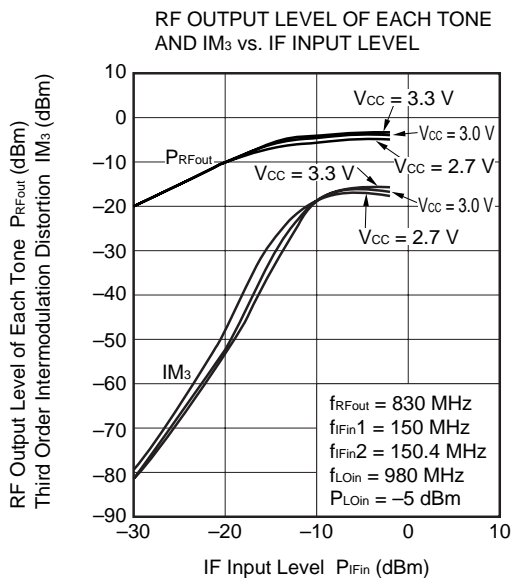
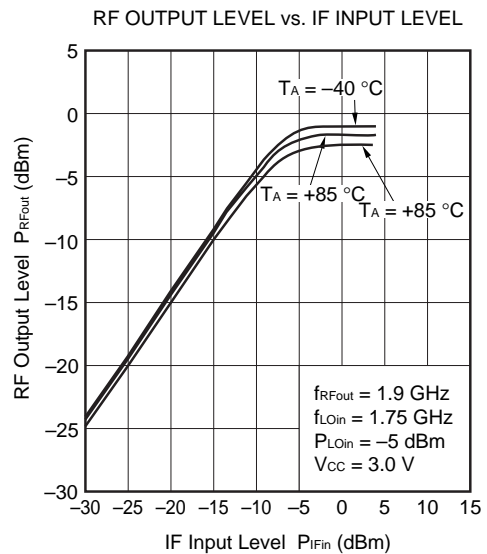
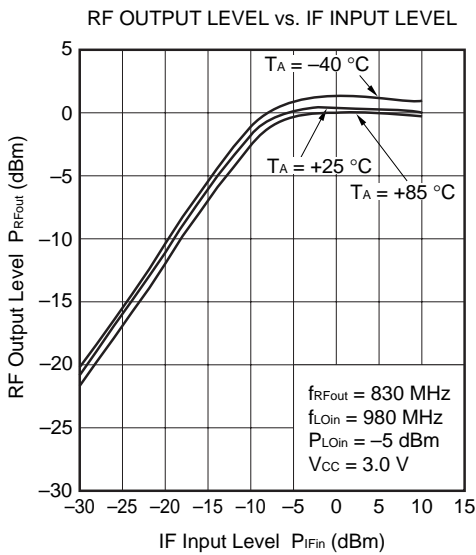
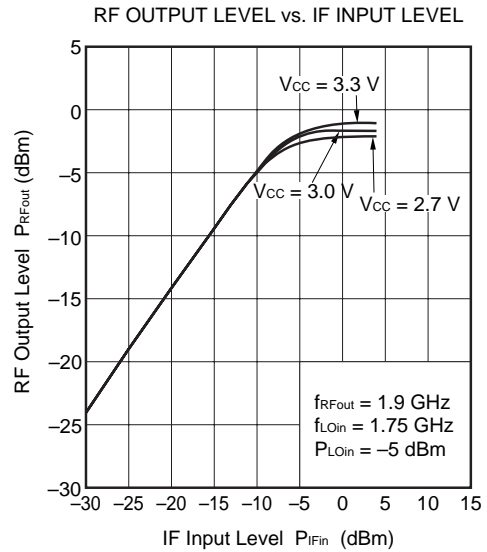
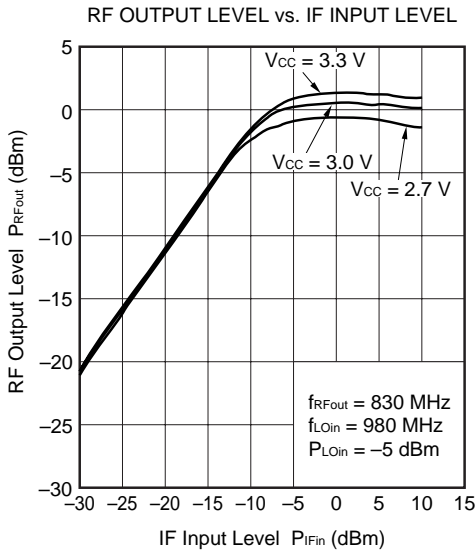

LO LEAKAGE AT IF PIN vs. LO INPUT FREQUENCY

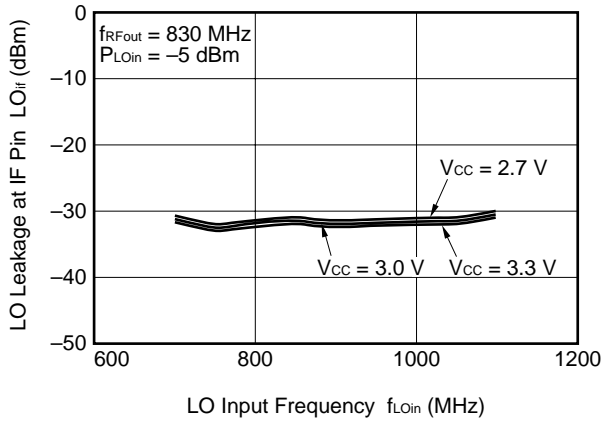

LO LEAKAGE AT IF PIN vs. LO INPUT FREQUENCY

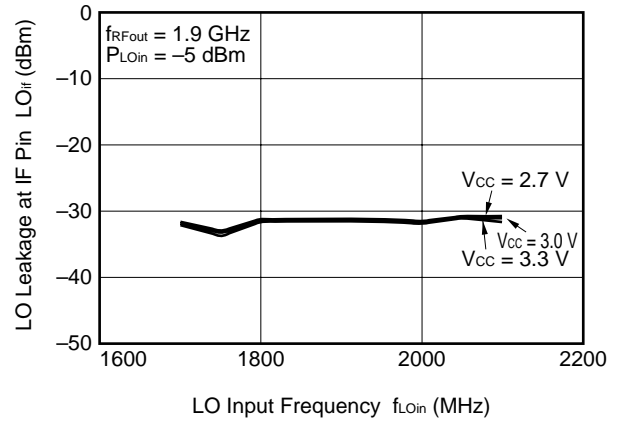

LO LEAKAGE AT RF PIN vs. LO INPUT FREQUENCY

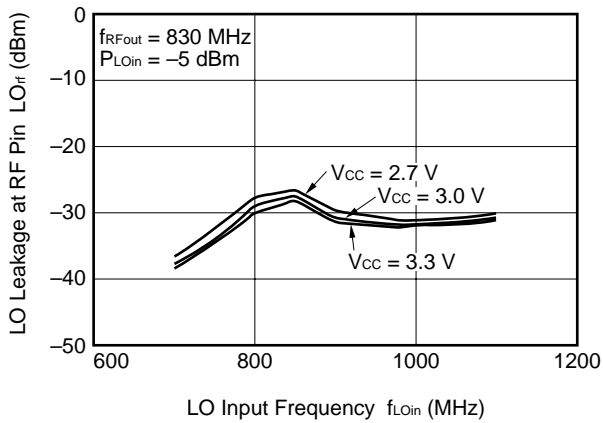

LO LEAKAGE AT RF PIN vs. LO INPUT FREQUENCY

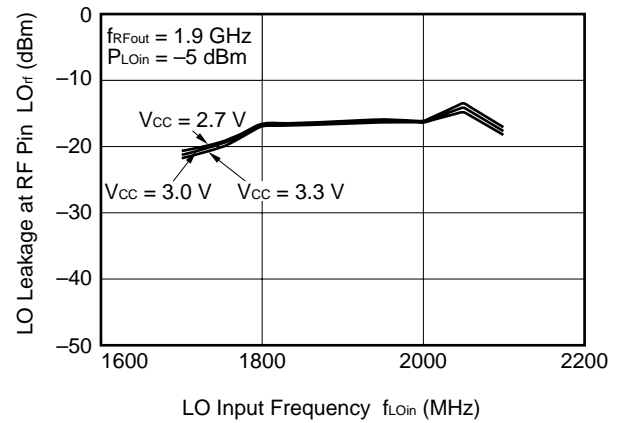

PACKAGE DIMENSIONS

6 pin super minimold (Unit: mm)

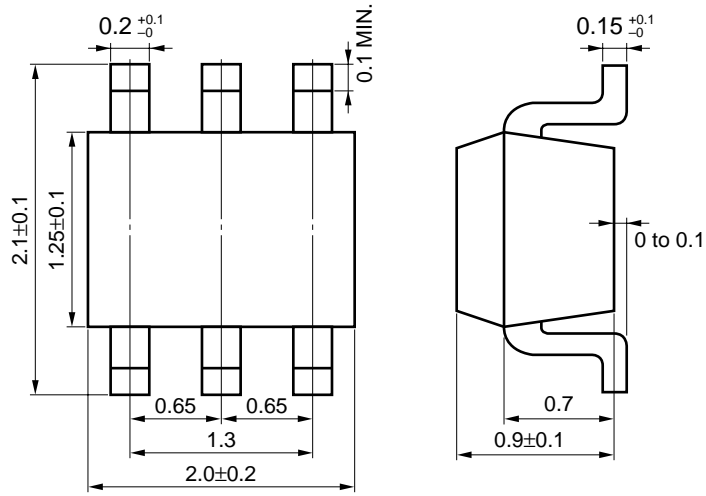

NOTE ON CORRECT USE

- (1) Observe precautions for handling because of electrostatic sensitive devices.
- (2) Form a ground pattern as wide as possible to keep the minimum ground impedance (to prevent undesired oscillation).
- (3) Keep the track length of the ground pins as short as possible.
- (4) Connect a bypass capacitor (example: 1 000 pF) to the Vcc pin.

RECOMMENDED SOLDERING CONDITIONS

This product should be soldered under the following recommended conditions. For soldering methods and conditions other than those recommended below, contact your NEC sales representative.

Soldering Method	Soldering Conditions	Recommended Condition Symbol
Infrared Reflow	Package peak temperature: 235 °C or below Time: 30 seconds or less (at 210 °C) Count: 3, Exposure limit: None ^{Note}	IR35-00-3
VPS	Package peak temperature: 215 °C or below Time: 40 seconds or less (at 200 °C) Count: 3, Exposure limit: None ^{Note}	VP15-00-3
Wave Soldering	Soldering bath temperature: 260 °C or below Time: 10 seconds or less Count: 1, Exposure limit: None ^{Note}	WS60-00-1
Partial Heating	Pin temperature: 300 °C Time: 3 seconds or less (per side of device) Exposure limit: None ^{Note}	—

Note After opening the dry pack, keep it in a place below 25 °C and 65 % RH for the allowable storage period.

Caution Do not use different soldering methods together (except for partial heating).

For details of recommended soldering conditions for surface mounting, refer to information document SEMICONDUCTOR DEVICE MOUNTING TECHNOLOGY MANUAL (C10535E).

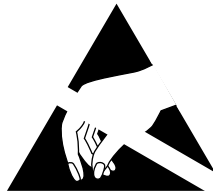

ATTENTION

OBSERVE PRECAUTIONS
FOR HANDLING
ELECTROSTATIC
SENSITIVE
DEVICES

NESAT (NEC Silicon Advanced Technology) is a trademark of NEC Corporation.

- **The information in this document is subject to change without notice. Before using this document, please confirm that this is the latest version.**
- No part of this document may be copied or reproduced in any form or by any means without the prior written consent of NEC Corporation. NEC Corporation assumes no responsibility for any errors which may appear in this document.
- NEC Corporation does not assume any liability for infringement of patents, copyrights or other intellectual property rights of third parties by or arising from use of a device described herein or any other liability arising from use of such device. No license, either express, implied or otherwise, is granted under any patents, copyrights or other intellectual property rights of NEC Corporation or others.
- Descriptions of circuits, software, and other related information in this document are provided for illustrative purposes in semiconductor product operation and application examples. The incorporation of these circuits, software, and information in the design of the customer's equipment shall be done under the full responsibility of the customer. NEC Corporation assumes no responsibility for any losses incurred by the customer or third parties arising from the use of these circuits, software, and information.
- While NEC Corporation has been making continuous effort to enhance the reliability of its semiconductor devices, the possibility of defects cannot be eliminated entirely. To minimize risks of damage or injury to persons or property arising from a defect in an NEC semiconductor device, customers must incorporate sufficient safety measures in its design, such as redundancy, fire-containment, and anti-failure features.
- NEC devices are classified into the following three quality grades:
"Standard", "Special", and "Specific". The Specific quality grade applies only to devices developed based on a customer designated "quality assurance program" for a specific application. The recommended applications of a device depend on its quality grade, as indicated below. Customers must check the quality grade of each device before using it in a particular application.

Standard: Computers, office equipment, communications equipment, test and measurement equipment, audio and visual equipment, home electronic appliances, machine tools, personal electronic equipment and industrial robots

Special: Transportation equipment (automobiles, trains, ships, etc.), traffic control systems, anti-disaster systems, anti-crime systems, safety equipment and medical equipment (not specifically designed for life support)

Specific: Aircraft, aerospace equipment, submersible repeaters, nuclear reactor control systems, life support systems or medical equipment for life support, etc.

The quality grade of NEC devices is "Standard" unless otherwise specified in NEC's Data Sheets or Data Books. If customers intend to use NEC devices for applications other than those specified for Standard quality grade, they should contact an NEC sales representative in advance.