

FEATURES

- . Complementary to 2SC1627A.
- . Driver Stage Application of 30 to 35 Watts Amplifiers.

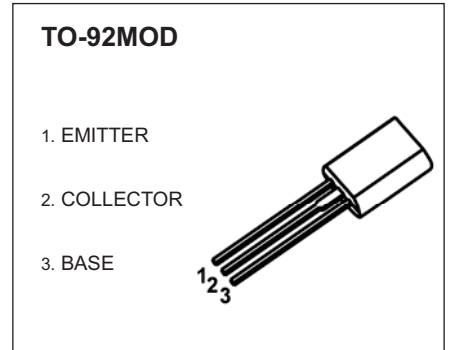

MARKING



A817A=Device code
Solid dot = Green molding compound device, if none, the normal device
XXX=Code

Equivalent Circuit

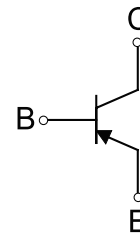

ORDERING INFORMATION

Part Number	Package	Packing Method	Pack Quantity
2SA817A	TO-92MOD	Bulk	500pcs/Bag
2SA817A-TA	TO-92MOD	Tape	2000pcs/Box

MAXIMUM RATINGS (T_a=25°C unless otherwise noted)

Symbol	Parameter	Value	Unit
V _{CBO}	Collector-Base Voltage	-80	V
V _{CEO}	Collector-Emitter Voltage	-80	V
V _{EBO}	Emitter-Base Voltage	-5	V
I _C	Collector Current -Continuous	-0.4	A
P _D	Collector Power Dissipation	800	mW
R _{θJA}	Thermal Resistance from Junction to Ambient	156	°C /W
T _J , T _{stg}	Operation Junction and Storage Temperature Range	-55~+150	°C

ELECTRICAL CHARACTERISTICS

$T_a=25^\circ\text{C}$ unless otherwise specified

Parameter	Symbol	Test conditions	Min	Typ	Max	Unit
Collector-base breakdown voltage	$V_{(BR)CBO}$	$I_C = -100\ \mu\text{A}$, $I_E = 0$	-80			V
Collector-emitter breakdown voltage	$V_{(BR)CEO}$	$I_C = -5\ \text{mA}$, $I_B = 0$	-80			V
Emitter-base breakdown voltage	$V_{(BR)EBO}$	$I_E = -100\ \mu\ \text{A}$, $I_C = 0$	-5			V
Collector cut-off current	I_{CBO}	$V_{CB} = -50\ \text{V}$, $I_E = 0$			-0.1	$\mu\ \text{A}$
Collector cut-off current	I_{EBO}	$V_{EB} = -5\text{V}$, $I_B = 0$			-0.1	$\mu\ \text{A}$
DC current gain	$h_{FE(1)}$	$V_{CE} = -2\text{V}$, $I_C = -50\text{mA}$	70		240	
	$h_{FE(2)}$	$V_{CE} = -2\text{V}$, $I_C = -200\text{mA}$	40			
Collector-emitter saturation voltage	$V_{CE(sat)}$	$I_C = -200\ \text{mA}$, $I_B = -20\text{mA}$			-0.4	V
Base-emitter voltage	V_{BE}	$V_{CE} = -2\text{V}$, $I_C = -5\text{mA}$	-0.55		-0.8	V
Transition frequency	f_T	$V_{CE} = -10\text{V}$, $I_C = -10\text{mA}$		100		MHz
Out capacitance	Cob	$V_{CB} = -10\ \text{V}$, $f = 1\text{MHz}$		14		pF

CLASSIFICATION OF $h_{FE(1)}$

Rank	O	Y
Range	70-140	120 - 240

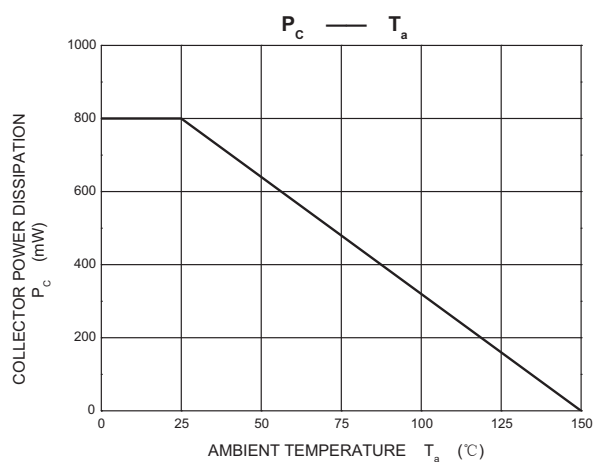
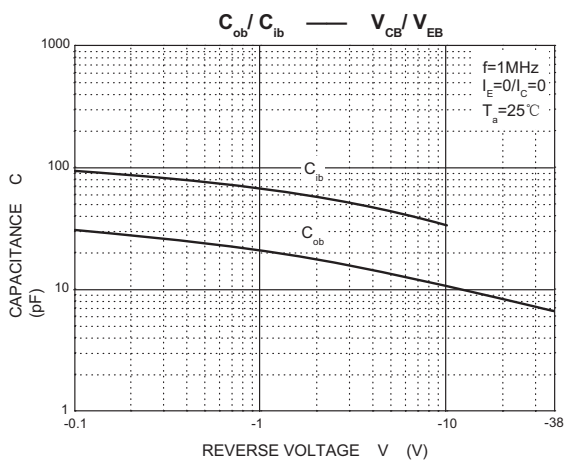
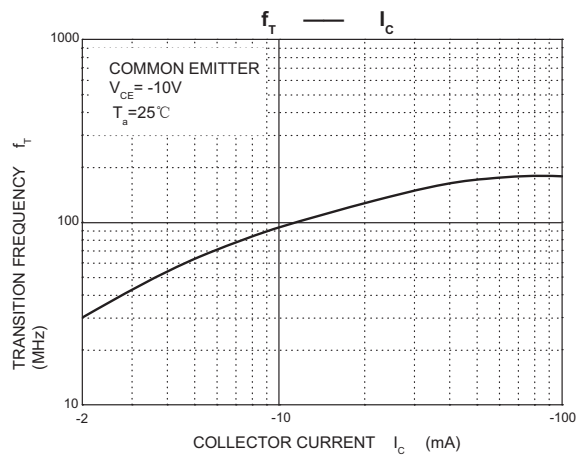
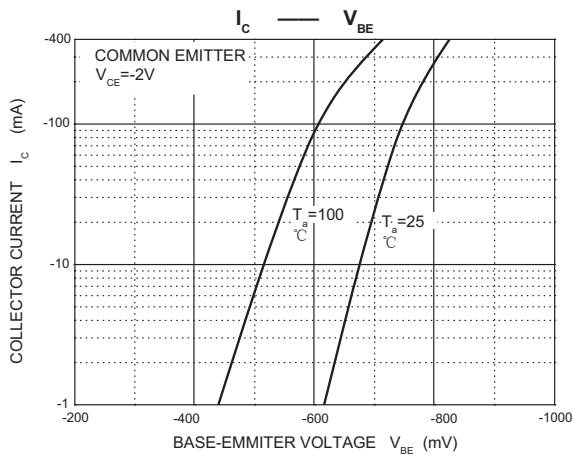
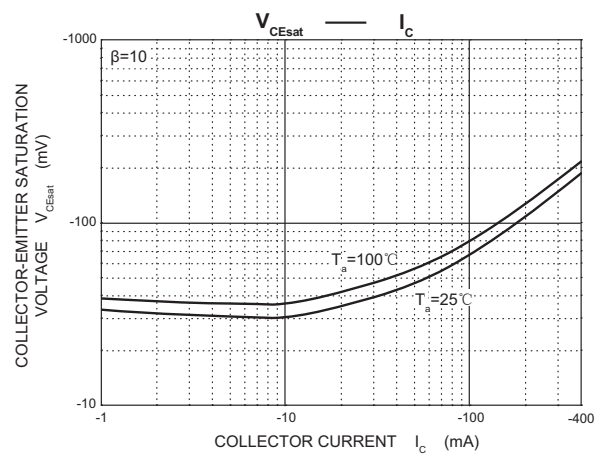
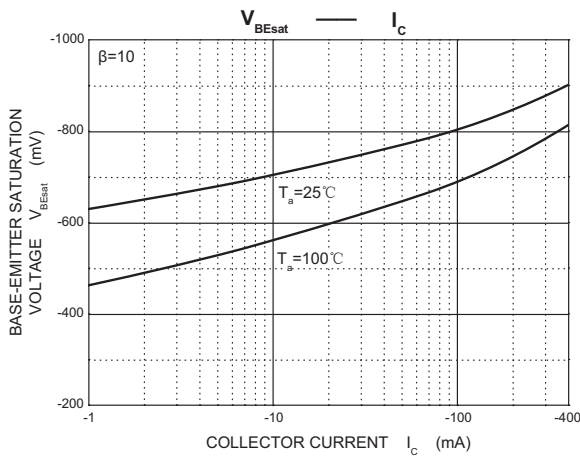
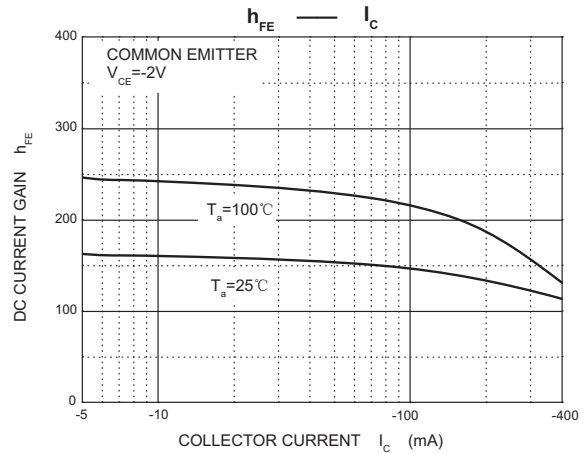
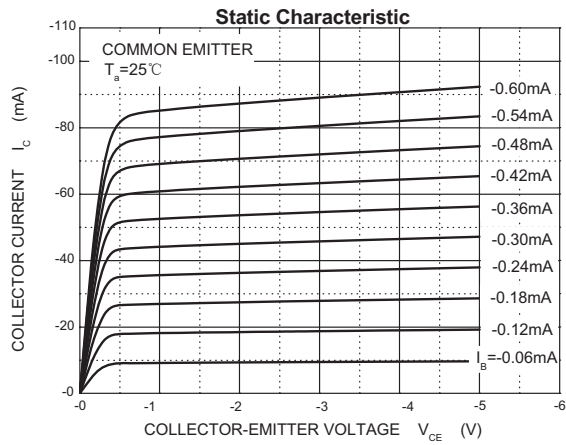

TO-92MOD Package Outline Dimensions

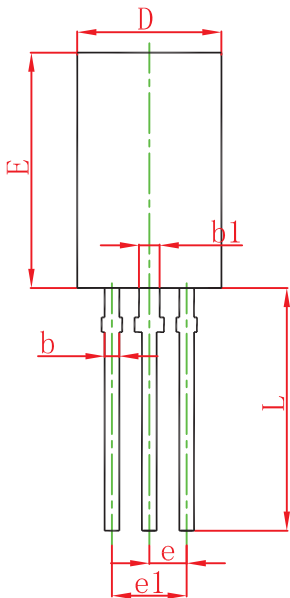
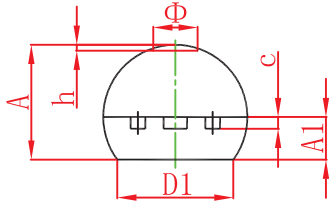

Symbol	Dimensions In Millimeters		Dimensions In Inches	
	Min.	Max.	Min.	Max.
A	4.800	5.000	0.189	0.197
A1	1.730	2.030	0.068	0.080
b	0.440	0.600	0.017	0.024
b1	0.940	1.100	0.037	0.043
c	0.350	0.450	0.014	0.018
D	5.900	6.100	0.232	0.240
D1	4.000		0.157	
E	8.500	8.700	0.335	0.343
e	1.500 TYP.		0.059 TYP.	
e1	2.900	3.100	0.114	0.122
L	13.800	14.200	0.543	0.559
Φ		1.600		0.063
h	0.000	0.380	0.000	0.015

TO-92MOD Suggested Pad Layout

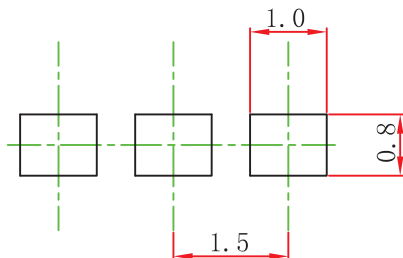

- Note:
1. Controlling dimension: in millimeters.
 2. General tolerance: ±0.05mm.
 3. The pad layout is for reference purposes only.

TO-92MOD PACKAGE TAPING DIMENSION

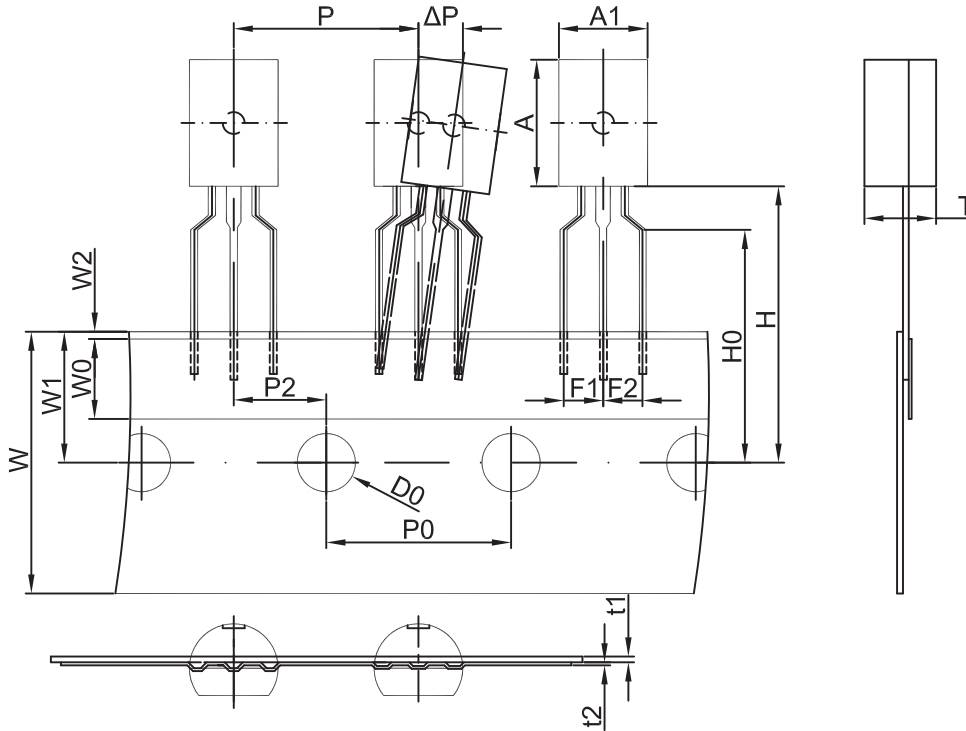

Dimensions are in millimeter

A1	A	T	P	P0	P2	F1	F2	W
6.0	8.6	4.9	12.7	12.7	6.35	2.5	2.5	18.0
W0	W1	W2	H	H0	D0	t1	t2	ΔP
6.0	9.0	1.0	19.0	16.0	4.0	0.4	0.2	0

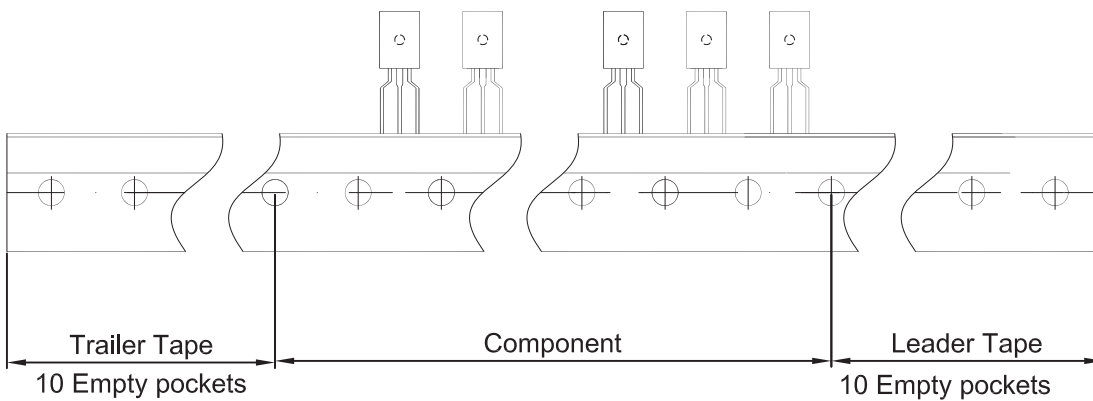

Package	Box	Box Size(mm)	Carton	Carton Size(mm)
TO-92MOD	2000 pcs	333×245×43	20,000 pcs	573×404×266