

Triacs

Silicon Bidirectional Thyristors

... designed primarily for full-wave ac control applications, such as light dimmers, motor controls, heating controls and power supplies.

- Blocking Voltage to 800 Volts
- Glass Passivated Junctions for Greater Parameter Uniformity and Stability
- TO-220 Construction Low Thermal Resistance, High Heat Dissipation and Durability
- Gate Triggering Guaranteed in Three Modes (MAC218 Series) or Four Modes (MAC218A Series)

**MAC218
Series
MAC218A
Series**

**TRIACs
8 AMPERES RMS
200 thru 800 VOLTS**

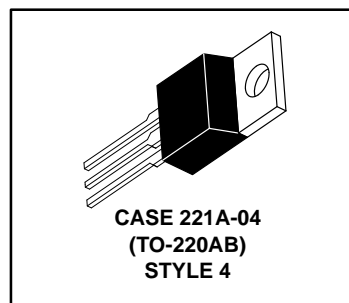
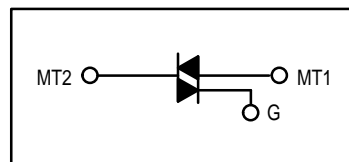

MAXIMUM RATINGS ($T_J = 25^\circ\text{C}$ unless otherwise noted.)

Rating	Symbol	Value	Unit
Peak Repetitive Off-State Voltage ⁽¹⁾ (Gate Open, $T_J = 25$ to 125°C)	V_{DRM}	200 400 600 800	Volts
On-State Current RMS (Conduction Angle = 360° , $T_C = +80^\circ\text{C}$)	$I_{\text{T(RMS)}}$	8	Amps
Peak Non-repetitive Surge Current (One Full Cycle, 60 Hz, $T_C = 80^\circ\text{C}$, preceded and followed by rated current)	I_{TSM}	100	Amps
Fusing Current ($t = 8.3$ ms)	I^2t	40	A^2s
Peak Gate Power ($T_C = +80^\circ\text{C}$, Pulse Width = $2 \mu\text{s}$)	P_{GM}	16	Watts
Average Gate Power ($T_C = +80^\circ\text{C}$, $t = 8.3$ ms)	$P_{\text{G(AV)}}$	0.35	Watt
Peak Gate Trigger Current (Pulse Width = $1 \mu\text{s}$)	I_{GTM}	4	Amps
Operating Junction Temperature Range	T_J	-40 to +125	$^\circ\text{C}$
Storage Temperature Range	T_{stg}	-40 to +150	$^\circ\text{C}$

1. V_{DRM} for all types can be applied on a continuous basis. Blocking voltages shall not be tested with a constant current source such that the voltage ratings of the devices are exceeded.

MAC218 Series MAC218A Series

THERMAL CHARACTERISTICS

Characteristic	Symbol	Max	Unit
Thermal Resistance, Junction to Case	$R_{\theta JC}$	2.2	$^{\circ}C/W$

ELECTRICAL CHARACTERISTICS ($T_C = 25^{\circ}C$ unless otherwise noted.)

Characteristic	Symbol	Min	Typ	Max	Unit
Peak Blocking Current ($V_D = \text{Rated } V_{DRM}$, gate open) $T_J = 25^{\circ}C$ $T_J = 125^{\circ}C$	I_{DRM}	— —	— —	10 2	μA mA
Peak On-State Voltage (Either Direction) ($I_{TM} = 11.3$ A Peak; Pulse Width = 1 to 2 ms, Duty Cycle < 2%)	V_{TM}	—	1.7	2	Volts
Gate Trigger Current (Continuous dc) ($V_D = 12$ Vdc, $R_L = 12\Omega$) Trigger Mode MT2(+), Gate(+); MT2(+), Gate(-); MT2(-), Gate(-) MT2(-), Gate(+) "A" SUFFIX ONLY	I_{GT}	— —	— —	50 75	mA
Gate Trigger Voltage (Continuous dc) (Main Terminal Voltage = 12 Vdc, $R_L = 100$ Ohms) MT2(+), G(+) MT2(+), G(-) MT2(-), G(-) MT2(-), G(+) "A" SUFFIX ONLY (Main Terminal Voltage = Rated V_{DRM} , $R_L = 10$ k Ω , $T_J = +125^{\circ}C$) MT2(+), G(+); MT2(-), G(-); MT2(+), G(-) MT2(-), G(+) "A" SUFFIX ONLY	V_{GT}	— — — — 0.2 0.2	0.9 0.9 1.1 1.4 — —	2 2 2 2.5 — —	Volts
Holding Current (Either Direction) ($V_D = 24$ Vdc, Gate Open, Initiating Current = 200 mA)	I_H	—	—	50	mA
Critical Rate of Rise of Commutating Off-State Voltage ($V_D = \text{Rated } V_{DRM}$, $I_{TM} = 11.3$ A, Commutating $di/dt = 4.1$ A/ms, Gate Unenergized, $T_C = 80^{\circ}C$)	$dv/dt(c)$	—	5	—	V/ μs
Critical Rate of Rise of Off-State Voltage ($V_D = \text{Rated } V_{DRM}$, Exponential Voltage Rise, Gate Open, $T_J = 125^{\circ}C$)	dv/dt	—	100	—	V/ μs

FIGURE 1 — CURRENT DERATING

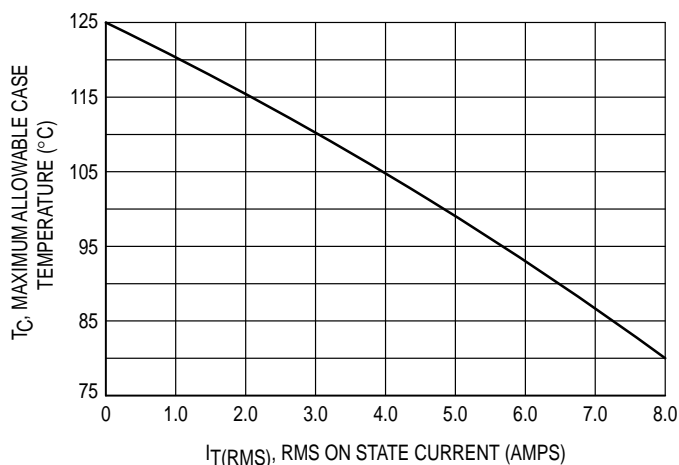

FIGURE 2 — POWER DISSIPATION

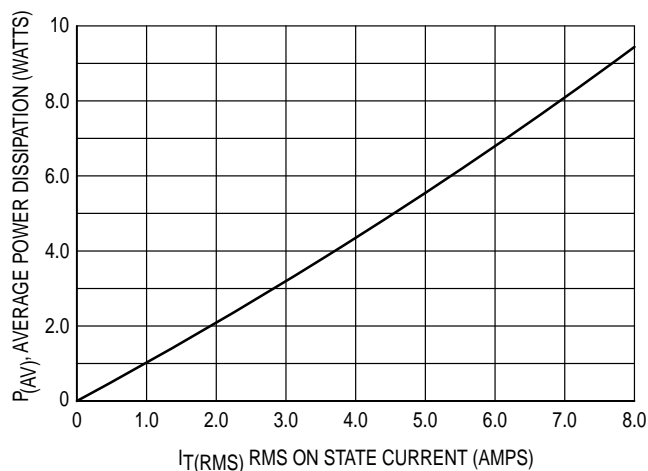

FIGURE 3 — NORMALIZED GATE TRIGGER CURRENT

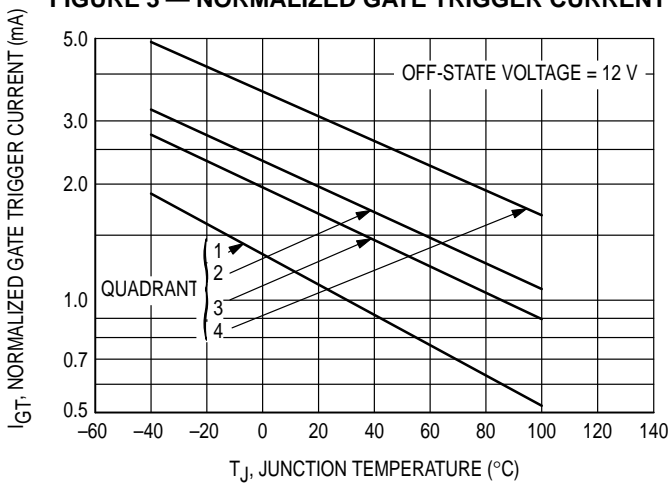

FIGURE 4 — NORMALIZED GATE TRIGGER VOLTAGE

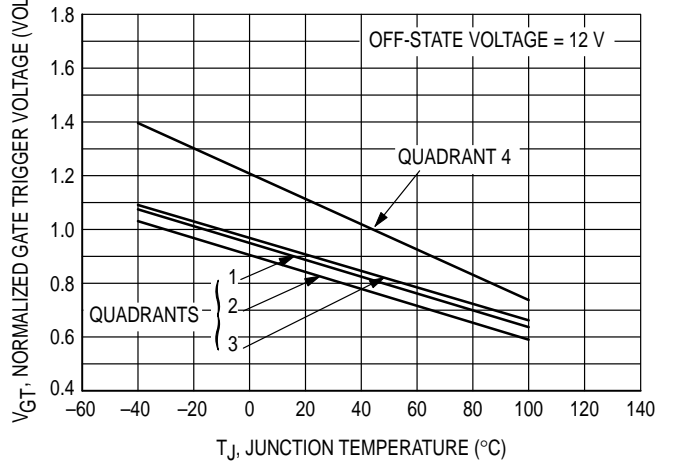
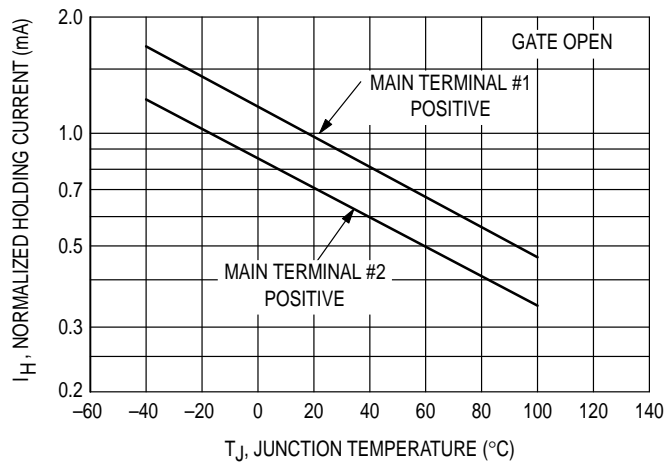
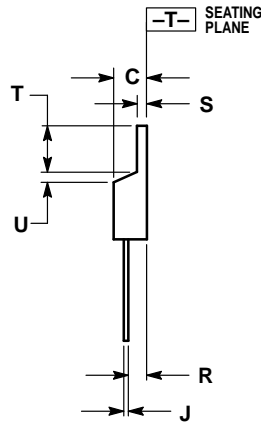
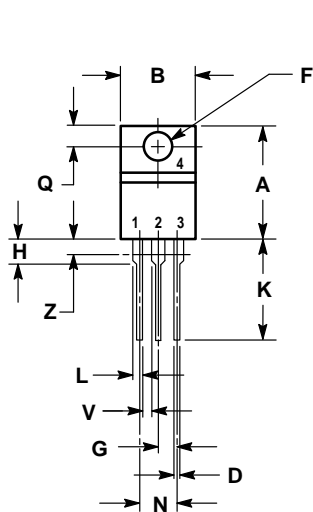

FIGURE 5 — NORMALIZED HOLDING CURRENT



PACKAGE DIMENSIONS



STYLE 4:
 PIN 1. MAIN TERMINAL 1
 2. MAIN TERMINAL 2
 3. GATE
 4. MAIN TERMINAL 2

- NOTES:
 1. DIMENSIONING AND TOLERANCING PER ANSI Y14.5M, 1982.
 2. CONTROLLING DIMENSION: INCH.
 3. DIMENSION Z DEFINES A ZONE WHERE ALL BODY AND LEAD IRREGULARITIES ARE ALLOWED.

DIM	INCHES		MILLIMETERS	
	MIN	MAX	MIN	MAX
A	0.570	0.620	14.48	15.75
B	0.380	0.405	9.66	10.28
C	0.160	0.190	4.07	4.82
D	0.025	0.035	0.64	0.88
F	0.142	0.147	3.61	3.73
G	0.095	0.105	2.42	2.66
H	0.110	0.155	2.80	3.93
J	0.014	0.022	0.36	0.55
K	0.500	0.562	12.70	14.27
L	0.045	0.055	1.15	1.39
N	0.190	0.210	4.83	5.33
Q	0.100	0.120	2.54	3.04
R	0.080	0.110	2.04	2.79
S	0.045	0.055	1.15	1.39
T	0.235	0.255	5.97	6.47
U	0.000	0.050	0.00	1.27
V	0.045	—	1.15	—
Z	—	0.080	—	2.04

CASE 221A-04
(TO-220AB)

Motorola reserves the right to make changes without further notice to any products herein. Motorola makes no warranty, representation or guarantee regarding the suitability of its products for any particular purpose, nor does Motorola assume any liability arising out of the application or use of any product or circuit, and specifically disclaims any and all liability, including without limitation consequential or incidental damages. "Typical" parameters can and do vary in different applications. All operating parameters, including "Typicals" must be validated for each customer application by customer's technical experts. Motorola does not convey any license under its patent rights nor the rights of others. Motorola products are not designed, intended, or authorized for use as components in systems intended for surgical implant into the body, or other applications intended to support or sustain life, or for any other application in which the failure of the Motorola product could create a situation where personal injury or death may occur. Should Buyer purchase or use Motorola products for any such unintended or unauthorized application, Buyer shall indemnify and hold Motorola and its officers, employees, subsidiaries, affiliates, and distributors harmless against all claims, costs, damages, and expenses, and reasonable attorney fees arising out of, directly or indirectly, any claim of personal injury or death associated with such unintended or unauthorized use, even if such claim alleges that Motorola was negligent regarding the design or manufacture of the part. Motorola and are registered trademarks of Motorola, Inc. Motorola, Inc. is an Equal Opportunity/Affirmative Action Employer.

Literature Distribution Centers:

USA: Motorola Literature Distribution; P.O. Box 20912; Phoenix, Arizona 85036.
 EUROPE: Motorola Ltd.; European Literature Centre; 88 Tanners Drive, Blakelands, Milton Keynes, MK14 5BP, England.
 JAPAN: Nippon Motorola Ltd.; 4-32-1, Nishi-Gotanda, Shinagawa-ku, Tokyo 141, Japan.
 ASIA PACIFIC: Motorola Semiconductors H.K. Ltd.; Silicon Harbour Center, No. 2 Dai King Street, Tai Po Industrial Estate, Tai Po, N.T., Hong Kong.

