

IRG4BC20KDPbF

INSULATED GATE BIPOLAR TRANSISTOR WITH
ULTRAFAST SOFT RECOVERY DIODE

Short Circuit Rated
UltraFast IGBT

Features

- Short Circuit Rated UltraFast: Optimized for high operating frequencies >5.0 kHz, and Short Circuit Rated to 10 μ s @ 125°C, $V_{GE} = 15V$
- Generation 4 IGBT design provides tighter parameter distribution and higher efficiency than previous generation
- IGBT co-packaged with HEXFRED™ ultrafast, ultra-soft-recovery anti-parallel diodes for use in bridge configurations
- Industry standard TO-220AB package
- Lead-Free

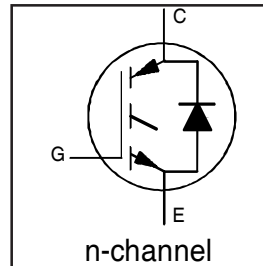

$V_{CES} = 600V$
$V_{CE(on)} \text{ typ.} = 2.27V$
@ $V_{GE} = 15V, I_C = 9.0A$

Benefits

- Latest generation 4 IGBTs offer highest power density motor controls possible
- HEXFRED™ diodes optimized for performance with IGBTs. Minimized recovery characteristics reduce noise, EMI and switching losses
- This part replaces the IRGBC20KD2 and IRGBC20MD2 products
- For hints see design tip 97003

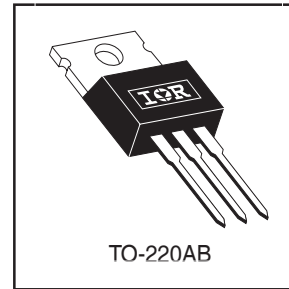

Absolute Maximum Ratings

	Parameter	Max.	Units
V_{CES}	Collector-to-Emitter Voltage	600	V
$I_C @ T_C = 25^\circ C$	Continuous Collector Current	16	A
$I_C @ T_C = 100^\circ C$	Continuous Collector Current	9.0	
I_{CM}	Pulsed Collector Current ①	32	
I_{LM}	Clamped Inductive Load Current ②	32	
$I_F @ T_C = 100^\circ C$	Diode Continuous Forward Current	7.0	
I_{FM}	Diode Maximum Forward Current	32	
t_{sc}	Short Circuit Withstand Time	10	μ s
V_{GE}	Gate-to-Emitter Voltage	± 20	V
$P_D @ T_C = 25^\circ C$	Maximum Power Dissipation	60	W
$P_D @ T_C = 100^\circ C$	Maximum Power Dissipation	24	
T_J	Operating Junction and Storage Temperature Range	-55 to +150	$^\circ C$
T_{STG}			
	Mounting Torque, 6-32 or M3 Screw.	10 lbf•in (1.1 N•m)	

Thermal Resistance

	Parameter	Min.	Typ.	Max.	Units
$R_{\theta JC}$	Junction-to-Case - IGBT	---	---	2.1	$^\circ C/W$
$R_{\theta JC}$	Junction-to-Case - Diode	---	---	3.5	
$R_{\theta CS}$	Case-to-Sink, flat, greased surface	---	0.50	---	
$R_{\theta JA}$	Junction-to-Ambient, typical socket mount	---	---	80	
Wt	Weight	---	2 (0.07)	---	g (oz)

IRG4BC20KDPbF

Electrical Characteristics @ $T_J = 25^\circ\text{C}$ (unless otherwise specified)

	Parameter	Min.	Typ.	Max.	Units	Conditions
$V_{(BR)CES}$	Collector-to-Emitter Breakdown Voltage ^③	600	—	—	V	$V_{GE} = 0V, I_C = 250\mu A$
$\Delta V_{(BR)CES}/\Delta T_J$	Temperature Coeff. of Breakdown Voltage	—	0.49	—	V/ $^\circ\text{C}$	$V_{GE} = 0V, I_C = 1.0mA$
$V_{CE(on)}$	Collector-to-Emitter Saturation Voltage	—	2.27	2.8	V	$I_C = 9.0A$ $V_{GE} = 15V$
		—	3.01	—		$I_C = 16A$ See Fig. 2, 5
		—	2.43	—		$I_C = 9.0A, T_J = 150^\circ\text{C}$
$V_{GE(th)}$	Gate Threshold Voltage	3.0	—	6.0		$V_{CE} = V_{GE}, I_C = 250\mu A$
$\Delta V_{GE(th)}/\Delta T_J$	Temperature Coeff. of Threshold Voltage	—	-10	—	mV/ $^\circ\text{C}$	$V_{CE} = V_{GE}, I_C = 250\mu A$
g_{fe}	Forward Transconductance ^④	2.9	4.3	—	S	$V_{CE} = 100V, I_C = 9.0A$
I_{CES}	Zero Gate Voltage Collector Current	—	—	250	μA	$V_{GE} = 0V, V_{CE} = 600V$
		—	—	1000		$V_{GE} = 0V, V_{CE} = 600V, T_J = 150^\circ\text{C}$
V_{FM}	Diode Forward Voltage Drop	—	1.4	1.7	V	$I_C = 8.0A$ See Fig. 13
		—	1.3	1.6		$I_C = 8.0A, T_J = 150^\circ\text{C}$
I_{GES}	Gate-to-Emitter Leakage Current	—	—	± 100	nA	$V_{GE} = \pm 20V$

Switching Characteristics @ $T_J = 25^\circ\text{C}$ (unless otherwise specified)

	Parameter	Min.	Typ.	Max.	Units	Conditions
Q_g	Total Gate Charge (turn-on)	—	34	51	nC	$I_C = 9.0A$ $V_{CC} = 400V$ See Fig. 8 $V_{GE} = 15V$
Q_{ge}	Gate - Emitter Charge (turn-on)	—	4.9	7.4		
Q_{gc}	Gate - Collector Charge (turn-on)	—	14	21		
$t_{d(on)}$	Turn-On Delay Time	—	54	—	ns	$T_J = 25^\circ\text{C}$ $I_C = 9.0A, V_{CC} = 480V$ $V_{GE} = 15V, R_G = 50\Omega$
t_r	Rise Time	—	34	—		
$t_{d(off)}$	Turn-Off Delay Time	—	180	270		
t_f	Fall Time	—	72	110		
E_{on}	Turn-On Switching Loss	—	0.34	—	mJ	Energy losses include "tail" and diode reverse recovery See Fig. 9,10,14
E_{off}	Turn-Off Switching Loss	—	0.30	—		
E_{ts}	Total Switching Loss	—	0.64	0.96		
t_{sc}	Short Circuit Withstand Time	10	—	—	μs	$V_{CC} = 360V, T_J = 125^\circ\text{C}$ $V_{GE} = 15V, R_G = 50\Omega, V_{CPK} < 500V$
$t_{d(on)}$	Turn-On Delay Time	—	51	—	ns	$T_J = 150^\circ\text{C}$, See Fig. 11,14 $I_C = 9.0A, V_{CC} = 480V$ $V_{GE} = 15V, R_G = 50\Omega$
t_r	Rise Time	—	37	—		
$t_{d(off)}$	Turn-Off Delay Time	—	220	—		
t_f	Fall Time	—	160	—		
E_{ts}	Total Switching Loss	—	0.85	—	mJ	Energy losses include "tail" and diode reverse recovery
L_E	Internal Emitter Inductance	—	7.5	—	nH	Measured 5mm from package
C_{ies}	Input Capacitance	—	450	—	pF	$V_{GE} = 0V$ $V_{CC} = 30V$ See Fig. 7 $f = 1.0MHz$
C_{oes}	Output Capacitance	—	61	—		
C_{res}	Reverse Transfer Capacitance	—	14	—		
t_{rr}	Diode Reverse Recovery Time	—	37	55	ns	$T_J = 25^\circ\text{C}$ See Fig. 14
		—	55	90		$T_J = 125^\circ\text{C}$
I_{rr}	Diode Peak Reverse Recovery Current	—	3.5	5.0	A	$T_J = 25^\circ\text{C}$ See Fig. 15
		—	4.5	8.0		$T_J = 125^\circ\text{C}$
Q_{rr}	Diode Reverse Recovery Charge	—	65	138	nC	$T_J = 25^\circ\text{C}$ See Fig. 16
		—	124	360		$T_J = 125^\circ\text{C}$
$di_{(rec)M}/dt$	Diode Peak Rate of Fall of Recovery During t_b	—	240	—	A/ μs	$T_J = 25^\circ\text{C}$ See Fig. 17
		—	210	—		$T_J = 125^\circ\text{C}$

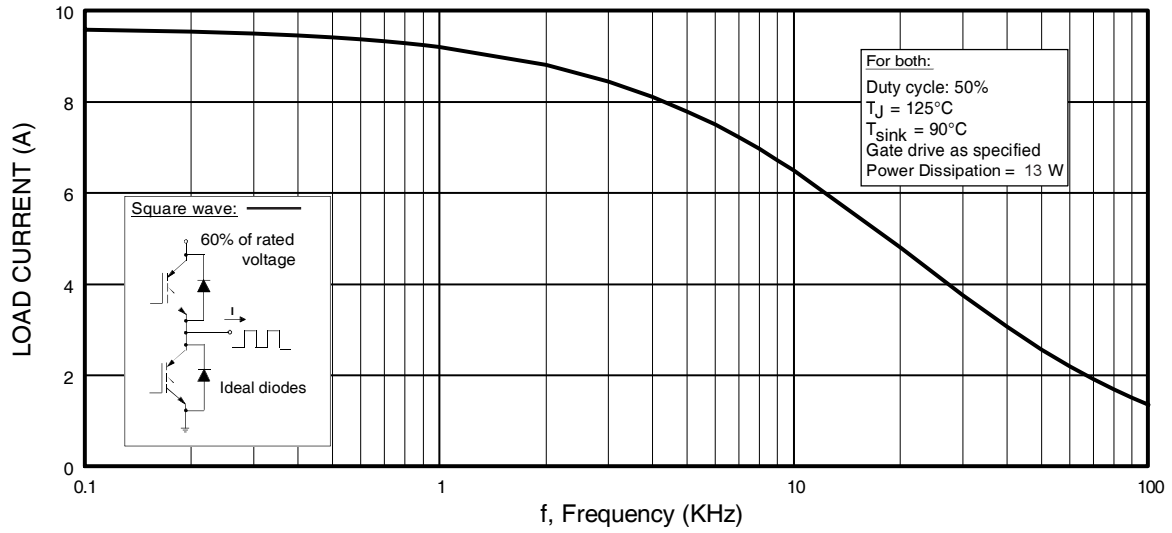

Fig. 1 - Typical Load Current vs. Frequency
 (Load Current = I_{RMS} of fundamental)

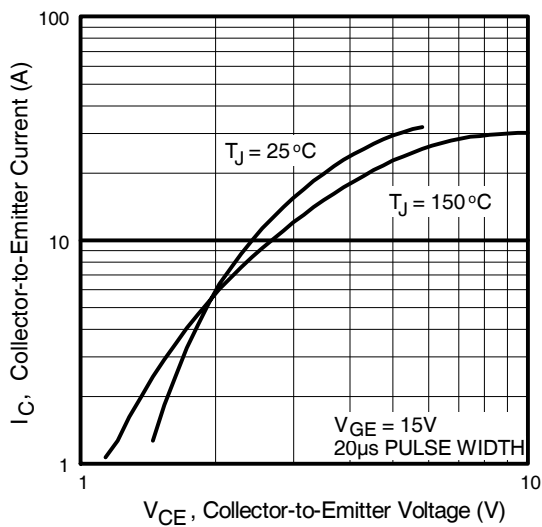

Fig. 2 - Typical Output Characteristics

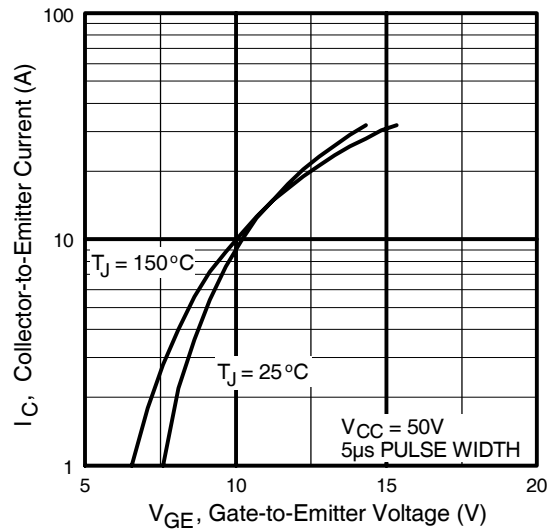

Fig. 3 - Typical Transfer Characteristics

IRG4BC20KDPbF

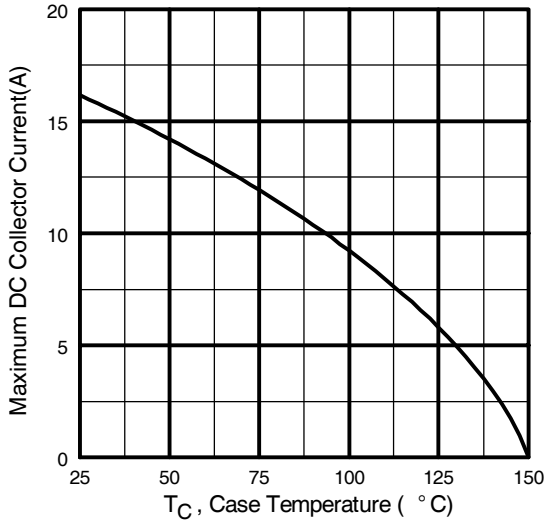

Fig. 4 - Maximum Collector Current vs. Case Temperature

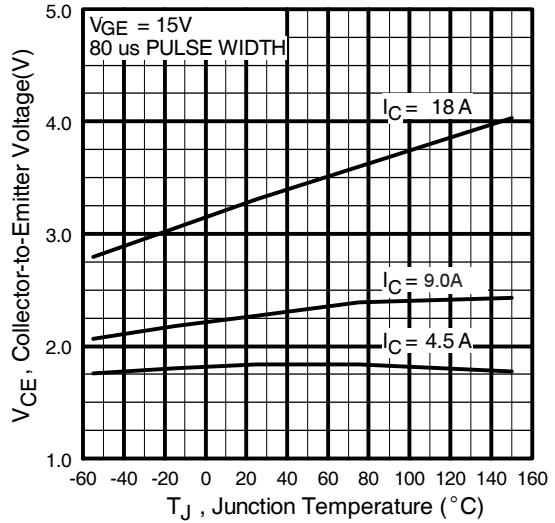

Fig. 5 - Typical Collector-to-Emitter Voltage vs. Junction Temperature

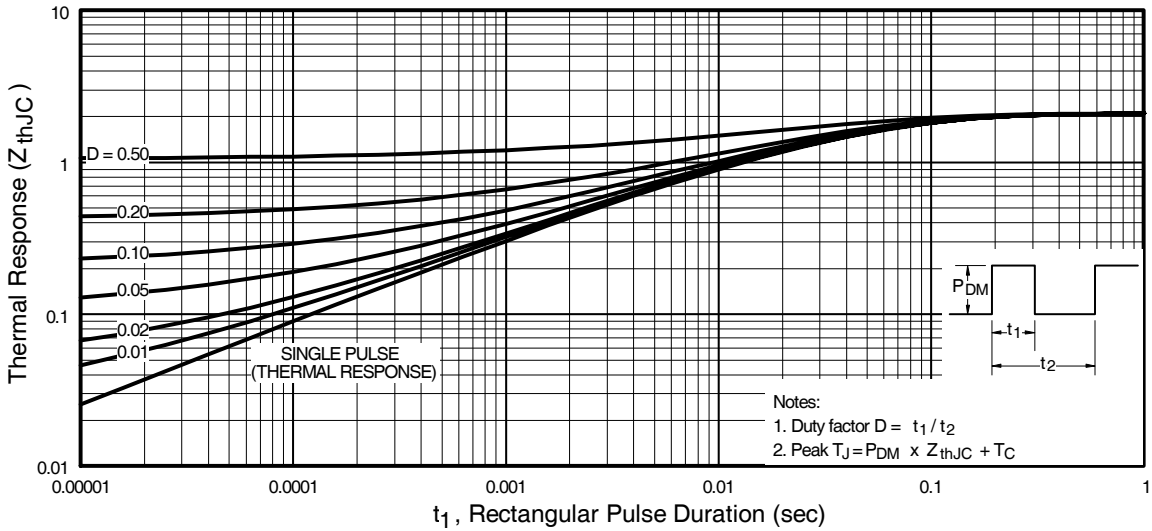

Fig. 6 - Maximum Effective Transient Thermal Impedance, Junction-to-Case

IRG4BC20KDPbF

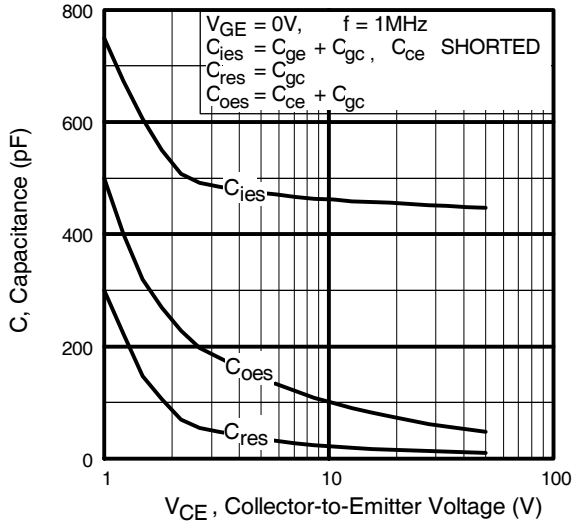

Fig. 7 - Typical Capacitance vs. Collector-to-Emitter Voltage

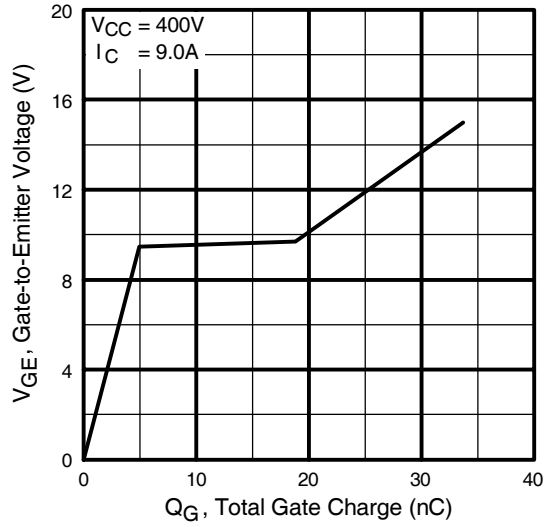

Fig. 8 - Typical Gate Charge vs. Gate-to-Emitter Voltage

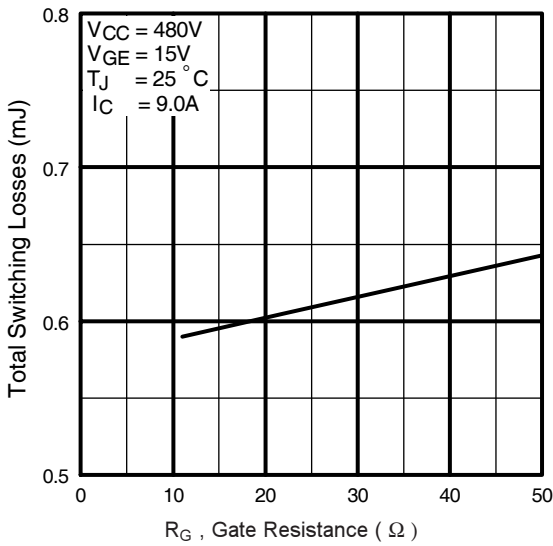

Fig. 9 - Typical Switching Losses vs. Gate Resistance

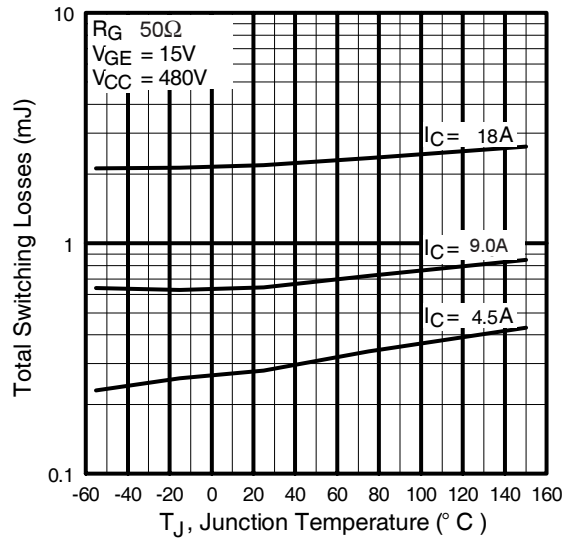

Fig. 10 - Typical Switching Losses vs. Junction Temperature

IRG4BC20KDPbF

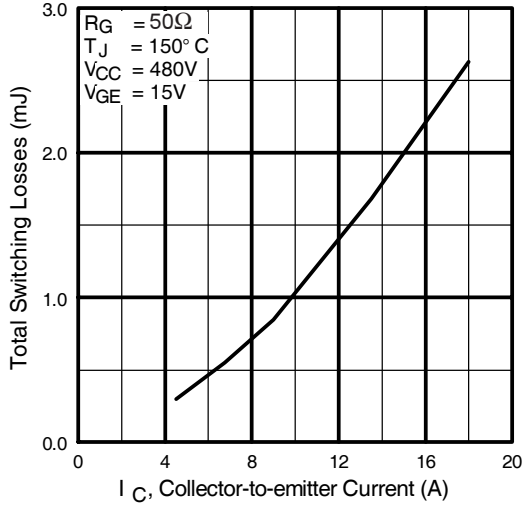

Fig. 11 - Typical Switching Losses vs. Collector-to-Emitter Current

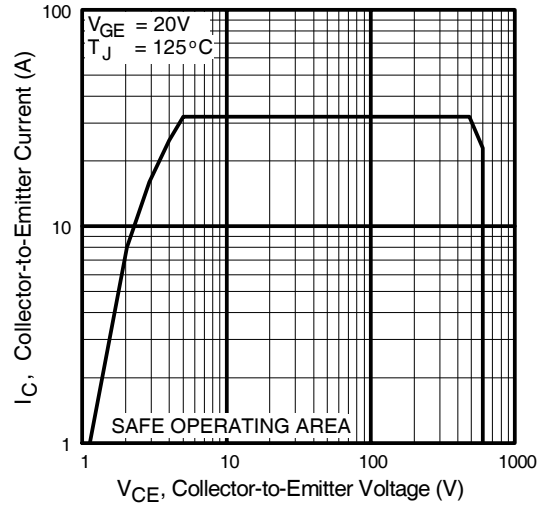

Fig. 12 - Turn-Off SOA

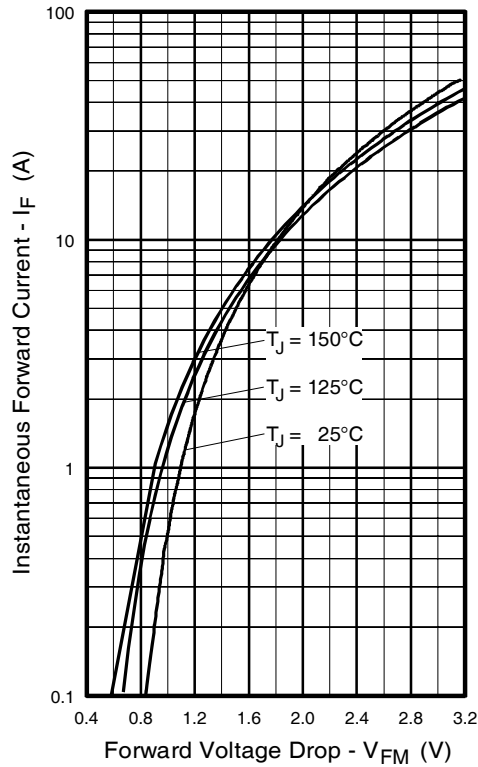

Fig. 13 - Maximum Forward Voltage Drop vs. Instantaneous Forward Current

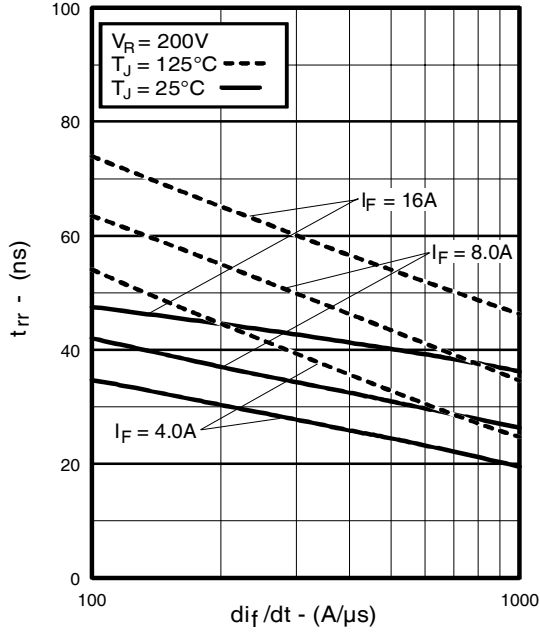

Fig. 14 - Typical Reverse Recovery vs. di_f/dt

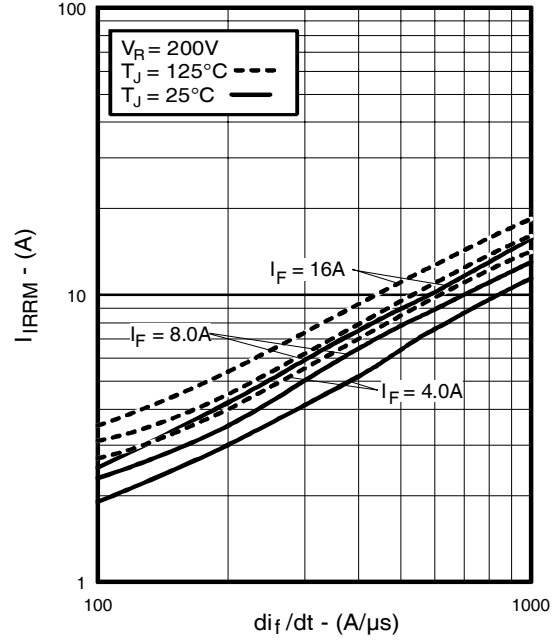

Fig. 15 - Typical Recovery Current vs. di_f/dt

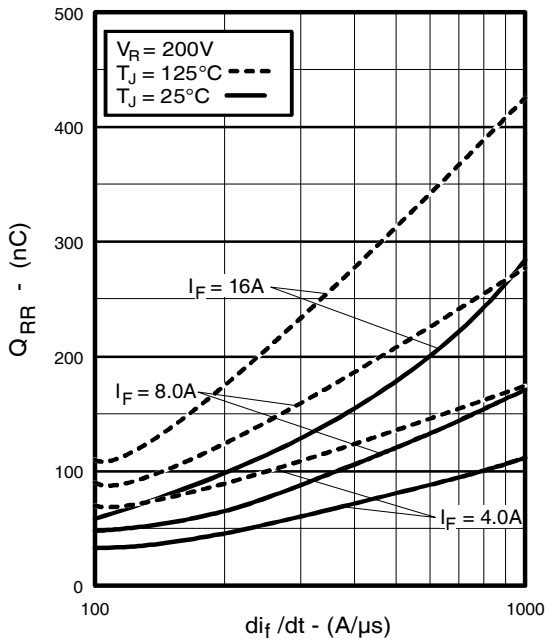

Fig. 16 - Typical Stored Charge vs. di_f/dt

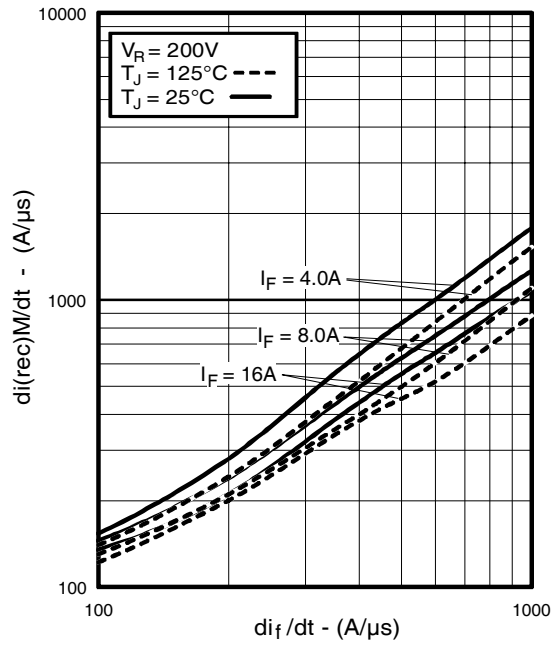

Fig. 17 - Typical $di(\text{rec})M/dt$ vs. di_f/dt

IRG4BC20KDPbF

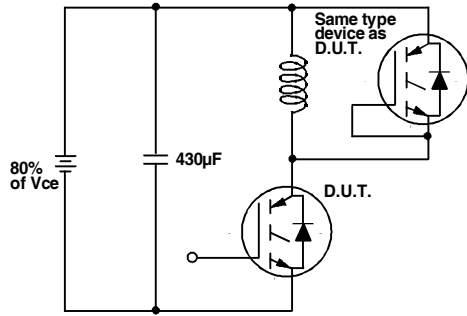

Fig. 18a - Test Circuit for Measurement of I_{LM} , E_{on} , $E_{off}(\text{diode})$, t_{rr} , Q_{rr} , I_{rr} , $t_{d(on)}$, t_r , $t_{d(off)}$, t_f

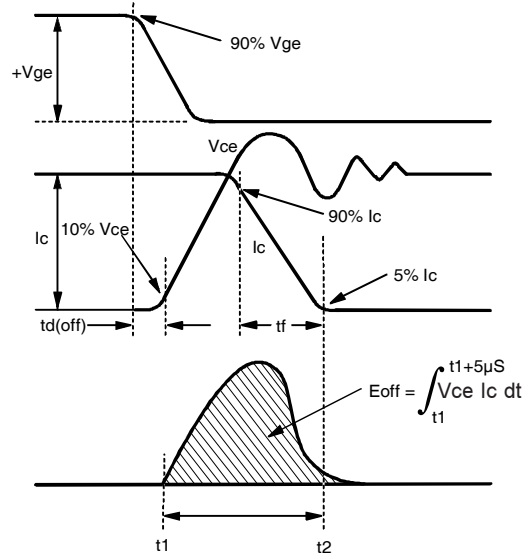

Fig. 18b - Test Waveforms for Circuit of Fig. 18a, Defining E_{off} , $t_{d(off)}$, t_f

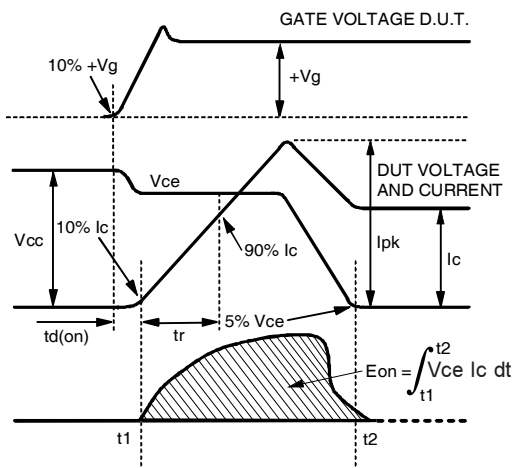

Fig. 18c - Test Waveforms for Circuit of Fig. 18a, Defining E_{on} , $t_{d(on)}$, t_r

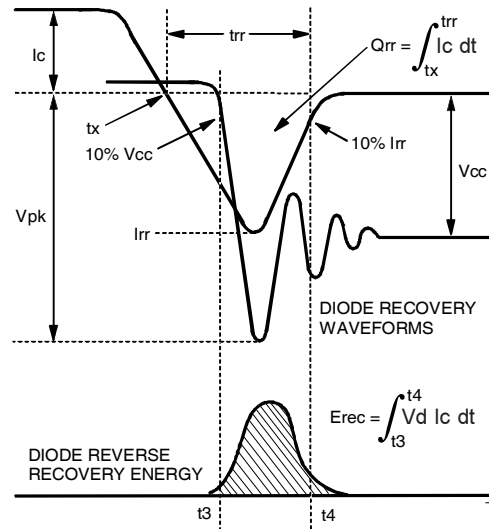

Fig. 18d - Test Waveforms for Circuit of Fig. 18a, Defining E_{rec} , t_{rr} , Q_{rr} , I_{rr}

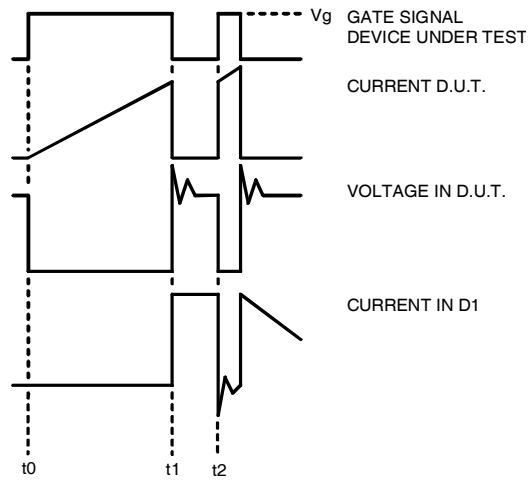

Figure 18e. Macro Waveforms for Figure 18a's Test Circuit



Figure 19. Clamped Inductive Load Test Circuit

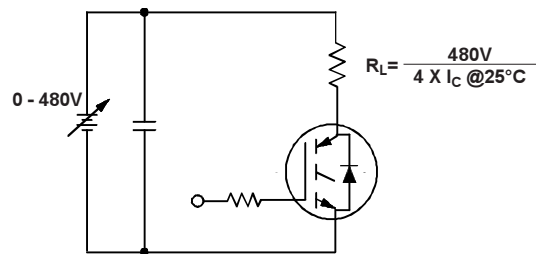

Figure 20. Pulsed Collector Current Test Circuit

IRG4BC20KDPbF

Notes:

- ① Repetitive rating: $V_{GE}=20V$; pulse width limited by maximum junction temperature (figure 20)
- ② $V_{CC}=80\%(V_{CES})$, $V_{GE}=20V$, $L=10\mu H$, $R_G=50\Omega$ (figure 19)
- ③ Pulse width $\leq 80\mu s$; duty factor $\leq 0.1\%$.
- ④ Pulse width $5.0\mu s$, single shot.

TO-220AB Package Outline

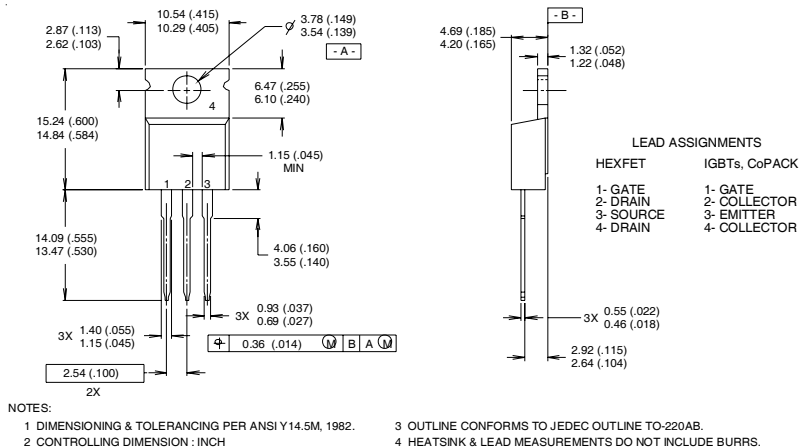

TO-220AB Part Marking Information

EXAMPLE: THIS IS AN IRF1010
 LOT CODE 1789
 ASSEMBLED ON WW 19, 1997
 IN THE ASSEMBLY LINE "C"
Note: "P" in assembly line
 position indicates "Lead-Free"

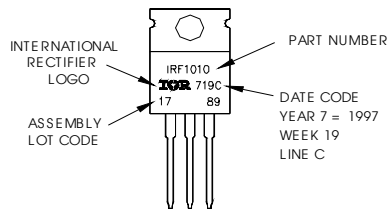

Data and specifications subject to change without notice.

Note: For the most current drawings please refer to the IR website at:
<http://www.irf.com/package/>