

SBD Type : EC10QS10

FEATURES

- * Miniature Size, Surface Mount Device
- * Low Forward Voltage Drop
- * Low Power Loss, High Efficiency
- * High Surge Capability
- * 30 Volts through 100Volts Types Available
- * Packaged in 12mm Tape and Reel
- * Not Rolling During Assembly

OUTLINE DRAWING

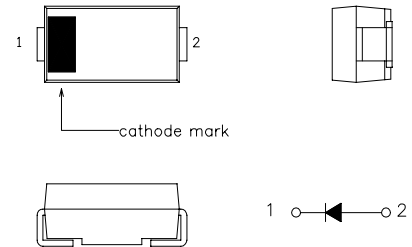

Maximum Ratings

Approx Net Weight:0.06g

Rating	Symbol	EC10QS10		Unit
Repetitive Peak Reverse Voltage	V_{RRM}	100		V
Average Rectified Output Current	I_O	0.89	$T_a=25\text{ }^\circ\text{C}$ *1	50Hz Half Sine Wave Resistive Load
		1.0	$T_a=52\text{ }^\circ\text{C}$ *2	
RMS Forward Current	$I_{F(RMS)}$	1.57		A
Surge Forward Current	I_{FSM}	20	50Hz Half Sine Wave, 1cycle Non-repetitive	A
Operating Junction Temperature Range	T_{jw}	-40 to +150		$^\circ\text{C}$
Storage Temperature Range	T_{stg}	-40 to +150		$^\circ\text{C}$

Electrical • Thermal Characteristics

Characteristics	Symbol	Conditions	Min.	Typ.	Max.	Unit	
Peak Reverse Current	I_{RM}	$T_j= 25^\circ\text{C}$, $V_{RM}= V_{RRM}$	-	-	0.5	mA	
Peak Forward Voltage	V_{FM}	$T_j= 25^\circ\text{C}$, $I_{FM}= 1.0\text{A}$	-	-	0.85	V	
Thermal Resistance	$R_{th(j-a)}$	Junction to Ambient	*1	-	-	157	$^\circ\text{C}/\text{W}$
			*2	-	-	108	

*1 Glass Epoxy Substrate Mounted

*2 Alumina Substrate Mounted

Soldering Lands=2x2mm, Both Sides

EC10QS10 OUTLINE DRAWING (Dimensions in mm)

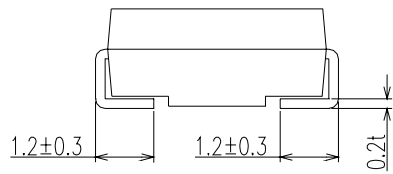
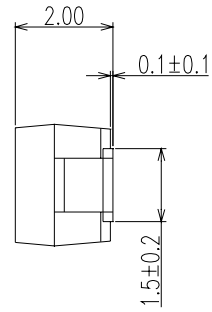
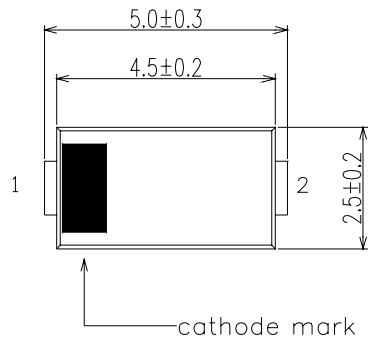

SOLDERING PAD

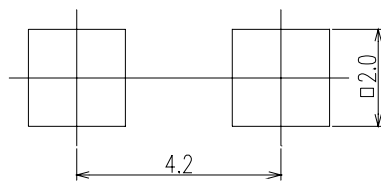

FORWARD CURRENT VS. VOLTAGE

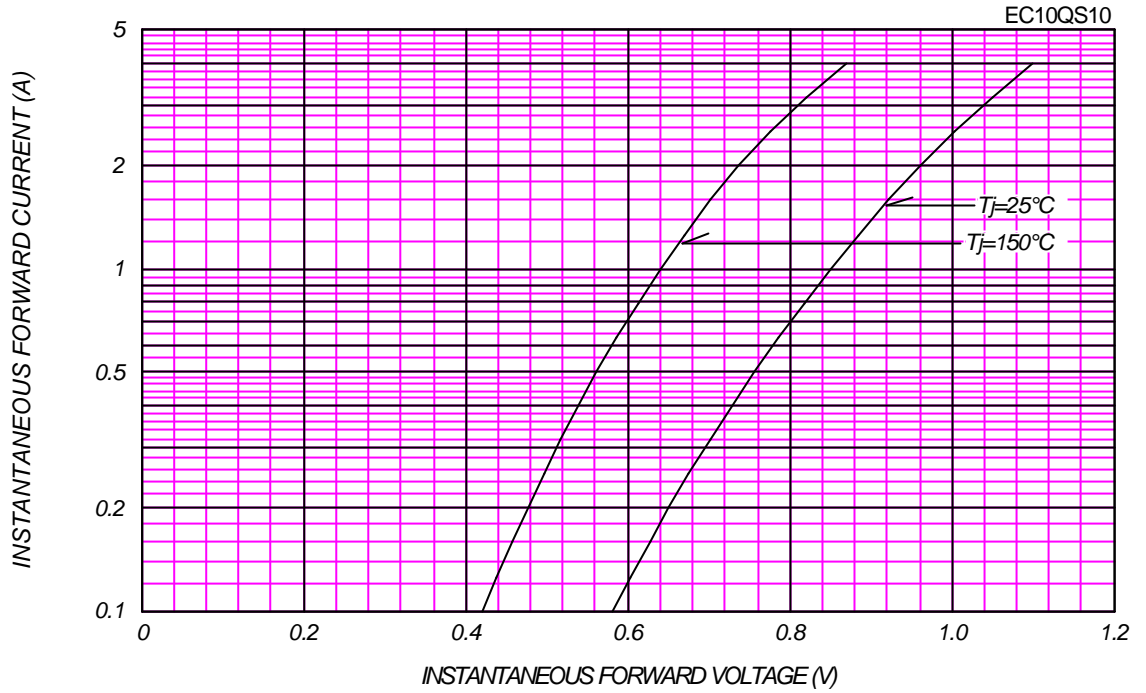

AVERAGE FORWARD POWER DISSIPATION

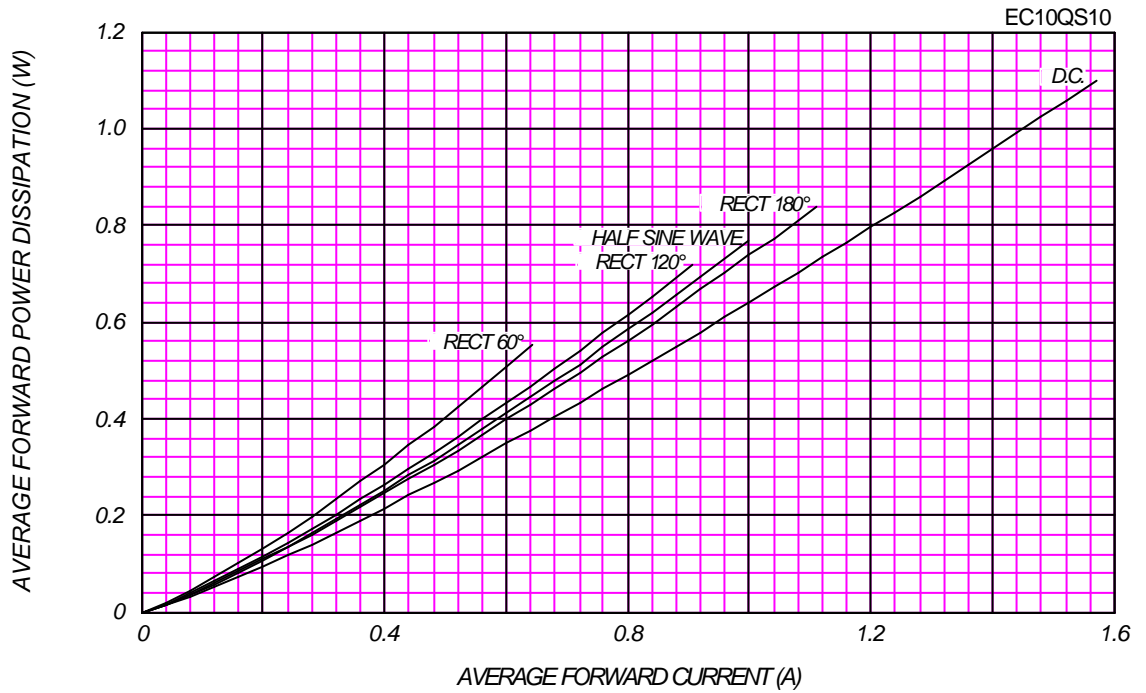

PEAK REVERSE CURRENT VS. PEAK REVERSE VOLTAGE

$T_j = 150^\circ\text{C}$

EC10QS10

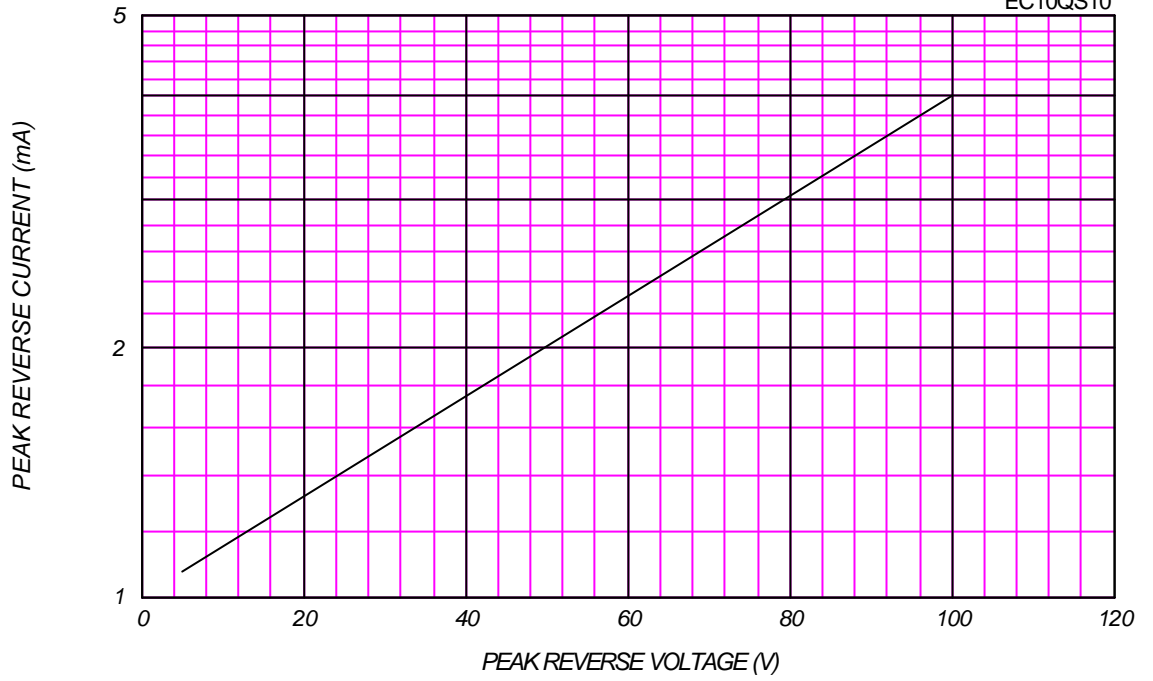

AVERAGE REVERSE POWER DISSIPATION

EC10QS10

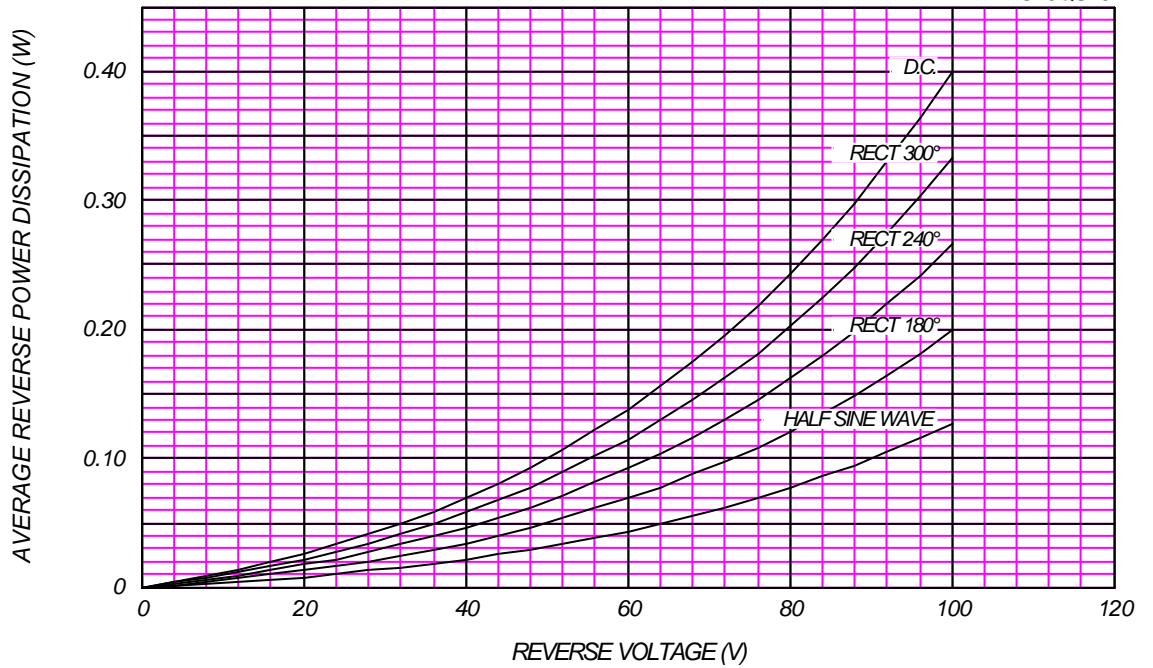



AVERAGE FORWARD CURRENT VS. AMBIENT TEMPERATURE

Alumina Substrate Mounted (Land=2x2mm), $V_{RM}=100V$

EC10QS10

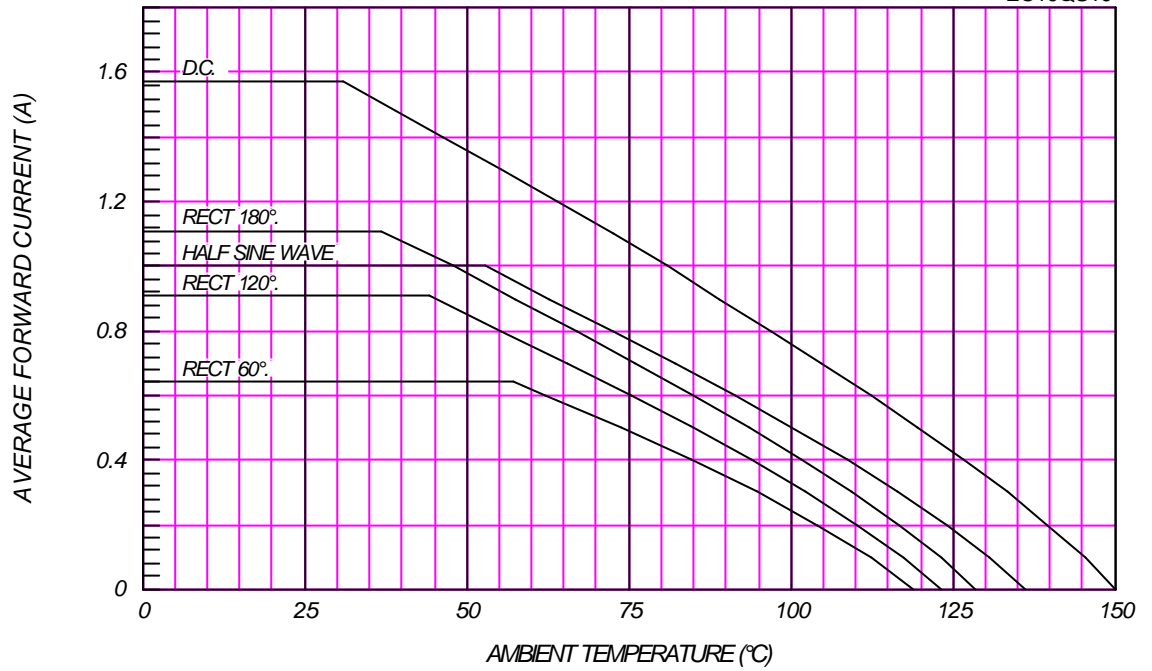

AVERAGE FORWARD CURRENT VS. LEAD TEMPERATURE

$V_{RM}=100V$

EC10QS10

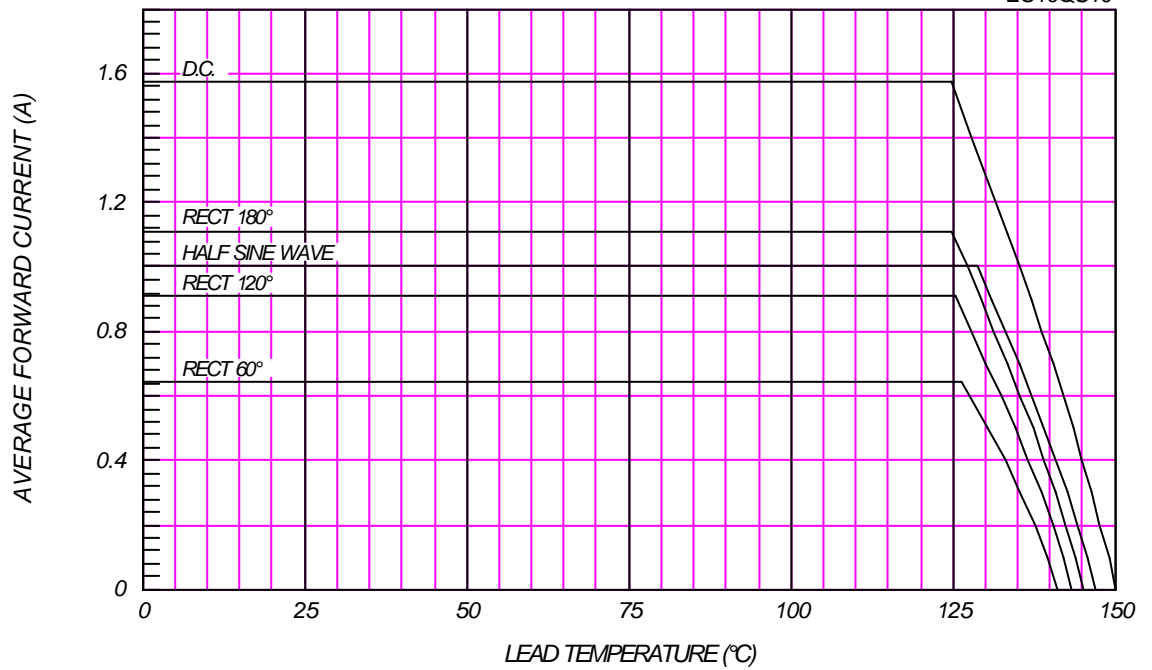

SURGE CURRENT RATINGS

f=50Hz, Half Sine Wave, Non-Repetitive, No Load

EC10QS10

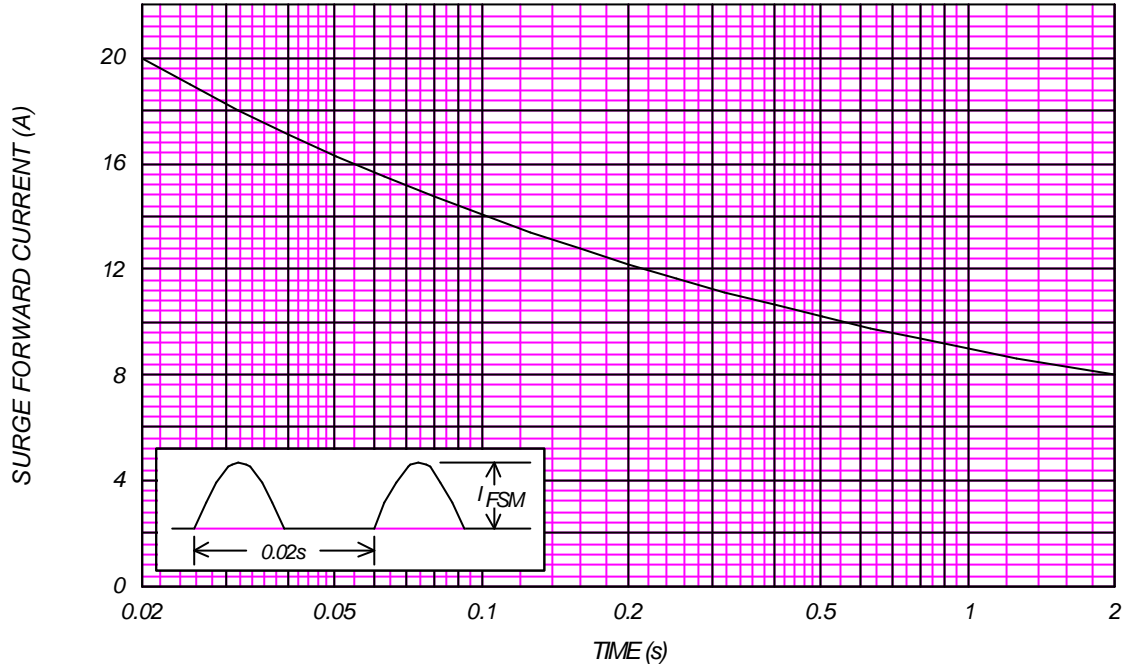

JUNCTION CAPACITANCE VS. REVERSE VOLTAGE

$T_j=25^\circ\text{C}$, $V_m=20\text{mV}_{RMS}$, $f=100\text{kHz}$, Typical Value

EC10QS10

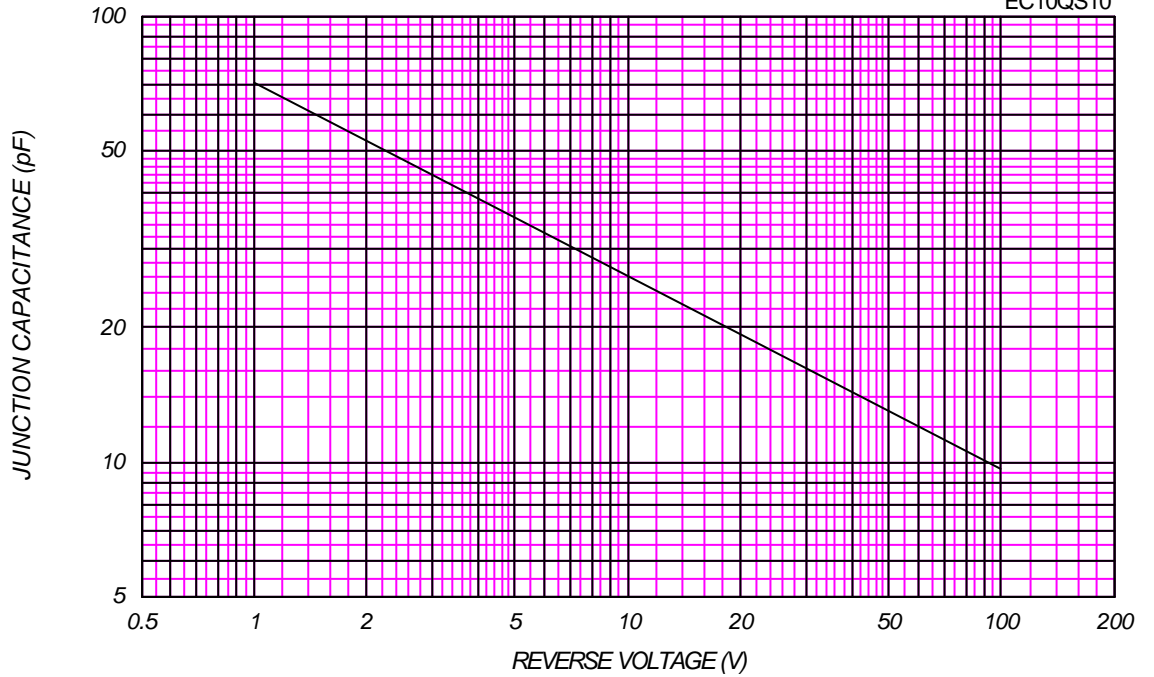

This datasheet has been downloaded from:

www.DatasheetCatalog.com

Datasheets for electronic components.