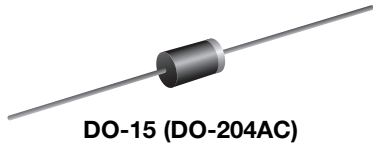


TRANSZORB® Transient Voltage Suppressors



PRIMARY CHARACTERISTICS	
V_{WM}	5.0 V to 170 V
V_{BR} (uni-directional)	6.4 V to 209 V
V_{BR} (bi-directional)	6.4 V to 209 V
P_{PPM}	500 W
P_D	3.0 W
I_{FSM} (uni-directional only)	70 A
T_J max.	175 °C
Polarity	Uni-directional, bi-directional
Package	DO-15 (DO-204AC)

DEVICES FOR BI-DIRECTION APPLICATIONS

For bi-directional types, use CA suffix (e.g. SA5.0CA, SA170CA).

Electrical characteristics apply in both directions.

FEATURES

- Glass passivated chip junction
- Available in uni-directional and bi-directional
- 500 W peak pulse power capability with a 10/1000 μ s waveform, repetitive rate (duty cycle): 0.01 %
- Excellent clamping capability
- Very fast response time
- Low incremental surge resistance
- Solder dip 275 °C max. 10 s, per JESD 22-B106
- AEC-Q101 qualified
- Material categorization: for definitions of compliance please see www.vishay.com/doc?99912



RoHS
COMPLIANT

TYPICAL APPLICATIONS

Use in sensitive electronics protection against voltage transients induced by inductive load switching and lighting on ICs, MOSFET, signal lines of sensor units for consumer, computer, industrial, and telecommunication.

MECHANICAL DATA

Case: DO-15 (DO-204AC)

Molded epoxy over passivated chip

Molding compound meets UL 94 V-0 flammability rating
Base P/N-E3 - RoHS compliant, commercial grade
Base P/NHE3 - RoHS compliant, AEC-Q101 qualified

Terminals: matte tin plated leads, solderable per J-STD-002 and JESD 22-B102

E3 suffix meets JESD 201 class 1A whisker test, HE3 suffix meets JESD 201 class 2 whisker test

Polarity: for uni-directional types the color band denotes cathode end, no marking on bi-directional types

MAXIMUM RATINGS ($T_A = 25$ °C unless otherwise noted)			
PARAMETER	SYMBOL	VALUE	UNIT
Peak pulse power dissipation with a 10/1000 μ s waveform ⁽¹⁾ (fig. 1)	P_{PPM}	500	W
Peak pulse current with a 10/1000 μ s waveform ⁽¹⁾	I_{PPM}	See next table	A
Power dissipation on infinite heatsink at $T_L = 75$ °C (fig. 5)	P_D	3.0	W
Peak forward surge current 10 ms single half sine-wave uni-directional only	I_{FSM}	70	A
Maximum instantaneous forward voltage at 100 A for uni-directional only ⁽³⁾	V_F	3.5	V
Operating junction and storage temperature range	T_J, T_{STG}	-55 to +175	°C

Notes

⁽¹⁾ Non-repetitive current pulse, per fig. 3 and derated above $T_A = 25$ °C per fig. 2

⁽²⁾ 8.3 ms single half sine-wave or equivalent square wave, duty cycle = 4 pulses per minute maximum



ELECTRICAL CHARACTERISTICS ($T_A = 25\text{ }^\circ\text{C}$ unless otherwise noted)								
DEVICE TYPE	BREAKDOWN VOLTAGE V_{BR} AT I_T ⁽¹⁾ (V)		TEST CURRENT I_T (mA)	STAND-OFF VOLTAGE V_{WM} (V)	MAXIMUM REVERSE LEAKAGE AT V_{WM} ⁽³⁾ I_D (μA)	MAXIMUM PEAK PULSE CURRENT I_{PPM} ⁽²⁾ (A)	MAXIMUM CLAMPING VOLTAGE AT I_{PPM} V_C (V)	MAXIMUM TEMPERATURE COEFFICIENT AT V_{BR} (mV/ $^\circ\text{C}$)
	MIN.	MAX.						
SA5.0A ⁽⁴⁾	6.40	7.07	10	5.0	600	54.3	9.2	5
SA6.0A	6.67	7.37	10	6.0	600	48.5	10.3	5
SA6.5A	7.22	7.98	10	6.5	400	44.7	11.2	5
SA7.0A	7.78	8.60	10	7.0	150	41.7	12.0	6
SA7.5A	8.33	9.21	1.0	7.5	50	38.8	12.9	7
SA8.0A	8.89	9.83	1.0	8.0	25	36.8	13.6	7
SA8.5A	9.44	10.4	1.0	8.5	10	34.7	14.4	8
SA9.0A	10.0	11.1	1.0	9.0	5.0	32.5	15.4	9
SA10A	11.1	12.3	1.0	10	1.0	29.4	17.0	10
SA11A	12.2	13.5	1.0	11	1.0	27.5	18.2	11
SA12A	13.3	14.7	1.0	12	1.0	25.1	19.9	12
SA13A	14.4	15.9	1.0	13	1.0	23.3	21.5	13
SA14A	15.6	17.2	1.0	14	1.0	21.6	23.2	14
SA15A	16.7	18.5	1.0	15	1.0	20.5	24.4	16
SA16A	17.8	19.7	1.0	16	1.0	19.2	26.0	17
SA17A	18.9	20.9	1.0	17	1.0	18.1	27.6	19
SA18A	20.0	22.1	1.0	18	1.0	17.1	29.2	20
SA20A	22.2	24.5	1.0	20	1.0	15.4	32.4	23
SA22A	24.4	26.9	1.0	22	1.0	14.1	35.5	25
SA24A	26.7	29.5	1.0	24	1.0	12.9	38.9	28
SA26A	28.9	31.9	1.0	26	1.0	11.9	42.1	30
SA28A	31.1	34.4	1.0	28	1.0	11	45.4	31
SA30A	33.3	36.8	1.0	30	1.0	10	48.4	36
SA33A	36.7	40.6	1.0	33	1.0	9.4	53.3	39
SA36A	40.0	44.2	1.0	36	1.0	8.6	58.1	41
SA40A	44.4	49.1	1.0	40	1.0	7.8	64.5	46
SA43A	47.8	52.8	1.0	43	1.0	7.2	69.4	50
SA45A	50.0	55.3	1.0	45	1.0	6.9	72.7	52
SA48A	53.3	58.9	1.0	48	1.0	6.5	77.4	56
SA51A	56.7	62.7	1.0	51	1.0	6.1	82.4	61
SA54A	60.0	66.3	1.0	54	1.0	5.7	87.1	65
SA58A	64.4	71.2	1.0	58	1.0	5.3	93.6	70
SA60A	66.7	73.7	1.0	60	1.0	5.2	96.8	71
SA64A	71.1	78.6	1.0	64	1.0	4.9	103	76
SA70A	77.8	86.0	1.0	70	1.0	4.4	113	85
SA75A	83.3	92.1	1.0	75	1.0	4.1	121	91
SA78A	86.7	95.8	1.0	78	1.0	4	126	95
SA85A	94.4	104	1.0	85	1.0	3.6	137	103
SA90A	100	111	1.0	90	1.0	3.4	146	110
SA100A	111	123	1.0	100	1.0	3.1	162	123
SA110A	122	135	1.0	110	1.0	2.8	177	133
SA120A	133	147	1.0	120	1.0	2.6	193	146
SA130A	144	159	1.0	130	1.0	2.4	209	158
SA150A	167	185	1.0	150	1.0	2.1	243	184
SA160A	178	197	1.0	160	1.0	1.9	259	196
SA170A	189	209	1.0	170	1.0	1.8	275	208

Notes

- (1) Pulse test: $t_p \leq 50\text{ }\mu\text{s}$
- (2) Surge current waveform per fig. 3 and derate per fig. 2
- (3) For bi-directional types with V_{WM} of 10 V and less the I_D limit is doubled
- (4) For the bi-directional SA5.0CA, the maximum V_{BR} is 7.25 V
- (5) All terms and symbols are consistent with ANSI/IEEE CA62.35

ORDERING INFORMATION (Example)				
PREFERRED PIN	UNIT WEIGHT (g)	PREFERRED PACKAGE CODE	BASE QUANTITY	DELIVERY MODE
SA5.0A-E3/54	0.432	54	4000	13" diameter paper tape and reel
SA5.0AHE3/54 (1)	0.432	54	4000	13" diameter paper tape and reel

Note

(1) AEC-Q101 qualified

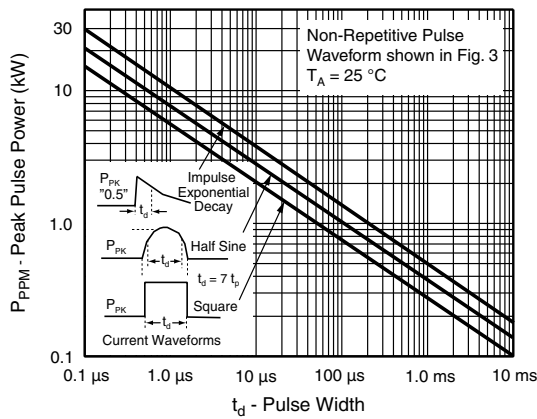
RATINGS AND CHARACTERISTICS CURVES ($T_A = 25^\circ\text{C}$ unless otherwise noted)


Fig. 1 - Peak Pulse Power Rating Curve

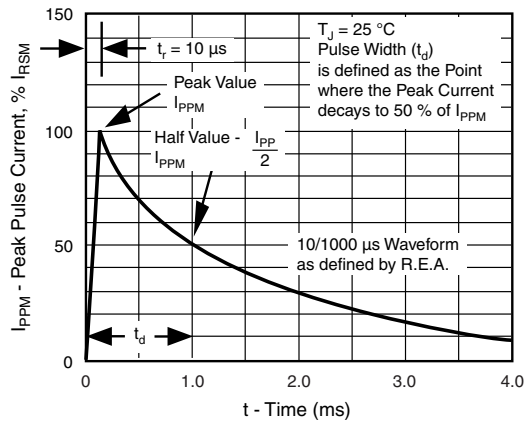


Fig. 3 - Pulse Waveform

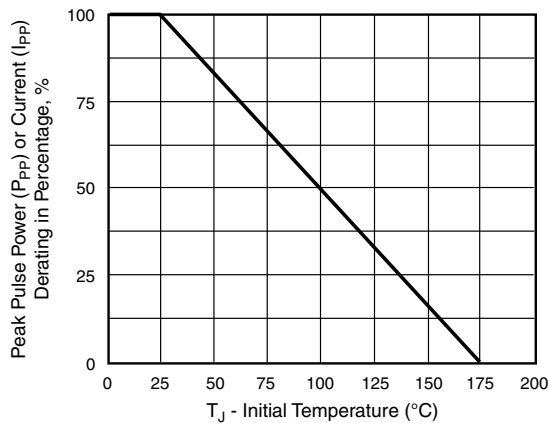


Fig. 2 - Pulse Derating Curve

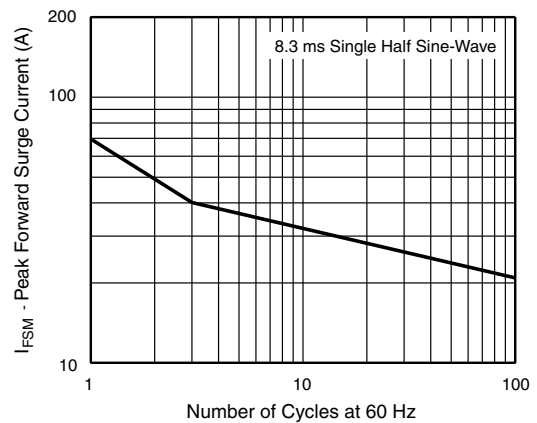


Fig. 4 - Maximum Non-Repetitive Forward Surge Current Uni-Directional Only

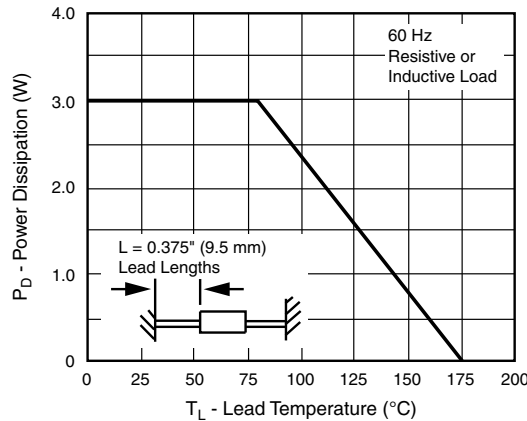


Fig. 5 - Steady State Power Derating Curve

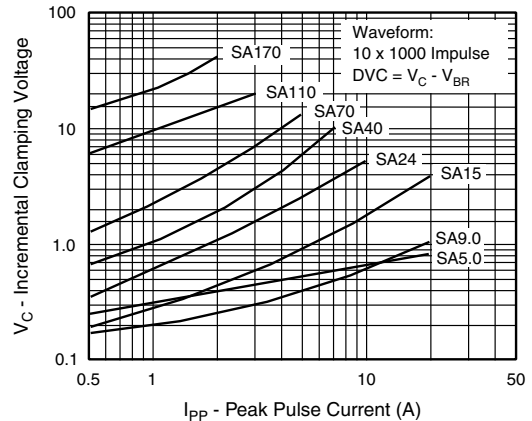


Fig. 8 - Incremental Clamping Voltage Curve Uni-Directional

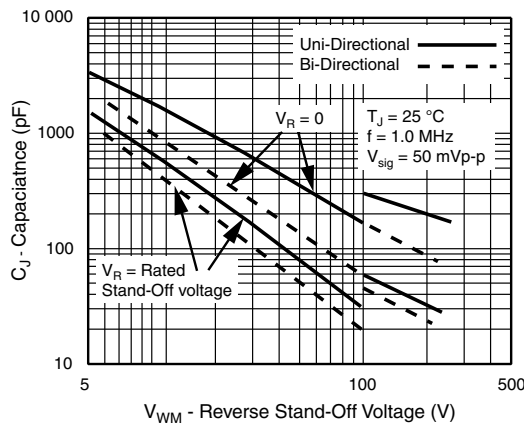


Fig. 6 - Capacitance

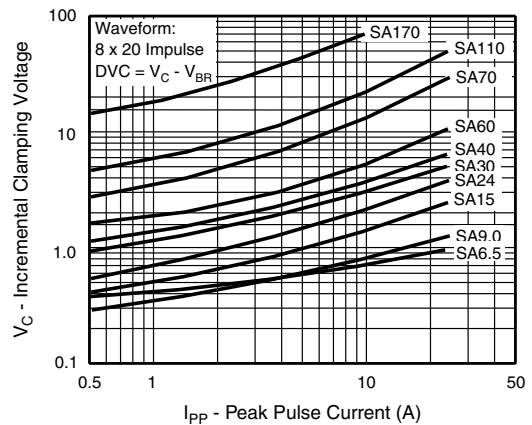


Fig. 9 - Incremental Clamping Voltage Curve Bi-Directional

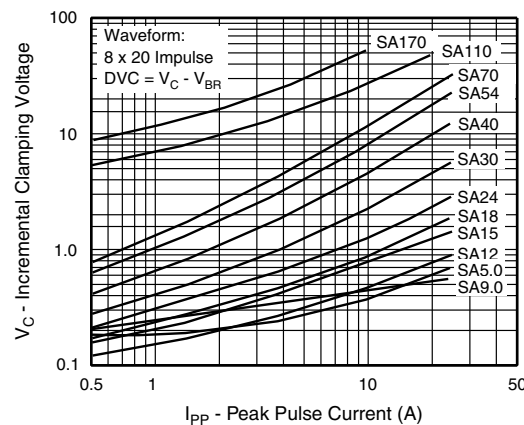


Fig. 7 - Incremental Clamping Voltage Curve Uni-Directional

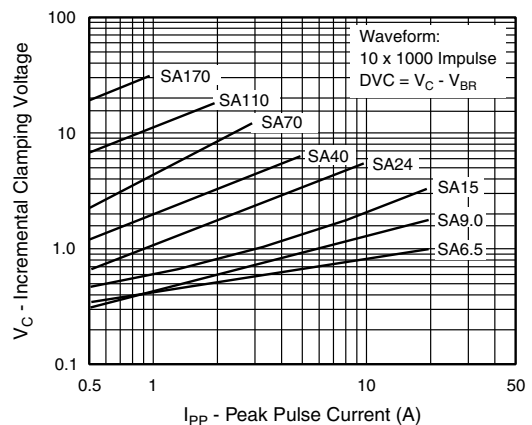


Fig. 10 - Incremental Clamping Voltage Curve Bi-Directional

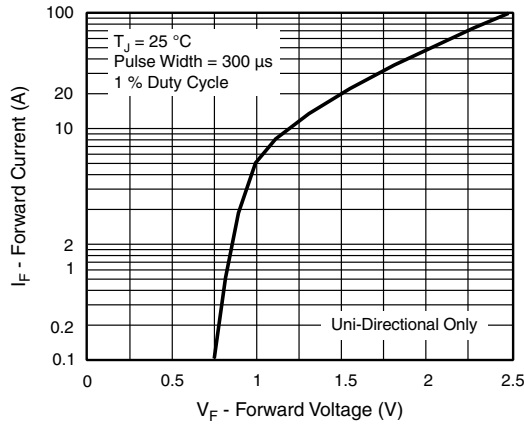


Fig. 11 - Typical Instantaneous Forward Voltage

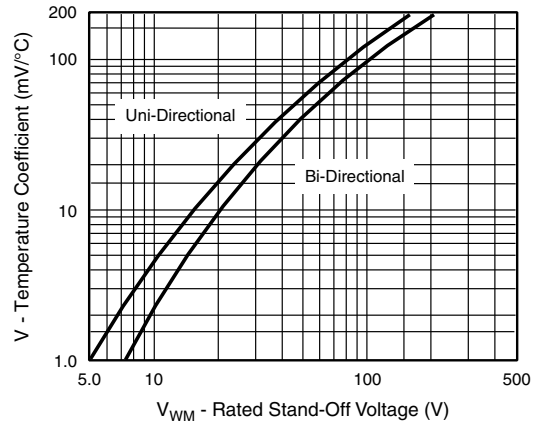
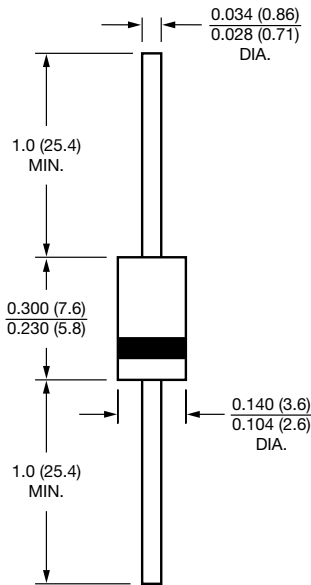


Fig. 12 - Breakdown Voltage Temperature Coefficient Curve

PACKAGE OUTLINE DIMENSIONS in inches (millimeters)

DO-15 (DO-204AC)





Disclaimer

ALL PRODUCT, PRODUCT SPECIFICATIONS AND DATA ARE SUBJECT TO CHANGE WITHOUT NOTICE TO IMPROVE RELIABILITY, FUNCTION OR DESIGN OR OTHERWISE.

Vishay Intertechnology, Inc., its affiliates, agents, and employees, and all persons acting on its or their behalf (collectively, "Vishay"), disclaim any and all liability for any errors, inaccuracies or incompleteness contained in any datasheet or in any other disclosure relating to any product.

Vishay makes no warranty, representation or guarantee regarding the suitability of the products for any particular purpose or the continuing production of any product. To the maximum extent permitted by applicable law, Vishay disclaims (i) any and all liability arising out of the application or use of any product, (ii) any and all liability, including without limitation special, consequential or incidental damages, and (iii) any and all implied warranties, including warranties of fitness for particular purpose, non-infringement and merchantability.

Statements regarding the suitability of products for certain types of applications are based on Vishay's knowledge of typical requirements that are often placed on Vishay products in generic applications. Such statements are not binding statements about the suitability of products for a particular application. It is the customer's responsibility to validate that a particular product with the properties described in the product specification is suitable for use in a particular application. Parameters provided in datasheets and / or specifications may vary in different applications and performance may vary over time. All operating parameters, including typical parameters, must be validated for each customer application by the customer's technical experts. Product specifications do not expand or otherwise modify Vishay's terms and conditions of purchase, including but not limited to the warranty expressed therein.

Except as expressly indicated in writing, Vishay products are not designed for use in medical, life-saving, or life-sustaining applications or for any other application in which the failure of the Vishay product could result in personal injury or death. Customers using or selling Vishay products not expressly indicated for use in such applications do so at their own risk. Please contact authorized Vishay personnel to obtain written terms and conditions regarding products designed for such applications.

No license, express or implied, by estoppel or otherwise, to any intellectual property rights is granted by this document or by any conduct of Vishay. Product names and markings noted herein may be trademarks of their respective owners.