

### Features

- Planar Die Construction
- 350mW Power Dissipation
- 2.4V – 51V Nominal Zener Voltage
- 2% Standard Vz Tolerance
- Designed for Surface Mount Application
- Plastic Material – UL Recognition Flammability Classification 94V-0

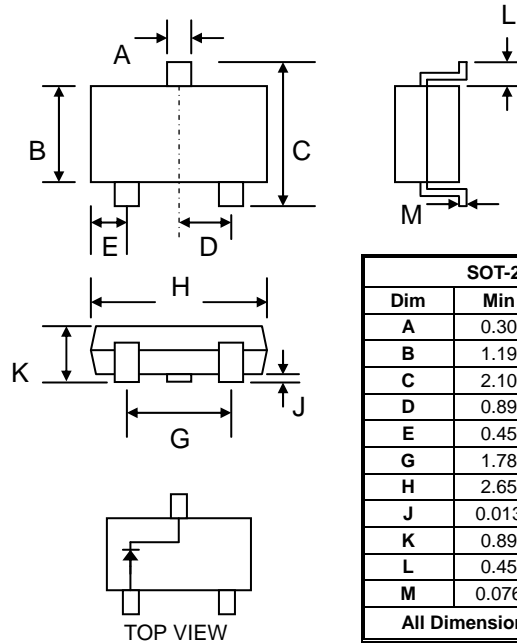

SOT-23		
Dim	Min	Max
A	0.30	0.50
B	1.19	1.40
C	2.10	2.50
D	0.89	1.05
E	0.45	0.61
G	1.78	2.05
H	2.65	3.05
J	0.013	0.15
K	0.89	1.10
L	0.45	0.61
M	0.076	0.178
All Dimensions in mm		

### Mechanical Data

- Case: SOT-23, Molded Plastic
- Terminals: Plated Leads Solderable per MIL-STD-202, Method 208
- Polarity: See Diagram
- Weight: 0.008 grams (approx.)
- Mounting Position: Any
- Marking: Device Code
- **Lead Free: For RoHS / Lead Free Version, Add “-LF” Suffix to Part Number, See Page 5**

### Maximum Ratings @ $T_A=25^{\circ}\text{C}$ unless otherwise specified

Characteristic	Symbol	Value	Unit
Peak Pulse Power Dissipation at $T_A = 25^{\circ}\text{C}$ (Note 1)	$P_D$	350	mW
Forward Voltage @ $I_F = 10\text{mA}$	$V_F$	0.9	V
Thermal Resistance Junction to Ambient (Note 1, 2)	$R_{JA}$	357	$^{\circ}\text{C/W}$
Operating and Storage Temperature Range	$T_j, T_{STG}$	-65 to +150	$^{\circ}\text{C}$

Note: 1. Mounted on FR-4 PCB with minimum recommended pad layout.  
 2. Thermal resistance measurement obtained via infrared scan method.

# BZX84B2V4 – BZX84B51

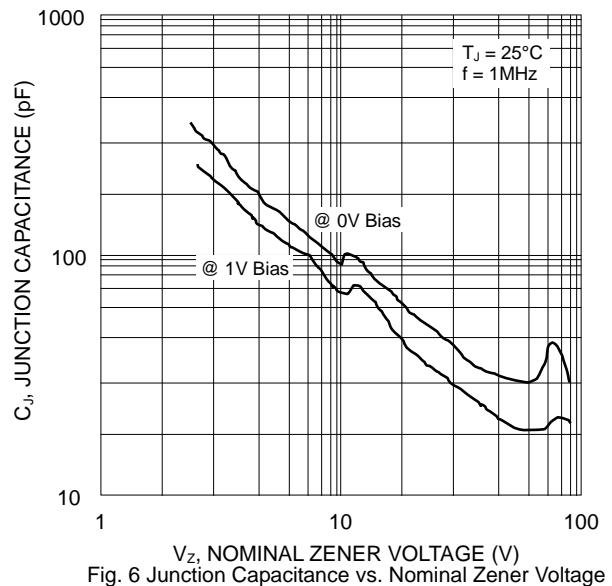
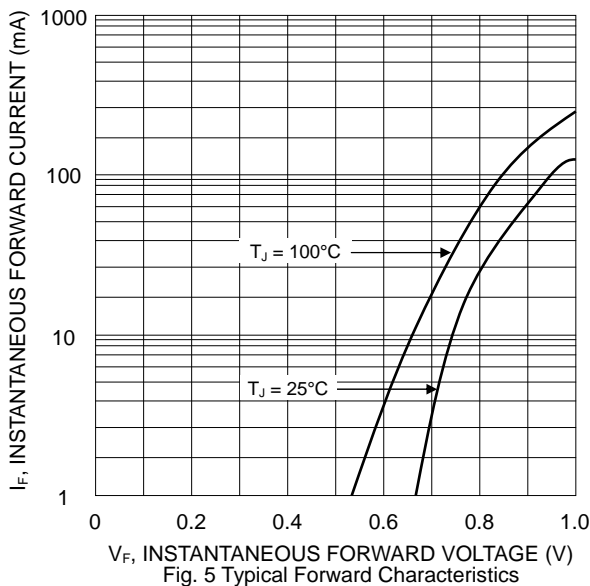
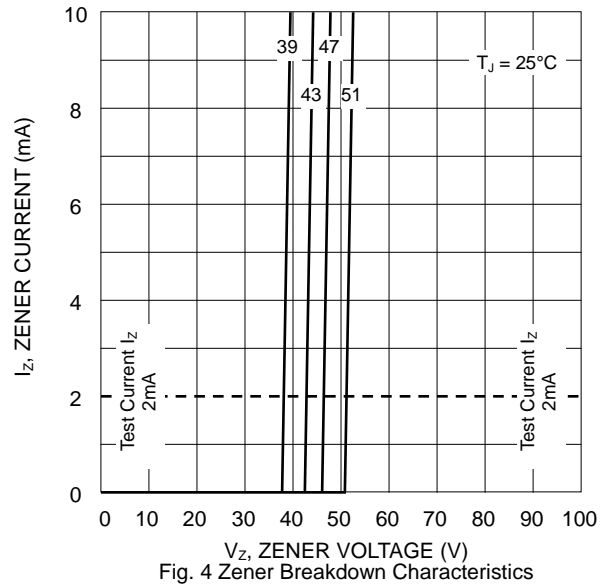
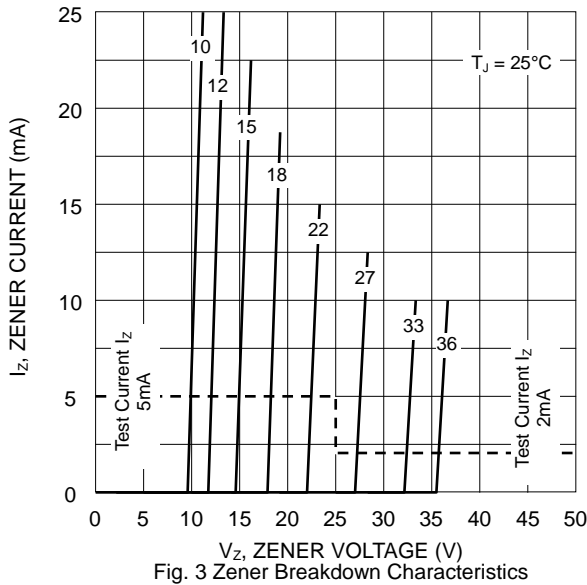
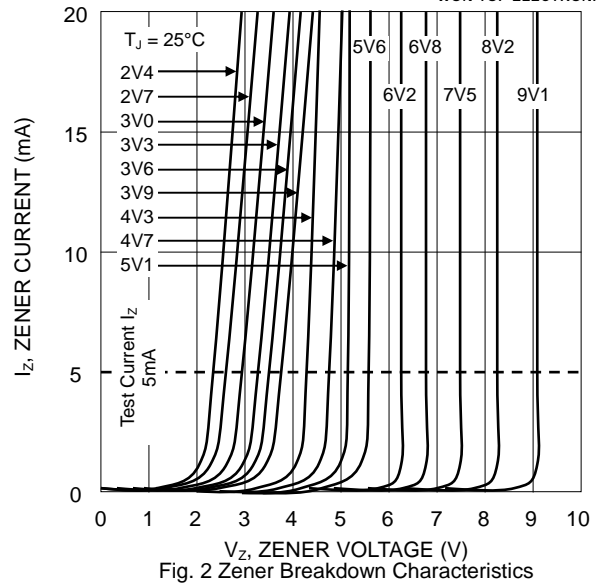
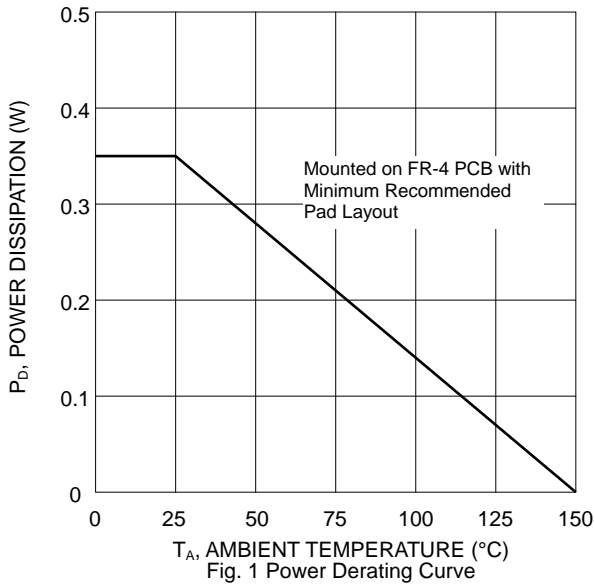

**Electrical Characteristics (@T<sub>A</sub>=25°C unless otherwise specified) Table 1**

Type Number (Note 1)	Device Marking Code (Note 2)		Zener Voltage Range (Note 3)			Maximum Zener Impedance (Note 4)				Max Reverse Leakage Current		Temp. Coefficient of Zener Voltage @ I <sub>ZT</sub> (mV/K)	
			V <sub>Z</sub> @ I <sub>ZT</sub>			Z <sub>ZT</sub> @ I <sub>ZT</sub>		Z <sub>ZK</sub> @ I <sub>ZK</sub>		I <sub>R</sub>	@ V <sub>R</sub>		
	TW	CN	Nom (V)	Min (V)	Max (V)	( )	(mA)	( )	(mA)	(μA)	(V)	Min	Max
BZX84B2V4	W1	Z50	2.4	2.35	2.45	100	5.0	600	1.0	50	1.0	-3.5	0
BZX84B2V7	W2	Z51	2.7	2.65	2.75	100	5.0	600	1.0	20	1.0	-3.5	0
BZX84B3V0	W3	Z52	3.0	2.94	3.06	95	5.0	600	1.0	10	1.0	-3.5	0
BZX84B3V3	W4	Z53	3.3	3.23	3.37	95	5.0	600	1.0	5.0	1.0	-3.5	0
BZX84B3V6	W5	Z54	3.6	3.53	3.67	90	5.0	600	1.0	5.0	1.0	-3.5	0
BZX84B3V9	W6	Z55	3.9	3.82	3.98	90	5.0	600	1.0	3.0	1.0	-3.5	0
BZX84B4V3	W7	Z56	4.3	4.21	4.39	90	5.0	600	1.0	3.0	1.0	-3.5	0
BZX84B4V7	W8	Z57	4.7	4.61	4.79	80	5.0	500	1.0	3.0	2.0	-3.5	0.2
BZX84B5V1	W9	Z58	5.1	5.00	5.20	60	5.0	480	1.0	2.0	2.0	-2.7	1.2
BZX84B5V6	WA	Z59	5.6	5.49	5.71	40	5.0	400	1.0	1.0	2.0	-2.0	2.5
BZX84B6V2	WB	Z60	6.2	6.08	6.32	10	5.0	150	1.0	3.0	4.0	0.4	3.7
BZX84B6V8	WC	Z61	6.8	6.66	6.94	15	5.0	80	1.0	2.0	4.0	1.2	4.5
BZX84B7V5	WD	Z62	7.5	7.35	7.65	15	5.0	80	1.0	1.0	5.0	2.5	5.3
BZX84B8V2	WE	Z63	8.2	8.04	8.36	15	5.0	80	1.0	0.7	5.0	3.2	6.2
BZX84B9V1	WF	Z64	9.1	8.92	9.28	15	5.0	100	1.0	0.5	6.0	3.8	7.0
BZX84B10	WG	Z65	10	9.80	10.20	20	5.0	150	1.0	0.2	7.0	4.5	8.0
BZX84B11	WH	Z66	11	10.80	11.20	20	5.0	150	1.0	0.1	8.0	5.4	9.0
BZX84B12	WI	Z67	12	11.80	12.20	25	5.0	150	1.0	0.1	8.0	6.0	10.0
BZX84B13	WK	Z68	13	12.70	13.30	30	5.0	170	1.0	0.1	8.0	7.0	11.0
BZX84B15	WL	Z69	15	14.70	15.30	30	5.0	200	1.0	0.05	10.5	9.2	13.0
BZX84B16	WM	Z70	16	15.70	16.30	40	5.0	200	1.0	0.05	11.2	10.4	14.0
BZX84B18	WN	Z71	18	17.60	18.40	45	5.0	225	1.0	0.05	12.6	12.4	16.0
BZX84B20	WO	Z72	20	19.60	20.40	55	5.0	225	1.0	0.05	14.0	14.4	18.0
BZX84B22	WP	Z73	22	21.60	22.40	55	5.0	250	1.0	0.05	15.4	16.4	20.0
BZX84B24	WR	Z74	24	23.50	24.50	70	5.0	250	1.0	0.05	16.8	18.4	22.0
BZX84B27	WS	Z75	27	26.50	27.50	80	2.0	300	0.5	0.05	18.9	21.4	25.3
BZX84B30	WT	Z76	30	29.40	30.60	80	2.0	300	0.5	0.05	21.0	24.4	29.4
BZX84B33	WU	Z77	33	32.30	33.70	80	2.0	325	0.5	0.05	23.1	27.4	33.4
BZX84B36	WW	Z78	36	35.30	36.70	90	2.0	350	0.5	0.05	25.2	30.4	37.4
BZX84B39	WX	Z79	39	38.20	39.80	130	2.0	350	0.5	0.05	27.3	33.4	41.2
BZX84B43	WY	Z80	43	42.10	43.90	150	2.0	375	0.5	0.05	30.1	37.6	46.6
BZX84B47	WZ	Z81	47	46.10	47.90	170	2.0	375	0.5	0.05	32.9	42.0	51.8
BZX84B51	XA	Z82	51	50.00	52.00	180	2.0	400	0.5	0.05	35.7	46.6	57.2

- Note: 1. Type numbers listed have standard tolerance on the nominal zener voltage of ±2%.  
 2. TW: Marking code for Taiwan plant. CN: Marking code for China plant.  
 3. Measured with pulse test current I<sub>Z</sub> at ambient temperature 25°C.  
 4. f = 1KHz

## MARKING INFORMATION

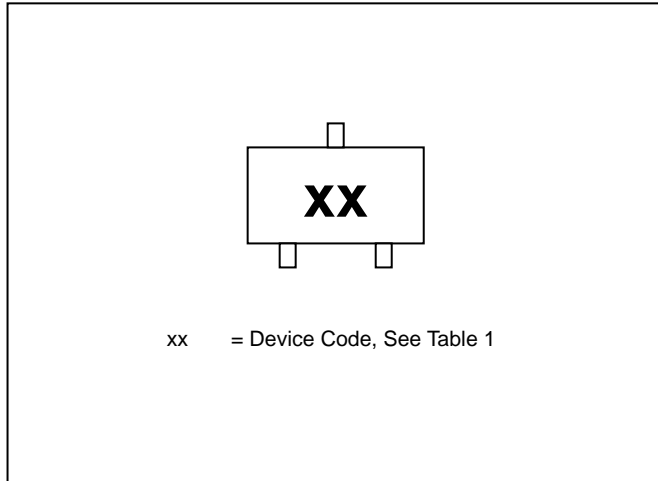

## RECOMMENDED FOOTPRINT

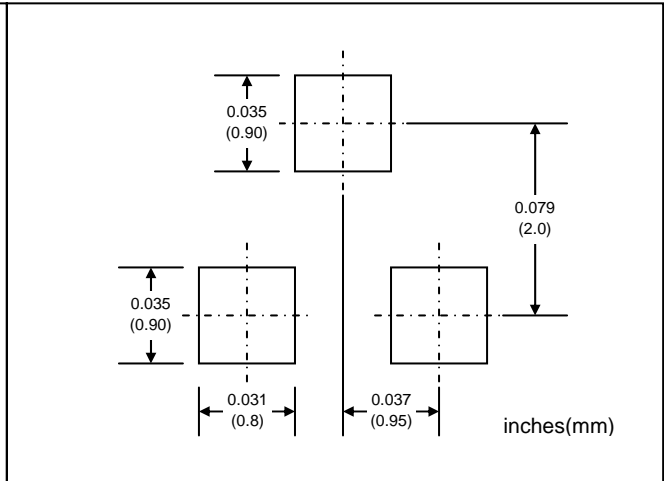

## PACKAGING INFORMATION

### TAPE & REEL

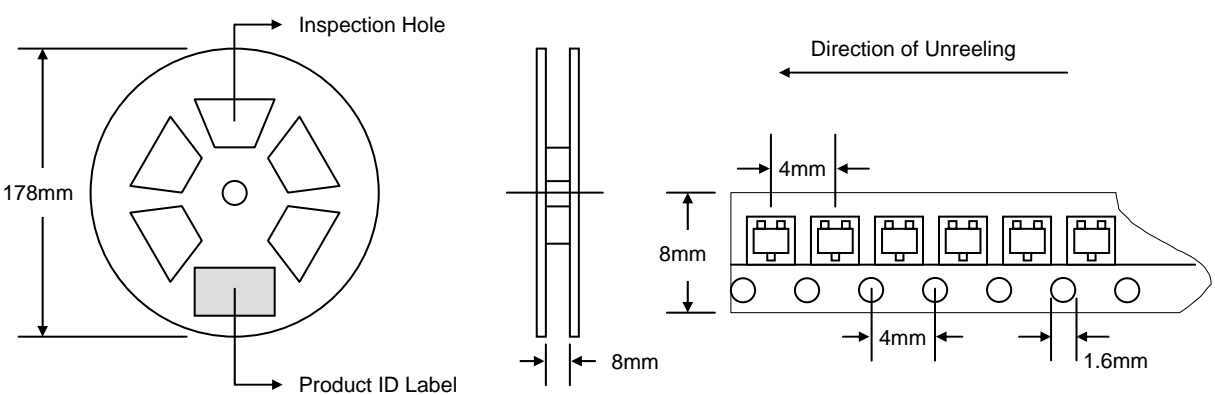

Reel Diameter (mm)	Quantity (PCS)	Inner Box Size L x W x H (mm)	Quantity (PCS)	Carton Size L x W x H (mm)	Quantity (PCS)	Approx. Gross Weight (KG)
178	3,000	187 x 187 x 65	15,000	390 x 240 x 420	150,000	10.0

**Note:** 1. Anti-static plastic reel, white, water clear or blue color. Inspection hole might be varied in different alignment.  
2. Components are packed in accordance with EIA standard 481-1 and 481-2.

## ORDERING INFORMATION

Product No.	Package Type	Shipping Quantity
BZX84Bxx-T1	SOT-23	3000/Tape & Reel

1. Shipping quantity given is for minimum packing quantity only. For minimum order quantity, please consult the Sales Department.
2. **To order RoHS / Lead Free version (with Lead Free finish), add "-LF" suffix to part number above. For example, BZX84B2V4-T1-LF.**

WON-TOP ELECTRONICS and  are registered trademarks of Won-Top Electronics Co., Ltd (WTE). WTE has checked all information carefully and believes it to be correct and accurate. However, WTE cannot assume any responsibility for inaccuracies. Furthermore, this information does not give the purchaser of semiconductor devices any license under patent rights to manufacturer. WTE reserves the right to change any or all information herein without further notice.

**WARNING:** DO NOT USE IN LIFE SUPPORT EQUIPMENT. WTE power semiconductor products are not authorized for use as critical components in life support devices or systems without the express written approval.

**Won-Top Electronics Co., Ltd.**  
No. 44 Yu Kang North 3rd Road,  
Chine Chen Dist., Kaohsiung 806, Taiwan  
**Phone:** 886-7-822-5408 or 886-7-822-5410  
**Fax:** 886-7-822-5417  
**Email:** sales@wontop.com  
**Internet:** <http://www.wontop.com>

*We power your everyday.*