

CDST-21/A/C/S-HF

Reverse Voltage: 250 Volts

Forward Current: 200 mA

RoHS Device

Halogen Free

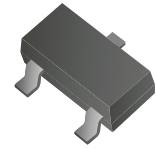

Features

- Fast switching speed.
- Surface mount package ideally suited for automatic insertion.
- For general purpose switching applications.
- High conductance.

Mechanical data

- Case: SOT-23, molded plastic.
- Terminals: Solderable per MIL-STD-750, method 2026.
- Weight: 0.008 grams(Approx.)

Circuit diagram

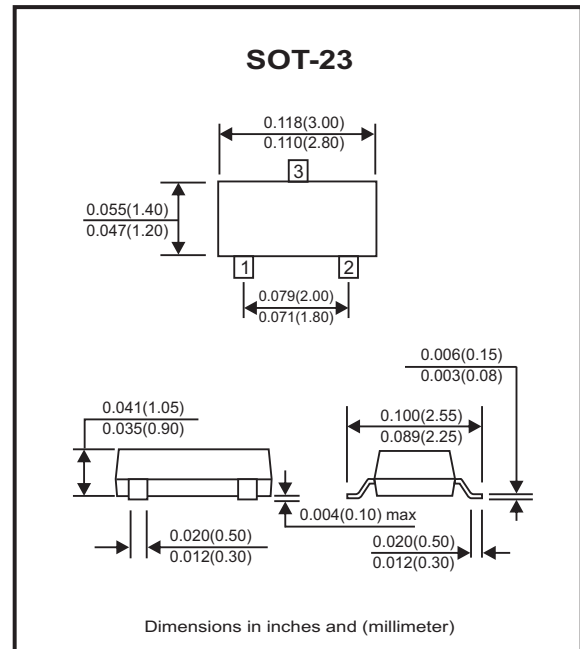
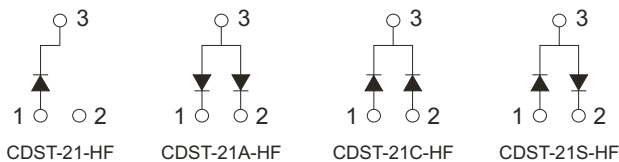

Maximum Ratings (at Ta=25°C unless otherwise noted)

Parameter	Conditions	Symbol	Value	Unit
Repetitive peak reverse voltage		V_{RRM}	250	V
Working peak reverse voltage		V_{RWM}	250	V
DC reverse voltage		V_R	250	V
Average rectified output current		I_o	200	mA
Non-Repetitive Peak forward surge current	t=8.3ms	I_{FSM}	2.5	A
Repetitive peak forward surge current		I_{FRM}	625	mA
Power dissipation		P_D	225	mW
Thermal resistance	Junction to ambient	$R_{\theta JA}$	555	°C/W
Junction temperature range		T_J	150	°C
Storage temperature range		T_{STG}	-55 to +150	°C

Electrical Characteristics (at Ta=25°C unless otherwise noted)

Parameter	Conditions	Symbol	Min.	Max.	Unit
Reverse breakdown voltage	$I_R = 100\mu A$	$V_{(BR)}$	250		V
Reverse voltage leakage current	$V_R = 200V$	I_R		0.1	μA
Forward voltage	$I_F = 100mA$ $I_F = 200mA$	V_F		1000 1250	mV
Diode Capacitance	$V_R = 0V, f = 1MHz$	C_D		5	pF
Reverse recovery time	$I_F = I_R = 30mA, I_{rr} = 0.1 \times I_R, R_L = 100\Omega$	T_{rr}		50	nS

RATING AND CHARACTERISTIC CURVES (CDST-21/A/C/S-HF)

Fig.1 - Typical Forward Characteristics

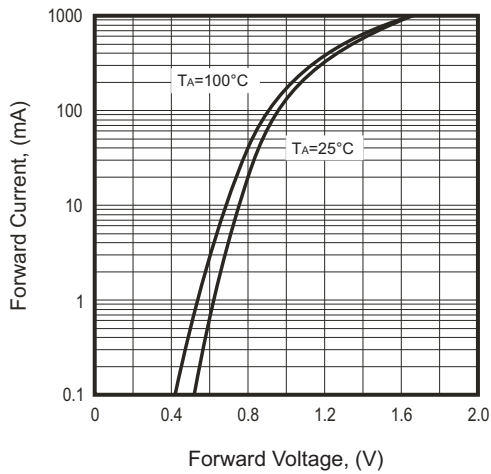

Fig.2 - Typical Reverse Characteristics

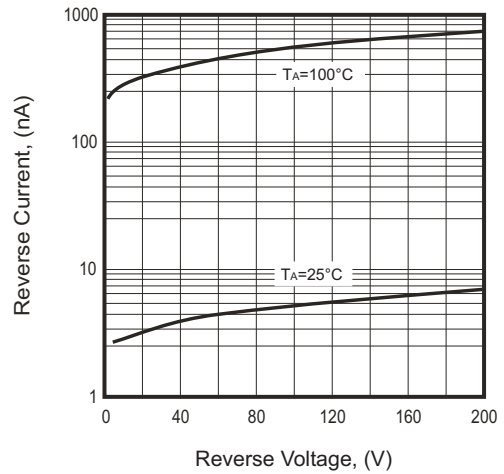

Fig.3 - Capacitance Between

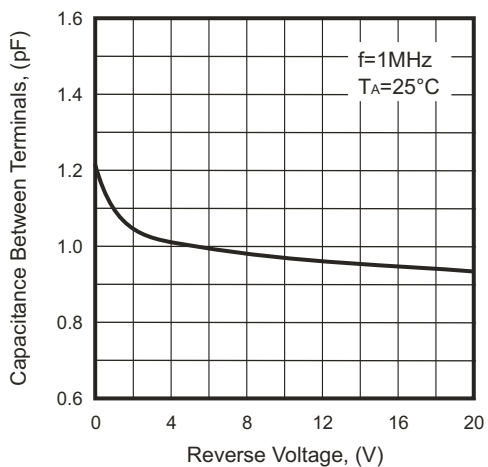
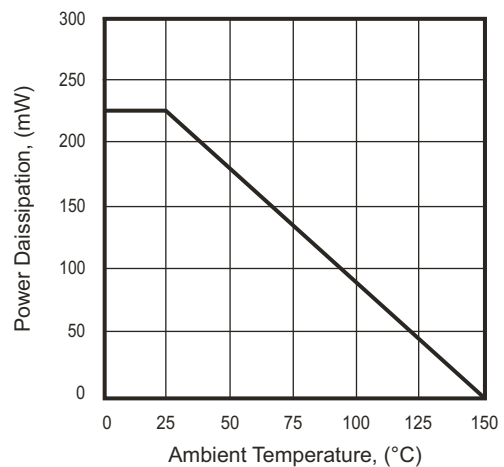
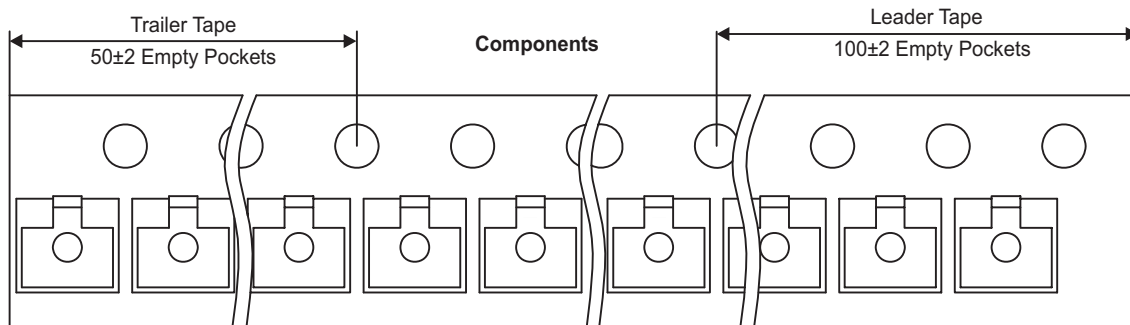
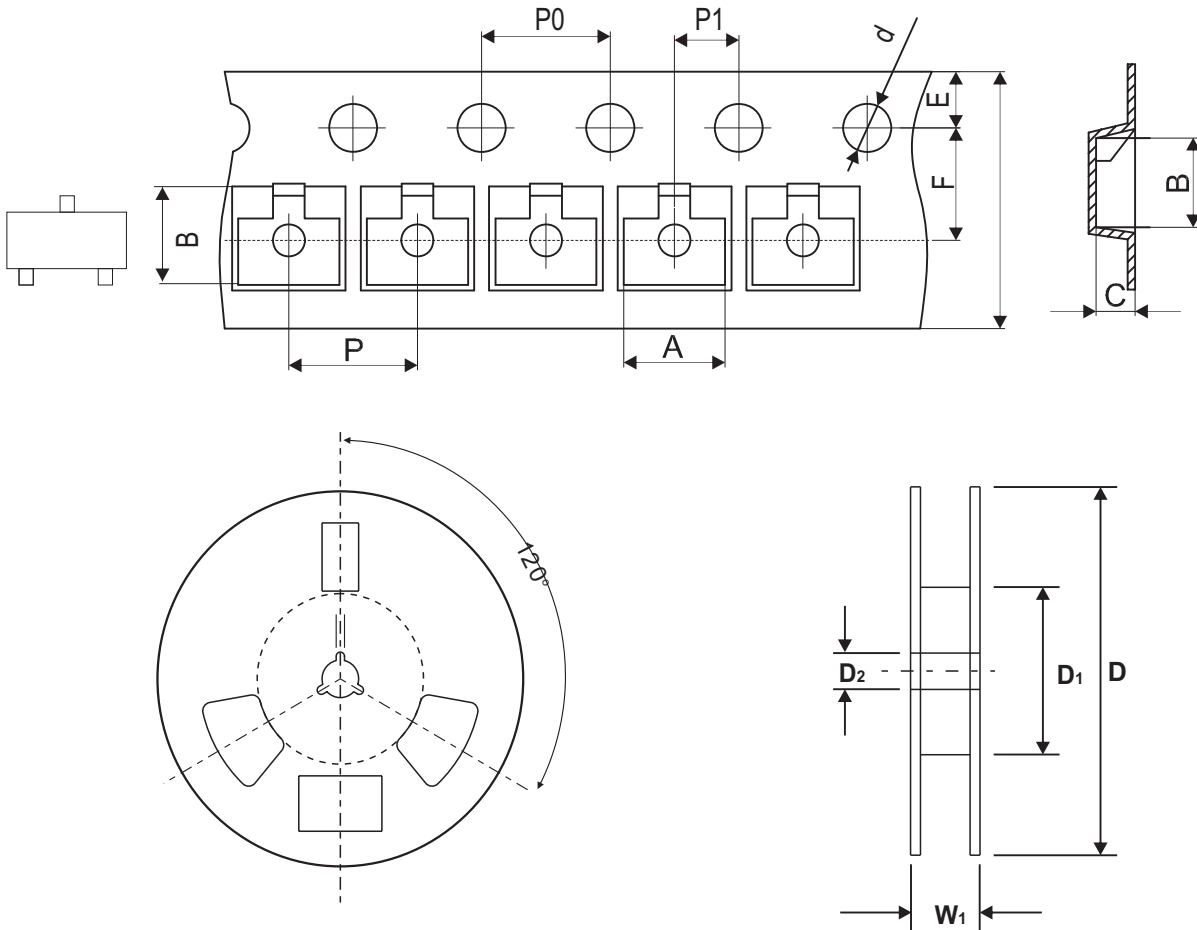

Fig.4 - Power Derating Curve



Reel Taping Specification



SOT-23	SYMBOL	A	B	C	d	D	D1	D2
	(mm)	3.15 ± 0.10	2.77 ± 0.10	1.22 ± 0.10	1.50 ± 0.10	178.00 ± 2.00	54.40 ± 1.00	13.00 ± 1.00
	(inch)	0.124 ± 0.004	0.109 ± 0.004	0.048 ± 0.004	0.059 ± 0.004	7.008 ± 0.079	2.142 ± 0.039	0.512 ± 0.039

SOT-23	SYMBOL	E	F	P	P0	P1	W	W1
	(mm)	1.75 ± 0.10	3.50 ± 0.10	4.00 ± 0.10	4.00 ± 0.10	2.00 ± 0.10	8.00 + 0.30 / - 0.10	12.30 ± 1.00
	(inch)	0.069 ± 0.004	0.138 ± 0.004	0.157 ± 0.004	0.157 ± 0.004	0.079 ± 0.004	0.315 + 0.012 / - 0.004	0.484 ± 0.039

Company reserves the right to improve product design, functions and reliability without notice.

Marking Code

Part Number	Marking Code
CDST-21-HF	JS
CDST-21A-HF	JS2
CDST-21C-HF	JS3
CDST-21S-HF	JS4

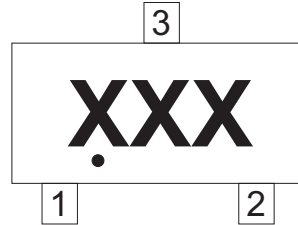

xx/xxx = Product type marking code

Suggested PAD Layout

SIZE	SOT-23	
	(mm)	(inch)
A	0.90	0.035
B	0.80	0.031
C	0.95	0.037
D	2.00	0.079
E	2.90	0.114

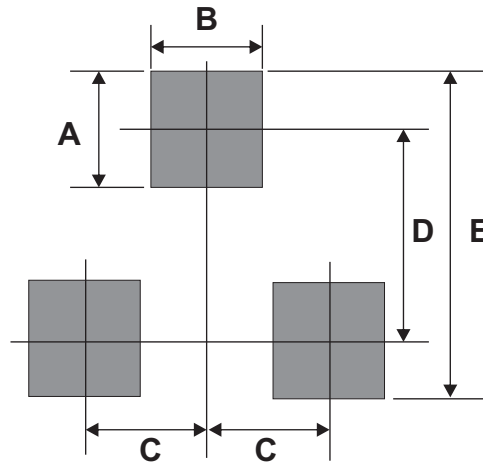

Standard Packaging

Case Type	REEL PACK	
	REEL (pcs)	Reel Size (inch)
SOT-23	3,000	7