

Main Product Characteristics

$V_{(BR)DSS}$	30V
$R_{DS(ON)}$	18m Ω
I_D	28A

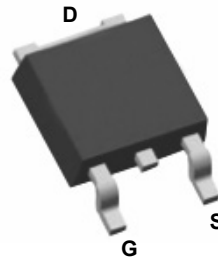

TO-252 (DPAK)

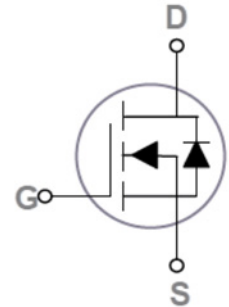

Schematic Diagram

Features and Benefits

- Advanced MOSFET process technology
- Ideal for high efficiency switched mode power supplies
- Low on-resistance with low gate charge
- Fast switching and reverse body recovery



Description

The SSFD3912 utilizes the latest techniques to achieve high cell density and low on-resistance. These features make this device extremely efficient and reliable for use in high efficiency switch mode power supply and a wide variety of other applications.

Absolute Maximum Ratings (T_c=25°C unless otherwise specified)

Parameter	Symbol	Rating	Unit
Drain-Source Voltage	V _{DS}	30	V
Gate-Source Voltage	V _{GS}	±20	V
Drain Current – Continuous (T _c =25°C)	I _D	28	A
Drain Current – Continuous (T _c =100°C)		17.7	A
Drain Current – Pulsed ¹	I _{DM}	112	A
Single Pulse Avalanche Energy ²	E _{AS}	18	mJ
Single Pulse Avalanche Current ²	I _{AS}	19	A
Power Dissipation (T _c =25°C)	P _D	24.9	W
Power Dissipation – Derate above 25°C		0.20	W/°C
Storage Temperature Range	T _{STG}	-55 to +150	°C
Operating Junction Temperature Range	T _J	-55 to +150	°C

Thermal Characteristics

Parameter	Symbol	Typ.	Max.	Unit
Thermal Resistance Junction to Ambient	R _{θJA}	---	62	°C/W
Thermal Resistance Junction to Case	R _{θJC}	---	5.02	°C/W

Electrical Characteristics (T_J=25°C unless otherwise specified)

Parameter	Symbol	Conditions	Min.	Typ.	Max.	Unit
Off Characteristics						
Drain-Source Breakdown Voltage	BV _{DSS}	V _{GS} =0V, I _D =250μA	30	---	---	V
BV _{DSS} Temperature Coefficient	ΔBV _{DSS} /ΔT _J	Reference to 25°C, I _D =1mA	---	0.04	---	V/°C
Drain-Source Leakage Current	I _{DSS}	V _{DS} =30V, V _{GS} =0V, T _J =25°C	---	---	1	μA
		V _{DS} =24V, V _{GS} =0V, T _J =125°C	---	---	10	μA
Gate-Source Leakage Current	I _{GSS}	V _{GS} =±20V, V _{DS} =0V	---	---	±100	nA
On Characteristics						
Static Drain-Source On-Resistance ³	R _{DS(ON)}	V _{GS} =10V, I _D =12A	---	14	18	mW
		V _{GS} =4.5V, I _D =8A	---	18	24	mW
Gate Threshold Voltage	V _{GS(th)}	V _{GS} =V _{DS} , I _D =250μA	1.2	1.6	2.5	V
V _{GS(th)} Temperature Coefficient	ΔV _{GS(th)}		---	-4	---	mV/°C
Forward Transconductance	g _{fs}	V _{DS} =10V, I _D =6A	---	8	---	S
Dynamic and Switching Characteristics						
Total Gate Charge ^{3, 4}	Q _g	V _{DS} =15V, V _{GS} =10V, I _D =10A	---	5.2	10	nC
Gate-Source Charge ^{3, 4}	Q _{gs}		---	0.6	1.2	
Gate-Drain Charge ^{3, 4}	Q _{gd}		---	2	4	
Turn-On Delay Time ^{3, 4}	T _{d(on)}	V _{DD} =15V, V _{GS} =10V, R _G =6Ω, I _D =1A	---	2.8	5	nS
Rise Time ^{3, 4}	T _r		---	7.2	14	
Turn-Off Delay Time ^{3, 4}	T _{d(off)}		---	15.8	30	
Fall Time ^{3, 4}	T _f		---	4.6	9	
Input Capacitance	C _{iss}	V _{DS} =25V, V _{GS} =0V, F=1MHz	---	370	740	pF
Output Capacitance	C _{oss}		---	70	140	
Reverse Transfer Capacitance	C _{rss}		---	50	100	
Gate resistance	R _g	V _{GS} =0V, V _{DS} =0V, F=1MHz	---	2.2	4.5	W
Drain-Source Diode Characteristics and Maximum Ratings						
Parameter	Symbol	Conditions	Min.	Typ.	Max.	Unit
Continuous Source Current	I _S	V _G =V _D =0V, Force Current	---	---	28	A
Pulsed Source Current ³	I _{SM}		---	---	56	A
Diode Forward Voltage ³	V _{SD}	V _{GS} =0V, I _S =1A, T _J =25°C	---	---	1	V

Note:

1. Repetitive Rating: Pulsed width limited by maximum junction temperature.
2. V_{DD}=25V, V_{GS}=10V, L=1mH, I_{AS}=19A, R_G=25Ω, Starting T_J=25°C.
3. The data tested by pulsed, pulse width ≤ 300μs, duty cycle ≤ 2%.
4. Essentially independent of operating temperature.

Typical Electrical and Thermal Characteristic Curves

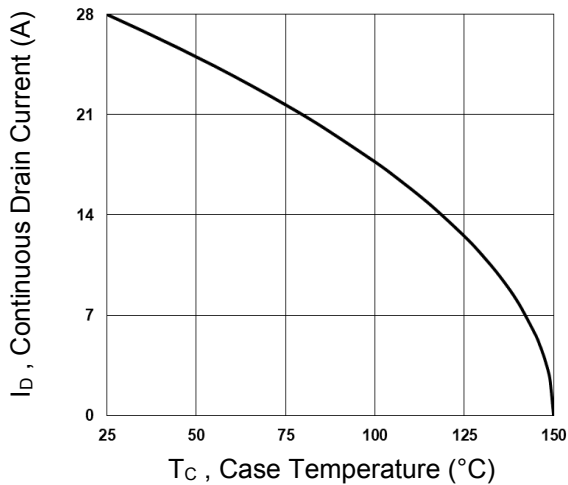

Fig.1 Continuous Drain Current vs. T_c

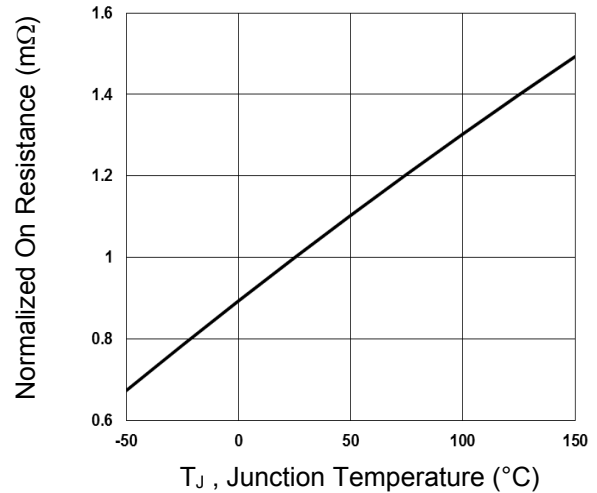

Fig.2 Normalized $R_{DS(ON)}$ vs. T_j

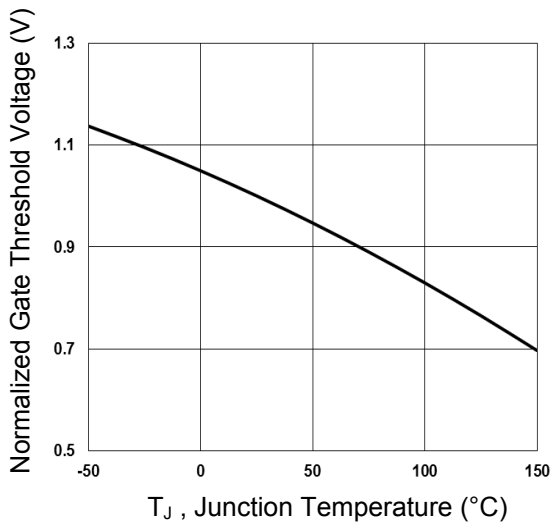

Fig.3 Normalized V_{th} vs. T_j

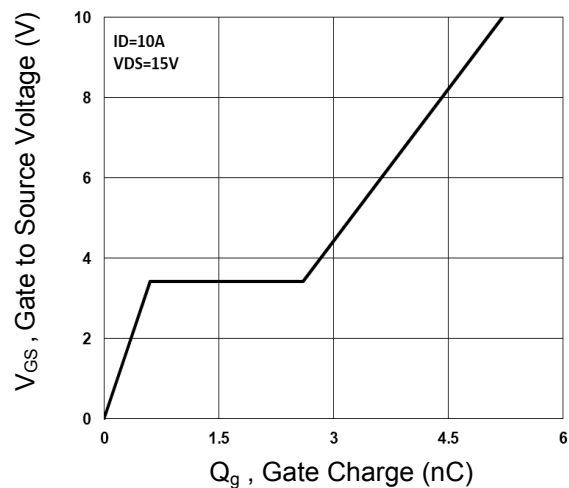

Fig.4 Gate Charge Waveform

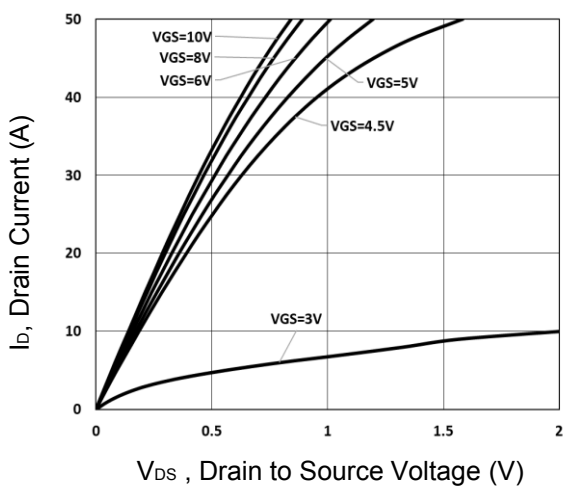

Fig.5 Typical Output Characteristics

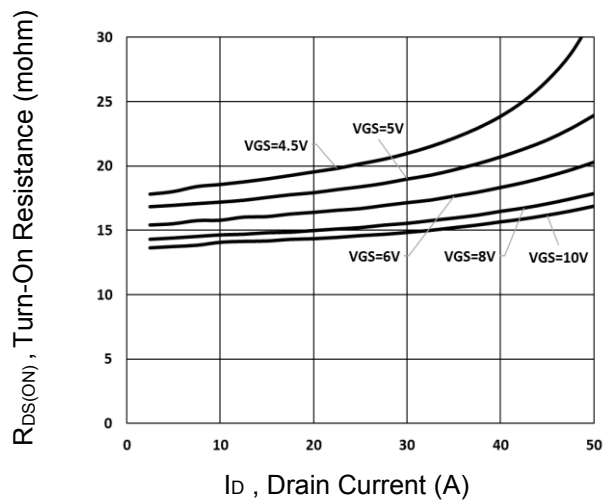

Fig.6 Turn-On Resistance vs. I_D

Typical Electrical and Thermal Characteristic Curves

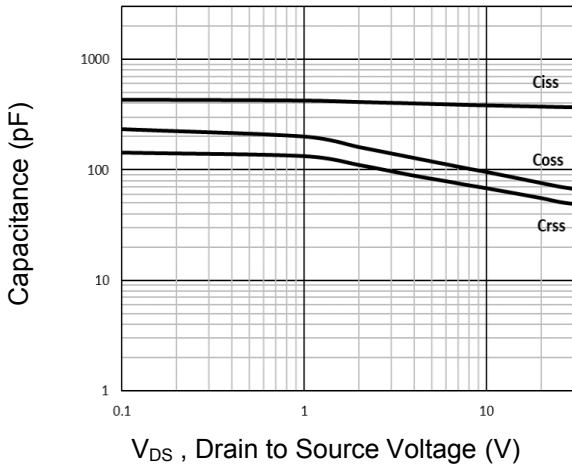

Fig.7 Capacitance Characteristics

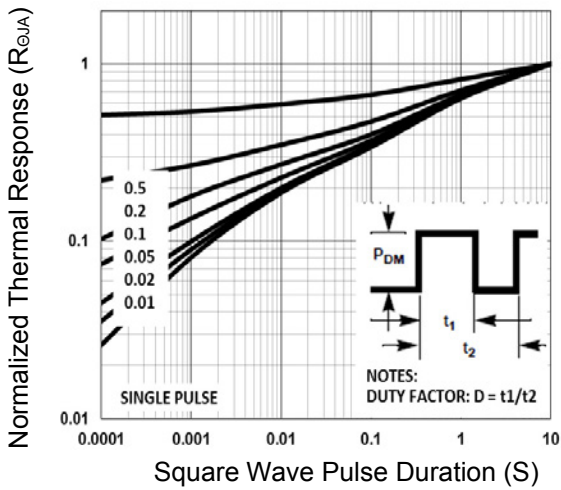

Fig.8 Normalized Transient Response

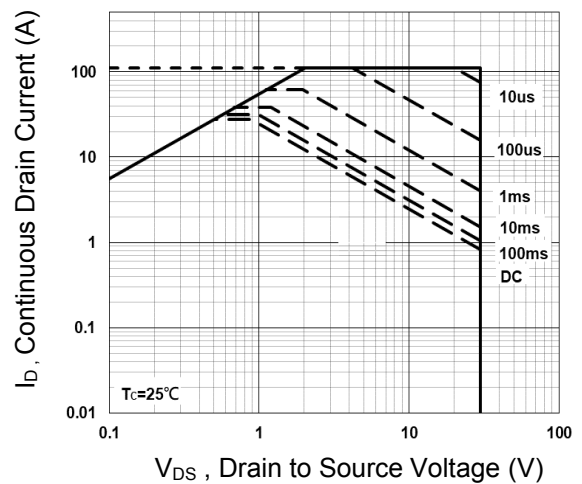

Fig.9 Maximum Safe Operation Area

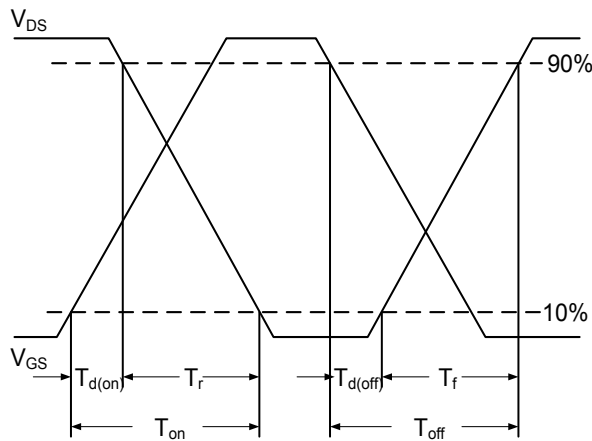

Fig.10 Switching Time Waveform

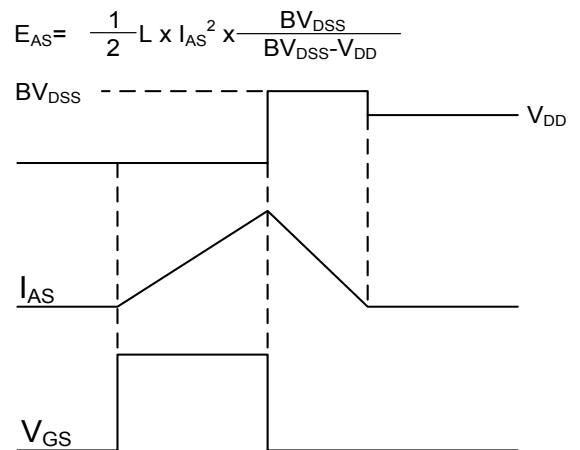
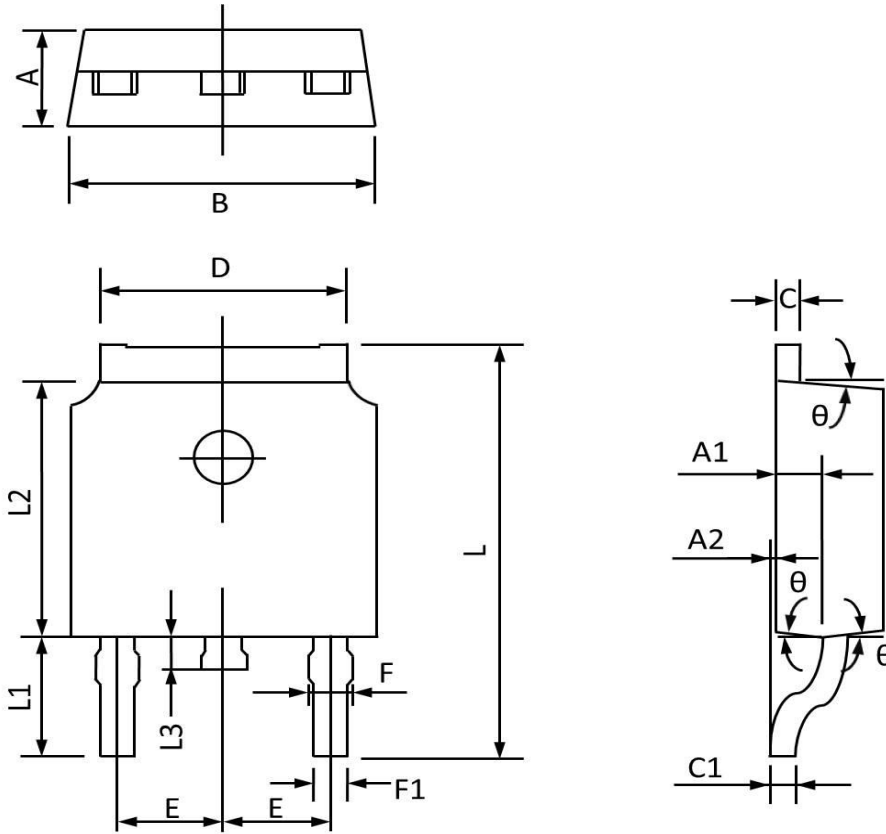

Fig.11 E_{AS} Waveform

Package Outline Dimensions

TO-252 (DPAK)



Symbol	Dimensions In Millimeters		Dimensions In Inches	
	MAX	MIN	MAX	MIN
A	2.400	2.200	0.094	0.087
A1	1.110	0.910	0.044	0.036
A2	0.150	0.000	0.006	0.000
B	6.800	6.400	0.268	0.252
C	0.580	0.450	0.023	0.018
C1	0.580	0.460	0.023	0.018
D	5.500	5.100	0.217	0.201
E	2.386	2.186	0.094	0.086
F	0.940	0.600	0.037	0.024
F1	0.860	0.500	0.034	0.020
L	10.400	9.400	0.409	0.370
L1	3.000	2.400	0.118	0.094
L2	6.200	5.400	0.244	0.213
L3	1.200	0.600	0.047	0.024
θ	9°	3°	9°	3°